

GARMIN▲

G500(H)/G600/G700 TXi

Pilot's Guide



© 2017 - 2020
Garmin International, Inc., or its subsidiaries
All Rights Reserved

Except as expressly provided herein, no part of this manual may be reproduced, copied, transmitted, disseminated, downloaded or stored in any storage medium, for any purpose without the express prior written consent of Garmin. Garmin hereby grants permission to download a single copy of this manual and of any revision to this manual onto a hard drive or other electronic storage medium to be viewed and to print one copy of this manual or of any revision hereto, provided that such electronic or printed copy of this manual or revision must contain the complete text of this copyright notice and provided further that any unauthorized commercial distribution of this manual or any revision hereto is strictly prohibited.

This manual reflects the operation of system software v3.12. Some differences in operation may be observed when comparing the information in this manual to later software versions.

SkyWatch® and Stormscope® are registered trademarks of L-3 Communications.

© 2020 SiriusXM® Satellite Radio, Sirius, SXM and all related marks and logos are trademarks of SiriusXM Radio Inc. All other marks and logos are property of their respective owners. All rights reserved.

Garmin®, FliteCharts®, and SafeTaxi® are registered trademarks of Garmin International or its subsidiaries. ConnexT™, Garmin Pilot™, G5™, GDU™, GTN™, and Smart Airspace™ are trademarks of Garmin International or its subsidiaries. These trademarks may not be used without the express permission of Garmin.

The Bluetooth® word mark and logos are registered trademarks owned by Bluetooth SIG, Inc. and any use of such marks by Garmin is under license. Other trademarks and trade names are those of their respective owners.

© 2020 SD® is a registered trademark of SD-3C, LLC. All rights reserved.

Iridium® is a registered trademark of Iridium Communications, Inc. All rights reserved.

The term Wi-Fi® is a registered trademark of the Wi-Fi Alliance®.

For information regarding the [Aviation Limited Warranty](#), refer to Garmin's website.

For aviation product support, visit flyGarmin.com.

SOFTWARE LICENSE AGREEMENT

BY USING THE DEVICE, COMPONENT OR SYSTEM MANUFACTURED OR SOLD BY GARMIN ("THE GARMIN PRODUCT"), YOU AGREE TO BE BOUND BY THE TERMS AND CONDITIONS OF THE FOLLOWING SOFTWARE LICENSE AGREEMENT. PLEASE READ THIS AGREEMENT CAREFULLY. Garmin Ltd. and its subsidiaries ("Garmin") grants you a limited license to use the software embedded in the Garmin Product (the "Software") in binary executable form in the normal operation of the Garmin Product. Title, ownership rights, and intellectual property rights in and to the Software remain with Garmin and/or its third-party providers. You acknowledge that the Software is the property of Garmin and/or its third-party providers and is protected under the United States of America copyright laws and international copyright treaties. You further acknowledge that the structure, organization, and code of the Software are valuable trade secrets of Garmin and/or its third-party providers and that the Software in source code form remains a valuable trade secret of Garmin and/or its third-party providers. You agree not to reproduce, decompile, disassemble, modify, reverse assemble, reverse engineer, or reduce to human readable form the Software or any part thereof or create any derivative works based on the Software. You agree not to export or re-export the Software to any country in violation of the export control laws of the United States of America.

1 SYSTEM DESCRIPTION	1-1
System Overview	1-2
1.1 Display Layout	1-3
1.2 Display Configurations	1-4
1.3 System Functions	1-7
Pilot Interface	1-8
1.4 Unit Power	1-8
1.4.1 Power Off Options	1-8
1.5 SD Card Slot	1-9
1.6 Touchscreen	1-10
1.6.1 Keys	1-11
1.6.2 Menus	1-12
1.6.3 Lists	1-13
1.6.4 Tabs	1-13
1.6.5 Keypads	1-14
1.7 Control Knobs	1-15
1.7.1 Knob Function Indicators	1-17
1.7.2 Screen Captures	1-18
1.8 Color Conventions	1-19
Databases	1-20
1.9 Database Effective Cycles	1-21
1.10 Active and Standby Databases	1-22
1.11 Manual Updates	1-22
1.11.1 Database Update Page	1-22
1.12 Automatic Updates	1-24
1.13 Database Concierge	1-25
1.14 Database SYNC	1-26
1.15 Chart Streaming	1-27
Connectivity	1-28
1.16 Flight Stream 510 Setup	1-28
1.17 Bluetooth Setup	1-29
1.17.1 Managing Paired Devices	1-29
1.18 Wi-Fi Setup	1-30
1.18.1 Connecting to Wi-Fi	1-30
1.18.2 Viewing Wi-Fi Information	1-31
Pilot Settings	1-32
1.19 Display Brightness Control	1-32
1.19.1 Automatic Brightness Control	1-32
1.19.2 Manual Brightness Control	1-32
1.20 System Status Page	1-33
1.21 Click Volume	1-33
1.22 Clock	1-33
1.23 Weather Display Shortcut	1-33
1.24 Unit Selections	1-34
Crew Profiles	1-35
1.25 Crew Profile Settings	1-35
1.25.1 Crew Profile Management	1-37
System Messages	1-39
1.26 Alerts Types	1-39

Table of Contents

1.26.1 Warnings & Cautions	1-39
1.26.2 System & Function Advisories	1-39
1.26.3 Alert Annunciations	1-40
1.26.4 Pop-up Alerts	1-41
1.26.5 Aural Alerts	1-44
1.27 Advisories	1-45
1.27.1 Audio Advisories	1-46
1.27.2 Battery Advisories	1-46
1.27.3 Database Advisories	1-47
1.27.4 Emergency Descent Mode Advisories	1-48
1.27.5 Engine System Advisories	1-49
1.27.6 Terrain Advisories	1-50
1.27.7 Traffic System Advisories	1-51
1.27.8 Satellite Service Advisories	1-52
1.27.9 PFD Advisories	1-52
1.27.10 System Hardware Advisories	1-55
1.27.11 Weather Service Advisories	1-56
1.28 LRU Failure Annunciations	1-57
1.28.1 PFD Failure Annunciations	1-57
1.28.2 EIS Failure Annunciations	1-58
1.29 GDU Failure Annunciations	1-58
1.29.1 Fan Failure Annunciation, GDU 700()	1-58
1.30 ADS-B Status	1-59
Logs	1-61
1.31 Flight Data Logging	1-61
1.31.1 Exporting to SD Card	1-63
1.31.2 Streaming to Garmin Pilot	1-65
1.32 Exceedance Logging	1-66
1.32.1 Exceedance Alerts	1-68
1.32.2 Exceedance Details	1-69
1.32.3 Exporting to SD Card	1-69
Compatible Equipment	1-70
1.33 Line Replaceable Units	1-70
1.33.1 LRU Status	1-71
1.33.2 Integrated Standby Instrument - Piston Aircraft	1-71
1.33.3 Standby Instruments	1-72
1.33.4 PFD Controller	1-74
1.33.5 Backup Battery	1-75
1.33.6 ADC & AHRS	1-75
1.33.7 PFD Adapter	1-76
1.33.8 Autopilot	1-76
1.33.9 Weather & Music	1-79
1.33.10 Engine Monitoring	1-82
1.33.11 Magnetometer	1-83
1.33.12 Navigation/FMS	1-84
1.33.13 Temperature Probe	1-84
1.33.14 Radar Altimeter	1-85
1.33.15 Traffic	1-86
2 PRIMARY FLIGHT DISPLAY	2-1

PFD Setup	2-3
2.1 Synchronization Options	2-5
2.2 Reference Bugs and Controls	2-6
Flight Instruments	2-9
2.3 Attitude Indicator	2-11
2.3.1 Attitude Sync, Rotorcraft Only	2-13
2.4 Extreme Attitude Indications	2-14
2.5 VNAV Guidance Indications	2-16
2.6 Airspeed Indicator	2-18
2.6.1 Reference Markings	2-20
2.6.2 Reference Speeds	2-21
2.6.3 Fast/Slow Indicator	2-22
2.7 Barometric Altimeter	2-22
2.7.1 Adjusting Barometric Pressure	2-25
2.7.2 Adjusting Selected Altitude	2-26
2.7.3 Temperature Compensation Minimums	2-27
2.7.4 MDA/DH Alerting	2-28
2.8 VSI	2-29
2.8.1 Selected Vertical Speed	2-31
2.9 Horizontal Situation Indicator	2-32
2.9.1 Setting the Heading Bug	2-34
2.9.2 HSI Annunciations	2-35
2.10 CDI	2-38
2.10.1 Course Pointer Types	2-39
2.10.2 Cross Track Error Indication	2-39
2.10.3 CDI Source Selection	2-40
2.10.4 Selected Course with VOR/LOC	2-41
2.10.5 Selected Course with GPS	2-41
2.10.6 Automatic Source Selection	2-42
2.10.7 Auto-Slewing	2-43
2.11 LDI	2-44
2.11.1 Reverse Sensing Correction	2-44
2.12 VDI	2-45
2.12.1 VNAV Deviation Indications	2-46
2.13 CDI/VDI Preview	2-47
Supplemental Flight Data	2-50
2.14 Bearing Pointers	2-50
2.15 GPS NAV Status Field	2-52
2.16 Relative Wind Data	2-53
2.17 Temp/DALT Display	2-54
2.18 DME Display	2-55
2.19 Marker Beacon Symbols	2-56
2.20 AGL Display	2-57
2.20.1 RA Test	2-58
2.21 Clock/Timer	2-58
2.22 GPS Roll Indicator	2-59
3 ADVANCED FEATURES	3-1
HSI MAP	3-2
3.1 HSI Map Overlays	3-4

Table of Contents

3.1.1 Overlay Status Icons	3-6
Map Display, GDU 700L	3-7
3.2 GDU 700L Map Overlays	3-9
3.2.1 Overlay Controls	3-10
3.2.2 Overlay Status Icons	3-11
SVT	3-12
3.3 SVT Setup	3-12
3.4 SVT Features	3-13
3.4.1 Pitch Scale Expansion	3-13
3.4.2 Zero-Pitch Line	3-14
3.4.3 Flight Path Marker	3-14
3.4.4 SVT Terrain and Obstacles	3-15
3.4.5 SVT Runways	3-17
3.4.6 SVT Traffic	3-17
3.4.7 Selectable Display Features	3-18
3.4.8 G500(H) TXi (H)SVT Enablement	3-19
Autopilot	3-20
3.5 GPSS	3-20
3.5.1 GPSS Mode Icons	3-21
3.6 Flight Director	3-22
3.6.1 Command Cues	3-22
3.7 Altitude Preselect Functions	3-24
3.7.1 Arming Altitude Capture	3-24
3.7.2 Enabling Vertical Speed Control	3-24
3.8 Low Bank Mode	3-25
3.9 Servo Heading Reference	3-25
3.10 Mode Annunciations	3-26
3.10.1 AP Basic Mode Annunciations	3-26
3.10.2 AP Lateral & Vertical Mode Annunciations	3-27
3.10.3 Autopilot Alerts	3-28
3.11 Autopilot Preflight Test	3-30
4 MULTI-FUNCTION DISPLAY	4-1
MFD Setup	4-3
4.1 Nearest Airport Criteria	4-3
4.2 MFD Display Size Options	4-4
4.2.1 MFD 40/60% Resize	4-4
4.2.2 MFD Full/Split Screen	4-4
Map	4-5
4.3 Map Interactions	4-8
4.4 Map Views	4-10
4.5 Map Overlays	4-11
4.5.1 Overlay Controls	4-11
4.5.2 Overlay Status Icons	4-14
4.6 Map Detail	4-15
4.7 Map Setup	4-16
4.7.1 Map Selections	4-17
4.7.2 Aviation Selections	4-24
4.7.3 Smart Airspace	4-26
4.7.4 SafeTaxi	4-27

4.7.5 Land Selections	4-29
4.7.6 Traffic Selections	4-30
4.7.7 Weather Selections	4-30
Charts	4-31
4.8 Chart Setup	4-32
4.9 Chart Selection	4-34
4.10 Aircraft Position Icon	4-35
Active Flight Plan	4-36
4.11 Edit Data Fields	4-37
4.12 Collapse All Airways	4-38
4.13 Flight Plan Map Indications	4-39
4.14 VNAV Guidance Indications	4-42
Waypoints	4-45
4.15 Waypoint Information	4-45
4.16 Waypoint Selection	4-48
4.16.1 Waypoint Autofill	4-48
4.16.2 Search Tabs	4-48
SiriusXM Audio Entertainment	4-50
4.17 SiriusXM Audio Activation	4-51
4.18 Browse Music Channels	4-51
4.18.1 Audio Category Selection	4-51
4.18.2 Direct Channel Tuning	4-52
External Video	4-53
4.19 SD Video Setup	4-54
4.19.1 Settings Key	4-54
5 WEATHER AWARENESS	5-1
Weather Display	5-2
5.1 Weather Products	5-3
Datalink Weather	5-5
5.2 Weather Page Interactions	5-6
5.3 Weather Map Views	5-8
5.4 WX Display/Map Settings	5-9
5.5 Weather Product Age	5-10
5.6 Precipitation	5-11
5.6.1 Connex PRECIP	5-12
5.6.2 FIS-B NEXRAD	5-12
5.6.3 SiriusXM NEXRAD	5-14
5.7 Echo Tops	5-15
5.8 Clouds	5-15
5.8.1 Cloud Tops	5-15
5.8.2 IR Satellite	5-16
5.9 Lightning	5-16
5.10 METARs and TAFs	5-17
5.11 Cell Movement	5-18
5.12 AIRMETs	5-19
5.12.1 Textual AIRMETs	5-19
5.12.2 Graphical AIRMETs	5-20
5.13 Center Weather Advisory	5-22
5.14 SIGMETs	5-22

Table of Contents

5.15 County Warnings	5-23
5.16 Cyclone/Hurricane Track	5-23
5.17 AIREP/PIREPs	5-24
5.18 Surface Analysis	5-25
5.19 City Forecast	5-25
5.20 Winds Aloft	5-26
5.21 Icing	5-27
5.22 Turbulence	5-29
5.23 Freezing Levels	5-30
5.24 TFRs	5-31
5.25 SiriusXM	5-32
5.25.1 SiriusXM Weather Setup	5-33
5.25.2 Activating Services	5-34
5.25.3 SiriusXM Weather Products	5-34
5.26 FIS-B Weather	5-35
5.26.1 FIS-B Data Transmission Limitations	5-35
5.26.2 FIS-B Weather Setup	5-37
5.26.3 Raw Text Reports	5-38
5.26.4 FIS-B Ground Reception Status	5-38
5.27 Connex Weather	5-39
5.27.1 Activating Connex Services	5-39
5.27.2 Deactivating Connex Unit Registration	5-40
5.27.3 Connex Weather Product Age	5-40
5.27.4 Connex Weather Setup	5-41
5.27.5 Connex Data Requests	5-42
Stormscope	5-44
5.28 Stormscope Page	5-44
5.29 Stormscope Setup	5-45
5.29.1 Stormscope Modes & Symbols	5-45
5.29.2 Views	5-46
Airborne Weather Radar	5-47
5.30 Weather Radar Page	5-47
5.31 Weather Radar Setup	5-49
5.31.1 Sector Scan	5-49
5.31.2 Stabilization	5-50
5.31.3 WATCH	5-50
5.31.4 Weather Alert	5-51
5.31.5 Altitude Compensated Tilt	5-51
5.31.6 Turbulence Detection	5-52
5.31.7 Ground Clutter Suppression	5-52
5.32 Radar Modes	5-53
5.32.1 Mode Key	5-53
5.33 Radar Controls	5-56
5.33.1 Show Bearing/Tilt	5-56
5.33.2 Bearing	5-56
5.33.3 Tilt	5-57
5.33.4 Scan	5-58
5.33.5 Gain	5-59
5.34 Radar Alerts	5-60

6 TRAFFIC AWARENESS	6-1
Traffic Display	6-2
6.1 Traffic Page	6-3
6.2 Traffic Setup	6-6
6.2.1 Traffic Test	6-6
6.2.2 Altitude Filtering	6-7
Traffic Types	6-8
6.3 TIS-A	6-8
6.3.1 TIS-A Setup Selections	6-8
6.3.2 TIS-A Traffic Symbols	6-9
6.3.3 TIS-A Status Indications	6-9
6.4 TAS/TCAS I	6-10
6.4.1 TAS/TCAS I Setup Selections	6-10
6.4.2 TAS/TCAS I Traffic Symbols	6-10
6.4.3 TAS/TCAS I Status Indications	6-11
6.5 TCAS II	6-12
6.5.1 TCAS II Status Indications	6-12
6.5.2 TCAS II Annunciations	6-13
6.5.3 TCAS II Traffic Symbols	6-15
6.5.4 TCAS II with ADS-B	6-15
6.6 ADS-B	6-16
6.6.1 ADS-B Setup Selections	6-16
6.6.2 ADS-B Traffic Symbols	6-17
6.6.3 ADS-B Traffic Applications	6-18
6.6.4 Motion Vectors	6-19
6.6.5 ADS-B Status Indications	6-19
6.6.6 ADS-B Traffic Interactions	6-20
6.7 Traffic Alerts	6-21
7 TERRAIN AWARENESS	7-1
Terrain Configurations	7-2
7.1 GPS Altitude for Terrain	7-2
7.1.1 GSL Altitude & Indicated Altitude	7-3
7.2 Database Limitations	7-4
Terrain Display	7-5
7.3 Terrain Page	7-5
7.4 Terrain Setup	7-7
7.5 Terrain Proximity	7-8
7.5.1 Terrain Elevation Depictions	7-9
7.5.2 Obstacle Elevation Depictions	7-11
Terrain Alerting	7-13
7.6 Alert Types	7-13
7.6.1 Alerting Thresholds	7-15
7.6.2 Alert Inhibit, TAWS and Terrain-FLTA	7-18
7.7 Terrain-FLTA	7-19
7.7.1 Reduced Protection Mode, Rotorcraft Only	7-19
7.7.2 Terrain-FLTA Alerts	7-20
7.8 TAWS-B	7-23
7.8.1 TAWS-B Alerts	7-23
7.9 External TAWS/HTAWS	7-27

Table of Contents

7.9.1 TAWS-A	7-28
7.9.2 TAWS-A Alerts	7-29
8 FUEL & ENGINE INDICATING SYSTEM	8-1
Reciprocating Engines	8-2
8.1 EIS Display	8-2
8.2 EIS Setup	8-4
8.3 EIS Functions	8-6
8.3.1 Gauge Types	8-8
8.3.2 Markings & Indications	8-10
8.3.3 EGT/CHT Bar Graphs	8-13
8.3.4 Lean Assist Mode	8-14
8.3.5 Selectable User Fields	8-18
8.4 Configuration Report	8-19
Turbine Engines	8-20
8.5 EIS Display	8-20
8.6 EIS Setup	8-22
8.7 EIS Functions	8-23
8.7.1 Gauge Types	8-24
8.7.2 Markings and Indications	8-26
8.7.3 Additional Gauge Features	8-29
8.7.4 Selectable User Fields	8-34
8.8 Configuration Report	8-35
Fuel	8-36
8.9 Fuel Gauges	8-36
8.10 Fuel Computer	8-39
8.10.1 Preset Fuel Quantities	8-40
8.10.2 Fuel Flow Calibration	8-40
Advanced EIS Configurations	8-41
8.11 Fuel Balance Monitoring	8-41
8.12 Automatic Ignition	8-42
8.13 Gauge-Driven Discrete Outputs	8-43
EIS Operations	8-44
8.14 Record Keeping	8-44
8.15 Flight Operations	8-45
8.15.1 Initial Setup	8-46
8.15.2 Preflight	8-47
8.15.3 En Route	8-47
8.15.4 Post Flight	8-47
Engine Advisories & Alerts	8-48
8.16 Engine Advisories	8-48
8.17 Engine Alerts	8-49
9 ABNORMAL OPERATIONS	9-1
Backup Instruments	9-2
9.1 Display Backup	9-2
9.1.1 Standby PFD Display Options	9-3
9.1.2 Composite Display Backup Mode	9-4
9.2 Backup Battery	9-9
9.2.1 Battery Status Indications	9-11
9.2.2 Battery Alerts	9-13

9.3 AHRS & ADC Failures	9-14
9.3.1 AHRS and ADC Sensor Selection	9-15
9.3.2 AHRS Operating In Reversionary Mode	9-17
9.3.3 GPS Failure	9-17
9.3.4 AHRS Alerts	9-18
9.3.5 Miscompare & No Compare	9-21
9.4 HSI Failure Modes	9-23
9.4.1 GPS Failure	9-25
9.4.2 Backup GPS	9-26
Emergency Descent	9-27
9.5 EDM Activation	9-27
9.5.1 Manual Activation	9-28
9.5.2 Automatic Activation	9-28
9.6 EDM Inhibit	9-30
9.7 EDM Override	9-32
9.8 EDM Active Discrete Output	9-33
9.9 EDM Failures	9-33
10 QUALIFICATION	10-1
10.1 Glove Qualification	10-1
11 GLOSSARY	11-1

INTENTIONALLY LEFT BLANK

**WARNING**

DO NOT USE TERRAIN AVOIDANCE DISPLAYS AS THE SOLE SOURCE OF INFORMATION FOR MAINTAINING SEPARATION FROM TERRAIN AND OBSTACLES. GARMIN OBTAINS TERRAIN AND OBSTACLE DATA FROM THIRD PARTY SOURCES AND CANNOT INDEPENDENTLY VERIFY THE ACCURACY OF THE INFORMATION.

**WARNING**

ALWAYS REFER TO CURRENT AERONAUTICAL CHARTS AND NOTAMS FOR VERIFICATION OF DISPLAYED AERONAUTICAL INFORMATION. DISPLAYED AERONAUTICAL DATA MAY NOT INCORPORATE THE LATEST NOTAM INFORMATION.

**WARNING**

DO NOT USE GEOMETRIC ALTITUDE FOR COMPLIANCE WITH AIR TRAFFIC CONTROL ALTITUDE REQUIREMENTS. THE PRIMARY BAROMETRIC ALTIMETER MUST BE USED FOR COMPLIANCE WITH ALL AIR TRAFFIC CONTROL ALTITUDE REGULATIONS, REQUIREMENTS, INSTRUCTIONS, AND CLEARANCES.

**WARNING**

DO NOT USE BASEMAP INFORMATION (LAND AND WATER DATA) AS THE SOLE MEANS OF NAVIGATION. BASEMAP DATA IS INTENDED ONLY TO SUPPLEMENT OTHER APPROVED NAVIGATION DATA SOURCES AND SHOULD BE CONSIDERED ONLY AN AID TO ENHANCE SITUATIONAL AWARENESS.

**WARNING**

DO NOT RELY SOLELY UPON THE DISPLAY OF TRAFFIC INFORMATION TO ACCURATELY DEPICT ALL OF THE TRAFFIC WITHIN RANGE OF THE AIRCRAFT. DUE TO LACK OF EQUIPMENT, POOR SIGNAL RECEPTION, AND/OR INACCURATE INFORMATION FROM AIRCRAFT OR GROUND STATIONS, TRAFFIC MAY BE PRESENT THAT IS NOT REPRESENTED ON THE DISPLAY.

**WARNING**

DO NOT USE DATALINK WEATHER INFORMATION FOR MANEUVERING IN, NEAR, OR AROUND AREAS OF HAZARDOUS WEATHER. INFORMATION CONTAINED WITHIN DATALINK WEATHER PRODUCTS MAY NOT ACCURATELY DEPICT CURRENT WEATHER CONDITIONS.

**WARNING**

DO NOT USE THE INDICATED DATALINK WEATHER PRODUCT AGE TO DETERMINE THE AGE OF THE WEATHER INFORMATION SHOWN BY THE DATALINK WEATHER PRODUCT. DUE TO TIME DELAYS INHERENT IN GATHERING AND PROCESSING WEATHER DATA FOR DATALINK TRANSMISSION, THE WEATHER INFORMATION SHOWN BY THE DATALINK WEATHER PRODUCT MAY BE OLDER THAN THE INDICATED WEATHER PRODUCT AGE.



WARNING

ALWAYS REFER TO CURRENT AERONAUTICAL CHARTS FOR APPROPRIATE MINIMUM CLEARANCE ALTITUDES. THE DISPLAYED MSA_s ARE ONLY ADVISORY IN NATURE AND SHOULD NOT BE RELIED UPON AS THE SOLE SOURCE OF OBSTACLE AND TERRAIN AVOIDANCE INFORMATION.



WARNING

DO NOT USE GPS TO NAVIGATE TO ANY ACTIVE WAYPOINT IDENTIFIED AS A “NON WGS84 WPT” BY A SYSTEM MESSAGE. “NON WGS84 WPT” WAYPOINTS ARE DERIVED FROM AN UNKNOWN MAP REFERENCE DATUM THAT MAY BE INCOMPATIBLE WITH THE MAP REFERENCE DATUM USED BY GPS (KNOWN AS WGS84) AND MAY BE POSITIONED IN ERROR AS DISPLAYED.



WARNING

DO NOT RELY SOLELY UPON THE DISPLAY OF TRAFFIC INFORMATION FOR COLLISION AVOIDANCE MANEUVERING. THE TRAFFIC DISPLAY DOES NOT PROVIDE COLLISION AVOIDANCE RESOLUTION ADVISORIES AND DOES NOT UNDER ANY CIRCUMSTANCES OR CONDITIONS RELIEVE THE PILOT'S RESPONSIBILITY TO SEE AND AVOID OTHER AIRCRAFT.



WARNING

DO NOT RELY ON THE ACCURACY OF ATTITUDE AND HEADING INDICATIONS IN GEOGRAPHIC AREAS WHERE VARIATION IN THE EARTH'S MAGNETIC FIELD EXISTS. THIS INCLUDES: NORTH OF 72° NORTH LATITUDE AT ALL LONGITUDES; SOUTH OF 70° SOUTH LATITUDE AT ALL LONGITUDES; NORTH OF 65° NORTH LATITUDE BETWEEN LONGITUDE 75° W. AND 120° W. (NORTHERN CANADA); NORTH OF 70° NORTH LATITUDE BETWEEN LONGITUDE 70° W. AND 128° W. (NORTHERN CANADA); NORTH OF 70° NORTH LATITUDE BETWEEN LONGITUDE 85° E. AND 114° E. (NORTHERN RUSSIA); SOUTH OF 55° SOUTH LATITUDE BETWEEN LONGITUDE 120° E. AND 165° E. (REGION SOUTH OF AUSTRALIA AND NEW ZEALAND).



WARNING

DO NOT RELY SOLELY UPON DATALINK SERVICES TO PROVIDE TFR INFORMATION. ALWAYS CONFIRM TFR INFORMATION THROUGH OFFICIAL SOURCES SUCH AS FLIGHT SERVICE STATIONS OR AIR TRAFFIC CONTROL.



WARNING

DO NOT RELY ON INFORMATION FROM A LIGHTNING DETECTION SYSTEM DISPLAY AS THE SOLE BASIS FOR HAZARDOUS WEATHER AVOIDANCE. RANGE LIMITATIONS AND INTERFERENCE MAY CAUSE THE SYSTEM TO DISPLAY INACCURATE OR INCOMPLETE INFORMATION. REFER TO DOCUMENTATION FROM THE LIGHTNING DETECTION SYSTEM MANUFACTURER FOR DETAILED INFORMATION ABOUT THE SYSTEM.

**WARNING**

USE APPROPRIATE PRIMARY SYSTEMS FOR NAVIGATION, AND FOR TERRAIN, OBSTACLE, AND TRAFFIC AVOIDANCE. GARMIN SVT IS INTENDED AS AN AID TO SITUATIONAL AWARENESS ONLY AND MAY NOT PROVIDE EITHER THE ACCURACY OR RELIABILITY UPON WHICH TO SOLELY BASE DECISIONS AND/OR PLAN MANEUVERS TO AVOID TERRAIN, OBSTACLES, OR TRAFFIC.

**WARNING**

DO NOT USE THE GARMIN SVT RUNWAY DEPICTION AS THE SOLE MEANS FOR DETERMINING THE PROXIMITY OF THE AIRCRAFT TO THE RUNWAY OR FOR MAINTAINING THE PROPER APPROACH PATH ANGLE DURING LANDING.

**WARNING**

DO NOT USE TAWS INFORMATION FOR PRIMARY TERRAIN OR OBSTACLE AVOIDANCE. TAWS IS INTENDED ONLY TO ENHANCE SITUATIONAL AWARENESS.

**WARNING**

DO NOT RELY SOLELY ON VNAV GUIDANCE WHEN NAVIGATING HORIZONTALLY AND VERTICALLY AROUND USER-DEFINED AIRPORTS. IT IS THE PILOT'S RESPONSIBILITY TO ENSURE SEPARATION FROM TERRAIN AND OBSTACLES DURING AN APPROACH TO A USER-DEFINED AIRPORT.

**CAUTION**

ENSURE THAT ANY UNIT REPAIRS ARE MADE BY AN AUTHORIZED GARMIN SERVICE CENTER. UNAUTHORIZED REPAIRS OR MODIFICATIONS COULD VOID BOTH THE WARRANTY AND AFFECT THE AIRWORTHINESS OF THE AIRCRAFT.

**CAUTION**

DO NOT CLEAN DISPLAY SURFACES WITH ABRASIVE CLOTHS OR CLEANERS CONTAINING AMMONIA. THEY WILL HARM THE ANTI-REFLECTIVE COATING.

**NOTE**

Foreign materials (i.e., moisture, objects) that come into contact with the touchscreen can prevent the unit from responding to touch commands. To restore functionality, wipe the screen dry and/or remove interfering objects.

**NOTE**

Intruder aircraft at or below 500 ft AGL may not appear on the Garmin SVT display or may appear as a partial symbol.



NOTE

All visual depictions contained within this document, including screen images of the system panel and displays, are subject to change and may not reflect the most current system and aviation databases. Depictions of equipment may differ slightly from the actual equipment.



NOTE

The United States government operates the Global Positioning System and is solely responsible for its accuracy and maintenance. The GPS system is subject to changes which could affect the accuracy and performance of all GPS equipment. Portions of the system utilize GPS as a precision electronic NAVAID. Therefore, as with all NAVAIDs, information presented by the system can be misused or misinterpreted and, therefore, become unsafe.



NOTE

This device complies with part 15 of the FCC Rules. Operation is subject to the following two conditions: (1) this device may not cause harmful interference, and (2) this device must accept any interference received, including interference that may cause undesired operation.



NOTE

Interference from GPS repeaters operating inside nearby hangars can cause an intermittent loss of attitude and heading displays while the aircraft is on the ground. Moving the aircraft more than 100 yards away from the source of the interference should alleviate the condition.



NOTE

Use of polarized eye wear may cause the flight displays to appear dim or blank.



NOTE

This product, its packaging, and its components contain chemicals known to the State of California to cause cancer, birth defects, or reproductive harm. This notice is being provided in accordance with California's Proposition 65. If you have any questions or would like additional information, please refer to our website at www.garmin.com/prop65.



NOTE

Operating the system in the vicinity of metal buildings, metal structures, or electromagnetic fields can cause sensor differences that may result in nuisance miscompare annunciations during start up, shut down, or while taxiing. If one or more of the sensed values are unavailable, the annunciation indicates no comparison is possible.

**NOTE**

The system responds to a terminal procedure based on data coded within that procedure in the Navigation Database. Differences in system operation may be observed among similar types of procedures due to differences in the Navigation Database coding specific to each procedure.

**NOTE**

The FAA has asked Garmin to remind pilots who fly with Garmin database-dependent avionics of the following:

- It is the pilot's responsibility to remain familiar with all FAA regulatory and advisory guidance and information related to the use of databases in the National Airspace System.
- Garmin equipment will only recognize and use databases that are obtained from Garmin or Jeppesen. Databases obtained from Garmin or Jeppesen that have a Type 2 LOA from the FAA are assured compliance with all data quality requirements (DQRs). A copy of the Type 2 LOA is available for each applicable database and can be viewed at flyGarmin.com by selecting "Aviation Database Declarations."
- Use of a current Garmin or Jeppesen database in your Garmin equipment is required for compliance with established FAA regulatory guidance, but does not constitute authorization to fly any and all terminal procedures that may be presented by the system. It is the pilot's responsibility to operate in accordance with established AFM(S) and regulatory guidance or limitations as applicable to the pilot, the aircraft, and installed equipment.

**NOTE**

The pilot/operator must review and be familiar with Garmin's database exclusion list as discussed in SAIB CE-14-04 to determine what data may be incomplete. The database exclusion list can be viewed at flyGarmin.com by selecting "Database Exclusions List."

**NOTE**

The pilot/operator must have access to Garmin and Jeppesen database alerts and consider their impact on the intended aircraft operation. The database alerts can be viewed at flyGarmin.com by selecting "Aviation Database Alerts."

**NOTE**

If the pilot/operator wants or needs to adjust the database, contact Garmin Product Support.



NOTE

Garmin requests the flight crew report any observed discrepancies related to database information. These discrepancies could come in the form of an incorrect procedure; incorrectly identified terrain, obstacles and fixes; or any other displayed item used for navigation or communication in the air or on the ground. Visit flyGarmin.com and select "Aviation Data Error Report."



NOTE

When using autopilot to fly an approach with vertical guidance, the autopilot will not level the aircraft at the MDA/DH even if the MDA/DH is set in the altitude preselect.



NOTE

Information obtained solely through FIS-B does not replace a thorough preflight briefing. NOTAMs received via FIS-B uplink may not be a complete listing. Active NOTAMs are removed from the FIS-B data stream 30 days after issuance. FIS-B uplink is not an FAA approved source for NOTAMs.



NOTE

When using Stormscope, there are several atmospheric phenomena in addition to nearby thunderstorms that can cause isolated discharge points in the strike display mode. However, clusters of two or more discharge points in the strike display mode do indicate thunderstorm activity if these points reappear after the screen has been cleared.



NOTE

The navigation databases used in Garmin navigation systems contain Special Procedures. Prior to flying these procedures, pilots must have specific FAA authorization, training, and possession of the corresponding current, and legitimately-sourced chart (approach plate, etc.). Inclusion of the Special Procedure in the navigation database DOES NOT imply specific FAA authorization to fly the procedure.

Record of Revision

REVISION	DATE	CHANGE DESCRIPTION
A	05.19.17	Initial Release.
B	01.16.18	Production Release.
C	01.18.18	Minor edits.
D	01.24.18	Minor edits.
E	08.17.18	Updates for software v2.20.
F	10.16.18	Updates for software v2.30.
G	03.14.19	Updates for software v3.00.
H	05.21.19	Updates for software v3.01.
J	10.15.20	Updates for software v3.12.

Available for Download

Electronic Pilot's Guide

A version of this guide saved in Adobe Acrobat. Available for viewing on your computer or portable device.

Upgrade Supplement

Details document changes for software enhancements.

Go to garmin.com/manuals

Layout

SECTION	TITLE
1	System Description
2	Primary Flight Display
3	Advanced Features
4	Multi-Function Display
5	Weather Awareness
6	Traffic Awareness
7	Terrain Awareness
8	Fuel & Engine Indicating System
9	Abnormal Operations
10	Qualification
11	Glossary

The layout and design of this guide is intended to provide clear, concise sections written in the logical order of a pilot's flight instrument and systems scan.

Special Notations

This guide uses the following message types when applicable.



WARNING

Indicates when serious injury or death will occur.



CAUTION

Indicates when equipment damage is possible.



NOTE

Emphasizes a point about a specific feature, function, or operation.

Insets

These boxes may include a list of features or application functions, references to additional information, or a useful pilot's tip.

Reference Manuals

DOCUMENT	P/N
<i>GDL 69/69A SiriusXM Satellite Radio Activation Instructions</i>	190-00355-04

Reference Websites

WEBSITE	ADDRESS
Aviation Limited Warranty	https://www.garmin.com/en-US/legal/aviation-limited-warranty
Database Concierge	Go to http://www.flygarmin.com/support and select Database Management.
ADS-B Academy	https://www.garmin.com/us/intheair/ads-b
Connex	http://www.garmin.com/connex

1 System Description

SYSTEM OVERVIEW

1.1	Display Layout	1-3
1.2	Display Configurations	1-4
1.3	System Functions	1-7

PILOT INTERFACE

1.4	Unit Power	1-8
1.5	SD Card Slot	1-9
1.6	Touchscreen	1-10
1.7	Control Knobs	1-15
1.8	Color Conventions	1-19

DATABASES

1.9	Database Effective Cycles	1-21
1.10	Active and Standby Databases	1-22
1.11	Manual Updates	1-22
1.12	Automatic Updates	1-24
1.13	Database Concierge	1-25
1.14	Database SYNC	1-26
1.15	Chart Streaming	1-27

CONNECTIVITY

1.16	Flight Stream 510 Setup	1-28
1.17	Bluetooth Setup	1-29
1.18	Wi-Fi Setup	1-30

PILOT SETTINGS

1.19	Display Brightness Control	1-32
1.20	System Status Page	1-33
1.21	Click Volume	1-33
1.22	Clock	1-33
1.23	Weather Display Shortcut	1-33
1.24	Unit Selections	1-34

CREW PROFILES

1.25	Crew Profile Settings	1-35
------	-----------------------------	------

SYSTEM MESSAGES

1.26	Alerts Types	1-39
1.27	Advisories	1-45
1.28	LRU Failure Annunciations	1-57
1.29	GDU Failure Annunciations	1-58
1.30	ADS-B Status	1-59

LOGS

1.31	Flight Data Logging	1-61
1.32	Exceedance Logging	1-66

COMPATIBLE EQUIPMENT

1.33	Line Replaceable Units	1-70
------	------------------------------	------

System Overview

The G500(H)/G600/G700 TXi is a display and sensor system available in three display options.

- GDU 1060 – 10" display
- GDU 700P – 7" portrait display
- GDU 700L – 7" landscape display

Depending on system specifics one or more of the following functions may apply:

- Primary Flight Display (PFD) – provides attitude, heading, air data, and navigation information to the pilot
- Multi-Function Display (MFD) – provides pilot awareness of factors that may affect the overall conduct of a flight
- Engine Indicating System (EIS) – provides engine and airframe operating parameters to the pilot

GDU 1060 PFD/MFD, EIS OPTION

The GDU 1060 provides an MFD or PFD/MFD display with an optional EIS function. Each function is designated to a portion of the display. When configured as an MFD, the system can display two MFDs, or you can expand one MFD to fill the screen. When configured as a PFD/MFD, the MFD can be selectively hidden or shown. When hidden, the PFD expands into the MFD space. If configured as a PFD/MFD or MFD with EIS, the EIS function is always visible on either the left or right edge of the display.

GDU 700P PFD, MFD, EIS, MFD/EIS

The GDU 700P provides a single PFD, MFD, EIS, or, in single-engine piston EIS, a combined MFD/EIS function. In some installations, it provides backup PFD or EIS information in the event that the primary PFD or EIS display fails or malfunctions. When configured as an MFD/EIS display, engine instruments are dedicated to 40% of the screen. The remaining screen portion displays all configured MFD options using a pilot-selectable menu.

GDU 700L PFD, EIS, OR MFD/EIS

The GDU 700L provides a single PFD, piston EIS, or in single-engine piston EIS, MFD/EIS combined function. When configured as an MFD/EIS display, engine instruments are dedicated to 40% of the screen. The remaining screen portion displays all configured MFD options using a pilot-selectable menu.

1.1 Display Layout



Garmin Display Units

DISPLAY HARDWARE DESCRIPTIONS	
Bezel	Includes the Power key, mechanical knobs, photocell, and SD card slots. Ledges provide hand stability when performing data entry and making selections.
Touchscreen	Multi-touch display provides controls for unit operation.
Power Key	Powers the unit on or off. Allows manual transition into display backup mode.
Photocell	Measures cockpit ambient light level to automatically adjust display brightness for day and night.
SD Card Slots	Each unit has two SD card slots. Each slot's purpose depends on display type.
Inner & Outer Knobs	Units have a dual concentric knob near the bottom of bezel. GDU 1060 has two, one on each side. Inner and outer knob functionality differs according to display features.

1.2 Display Configurations

GDU 1060 DISPLAY CONFIGURATIONS



PFD Only



PFD/EIS



MFD (40%)/PFD (60%)



MFD/PFD/EIS



MFD/MFD



MFD/MFD/EIS

GDU 700P DISPLAY CONFIGURATIONS



EIS Only



PFD Only



MFD Only



EIS/MFD [1]

[1] Single-engine piston EIS only.

GDU 700L DISPLAY CONFIGURATIONS



Piston EIS Only



PFD Only



Single Engine Piston EIS/MFD

1.3 System Functions

PFD	MFD	EIS [2]
GDU 700()/1060	GDU 700P/1060 [3]	GDU 700()/1060 [3]
<ul style="list-style-type: none"> • Attitude • Airspeed • Altitude • Vertical Speed • Turn Coordinator • HSI • HSI Map [4] • Clock • Lateral and Vertical Deviation Indicators • Datalink Weather Display [1] • Radar Altimeter [1] • Autopilot Annunciations [1] • Flight Director [1] • Synthetic Vision [1] • Flight Path Marker [1] • System Advisories • Safety Monitors [1] • GPS NAV Status • Display Backup [1] [4] • Terrain Avoidance [1] 	<ul style="list-style-type: none"> • Navigation Map • Traffic [1] • Terrain • Charts • Flight Plan • Weather [1] • Waypoint Information • Music Services [1] • Terrain Avoidance [1] • Engine Data [1] • System Advisories • Video [1] 	<ul style="list-style-type: none"> • Fuel Qty (Main, Aux) • RPM/Tach • Propeller Sync Display • Manifold Pressure • Oil Pressure • Oil Temperature • Shaft Horsepower [5] • Percent Power • Fuel Flow • Fuel Pressure • Fuel Calculations • Cylinder Operating Temperatures (CHT, EGT) • TIT • Lean Assist Mode • Carburetor Air Temperature • Intercooler Temperatures (IAT, CDT, Difference) • Amps/Volts • User Selectable Fields • User Adjustable Advisories • Torque [5] • Turbine Temperature [5] • Vacuum/Pressure • Flight Control Trim Position

[1] Function availability dependent upon aircraft interfaces or enablement.

[2] Displayed engine operating parameters dependent upon configuration.

[3] GDU 700() MFD/EIS provides the same MFD and EIS functionality listed with the exception of weather radar and multi-engine.

[4] Not available for GDU 700L.

[5] Turboprop only.

Pilot Interface

1.4 Unit Power

The GDU receives power directly from the aircraft's electrical system. To ensure safe operation, continuous built-in test features exercise the unit's processor, memory, external inputs, and outputs.

System failure annunciations typically disappear within the first 30 seconds after power-up. Upon power-up, the bezel key backlight momentarily illuminates.

On MFD: The start-up screen presents the unit software version, the name and status of all installed databases, and controls for selecting a crew profile.

1.4.1 Power Off Options



WARNING

NEVER ATTEMPT TO POWER OFF THE UNIT WHILE AIRBORNE UNLESS OPERATIONAL PROCEDURES DICTATE.



Pushing the **Power** key once opens a pop-up menu. Selectable display options allow you to:

- Power off unit
- Close the menu (cancels shutdown)
- Change operating mode to display backup (if available)



Pushing and holding the **Power** key for 4 seconds powers off the unit without safeguards. Shutdown occurs once the timer reaches zero.

1.5 SD Card Slot



NOTE

Do not remove or insert an SD card while in flight. Always verify the system is powered off before inserting or removing an SD card.

Determine which card slot is appropriate for the task.

TASK	SD CARD SLOT		
	GDU 1060	GDU 700P	GDU 700L
Exporting data logs	Top	Top	Left
Saving system configurations	Top	Top	Left
Transferring crew profiles	Top	Top	Left
Capturing screen images [1]	Top	Top	Left
Upgrading software [4]	Top	Top	Left
Enabling Flight Stream 510 connectivity [2]	Bottom	Bottom	Right
Updating databases [3]	Top or bottom	Top or bottom	Left or right

- [1] Screen images save to the bottom/right card when the top/left card is unavailable.
 [2] Install Flight Stream 510 in a GTN, if available.
 [3] While either slot may be used, the bottom/left slot has a faster transfer rate and is recommended for all database-related tasks.
 [4] An installer unlock card must be present in the bottom/right card slot to perform a software update.

INSERT AN SD CARD

When inserting an SD card:

1. Verify unit power is off and the slot is empty.
2. Hold card in the proper orientation.
 - **GDU 1060/700P:** label faces left edge of display screen
 - **GDU 700L:** label faces top edge of display screen
3. Ensure back edge of card is flush with display bezel after insertion.

EJECT AN SD CARD

1. Power off the unit.
2. Release the spring latch by pressing lightly on exposed edge of card.

1.6 Touchscreen

GESTURES

TAP



Touching the screen briefly with a single finger.

Use this gesture for:

- Opening a page or menu
- Activating a command key or data entry field
- Displaying map feature information
- Selecting an option within an application

TAP AND HOLD



Certain momentary controls (e.g., directional arrow keys) provide a secondary tap and hold function.

Tap the key and hold your finger in place until the desired action occurs.

Use this gesture for:

- Scrolling with arrow keys
- Enabling Caps Lock
- Increasing/decreasing values continuously

SWIPE



A smooth motion that involves touching an object, then sliding your finger across the screen and lifting up.

Use this gesture for:

- Viewing and scrolling lists
- Panning across a map or chart display
- Zooming HSI map or rotorcraft PFD VFR map display (upward and downward swipes only)

FLICK



Swiping the screen in a quick upward or downward motion. Information moves at a fast speed (faster than by holding the arrow key), then slows to a stop.

Use this gesture for:

- Scrolling an item list

PINCH & STRETCH



Touch any map or chart with two fingers at the same time, then bring the fingers close together (pinch) or spread them apart (stretch). Just remember: stretch to zoom in and pinch to zoom out.

Use this gesture for:

- Magnifying map features
- Identifying multiple objects in close proximity
- Reading details on a chart
- Magnifying a video image

1.6.1 Keys

COMMON COMMANDS



Displays Advisories page. Blinking icon indicates unread system advisories.



Inputs specified value.



Displays context menus.



Scrolls up.



Returns to previous page.



Scrolls down.



Cancels current function without inputting data.



Indicates corresponding item is selected (e.g., database update)



Adjusts MFD and PFD display sizes between 40% and 60% [1]



Switches display to full screen [1]



Switches from full PFD to split MFD and PFD [1]



Switches from full MFD to split dual MFDs [1]

[1] GDU 1060 only.

FUNCTION KEYS



On

Off

Toggle keys turn a specific function on or off. The current state of the function is indicated below the key label.

1.6.2 Menus

Fly-out menus and slide over windows group related controls into an expandable pane, allowing access to multiple functions on a single page.

Tapping the underlying page closes the menu.

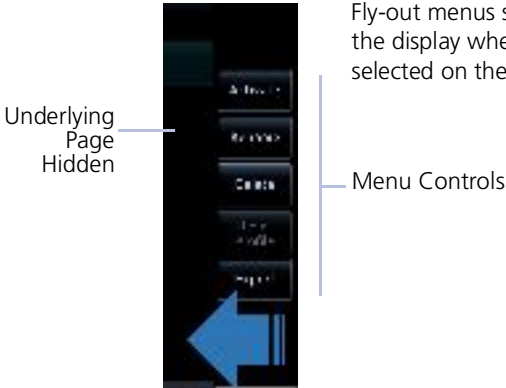

Fly-out menus slide out from the right side of the display when an object or menu item is selected on the underlying page.



Slide over windows slide up from the bottom of display.

1.6.3 Lists



Scrollable lists group control keys related to a single function (e.g., selectable range options). When scrolling, all keys in the list are inactive.

Scroll Bar



Popup lists open to the default or previously selected value.

Default or Current Setting

1.6.4 Tabs

Inactive Tabs



Tabs group information into individual panes. Content includes scrolling lists, data fields, function keys, or a combination of controls.

Tabs are located along the left side or bottom edge of a pane.

Toggle Keys



Lists containing a combination of controls typically appear within a tab and open to the first list item.

Toggle keys either enable or disable list items. In some cases, **Settings** or **Range** keys provide access to selectable setting options.

1.6.5 Keypads

The GDU employs multiple keypad types to serve specific settings and functions.



Numeric



Alphanumeric



QWERTY

Tapping **Layout** changes the format between ABCDE and QWERTY.

1.7 Control Knobs



Inner and outer knobs offer an alternative method for selecting and modifying data without the use of touch keys.

GDU 1060: The dual-concentric knobs control the adjacent PFD or MFD display by default.

PFD KNOB FUNCTIONS	
Outer Knob	<ul style="list-style-type: none"> • Selecting reference controls • Cursor placement and initial field/page selections • Moving cursor forward or backward within data field
Inner Knob (Turn)	<ul style="list-style-type: none"> • Selecting reference values • Inputting data • Modifying individual characters in data entry field
Inner Knob (Push)	<ul style="list-style-type: none"> • Entering current or specified numerical value • Synchronizing PFD reference to its current value • Alternating between standard and pilot set barometric pressure
MFD KNOB FUNCTIONS	
Outer Knob	<ul style="list-style-type: none"> • Selecting a page shortcut • Cursor placement and initial field/page selections • Moving cursor forward or backward within data field
Inner Knob (Turn)	<ul style="list-style-type: none"> • Inputting data • Modifying individual characters in data entry field • Zooming • Controlling weather radar range
Inner Knob (Push)	<ul style="list-style-type: none"> • Entering a specified numerical value
Inner Knob (Push and Hold)	<ul style="list-style-type: none"> • Switch between MFD and PFD control functions

EIS KNOB FUNCTIONS

EIS KNOB FUNCTIONS	
Outer Knob	<ul style="list-style-type: none">• Cursor placement and initial field/page selections• Moving cursor forward or backward within data field
Inner Knob (Turn)	<ul style="list-style-type: none">• Inputting data• Modifying individual characters in data entry field
Inner Knob (Push)	<ul style="list-style-type: none">• Entering a specified numerical value

Dual-Knob PFD Control

For convenience, you may use both knobs to control the PFD. Pushing and holding the inner knob adjacent to the MFD toggles focus between MFD and PFD control functions. MFD control is still available via touchscreen. This feature is particularly useful if your cockpit configuration makes it difficult to access the PFD knob.

1.7.1 Knob Function Indicators

A locator bar works in conjunction with the outer knob providing quick access to the indicated MFD page and/or PFD bug.

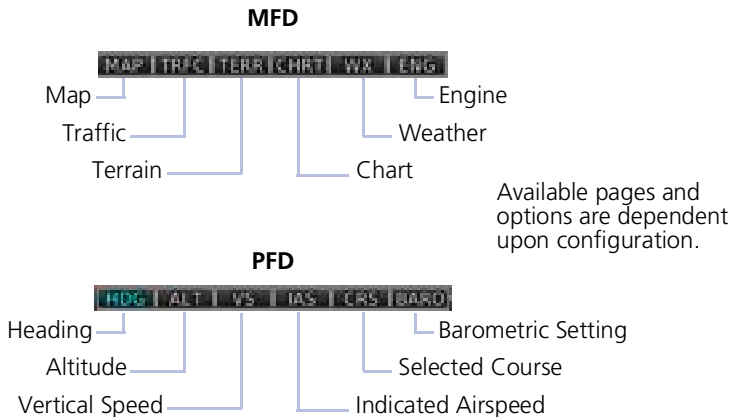

Turning the outer knob clockwise or counter-clockwise moves the locator through displayed menu options. Changes in the current screen configuration may result in a change of menu options. When the knob adjacent to the MFD is controlling the PFD, its locator bar displays PFD menu options.

Additional icons located to the left or right of the bar indicate available knob functions for the associated display.



1.7.2 Screen Captures

Save images to an SD card at any time using a screen capture. Images automatically save to the “print” folder in the SD card root directory.



1. Verify unit power is off.
2. Insert an SD card into the top or left card slot.
3. Power on the unit and go to the page of interest.
4. Push and hold the right inner knob.
5. With knob depressed, push and release the **Power** key.

A camera icon momentarily shows in the annunciator bar indicating a successful screen capture. To view saved images, remove the SD card and open the “print” folder on a computer.

1.8 Color Conventions



Red

- Warning conditions
- Operating limits



Yellow

- Cautionary conditions
- Conditional operating ranges



Green

- Safe operating conditions
- Normal operating ranges
- VOR/localizer data
- Engaged modes



White

- Scales and markings
- Current data and values
- Armed modes



Magenta

- GPS data
- Active flight plan legs
- VNAV data



Cyan

- Pilot-selectable references
- Glide range and best glide path



Gray

- Missing or expired data
- Product unavailable



Blue

- Sky
- Water



Brown

- Ground

Databases



NOTE

The GDU supports SD cards in the FAT32 format only, with capacities ranging between 8 GB and 32 GB.

Databases are stored in the internal memory of each display. To view update cycles, or to purchase individual databases or database packages, go to flyGarmin.com.

The TXi system offers three methods for loading and updating databases:

1. Load databases via SD card. The card can be removed after loading.
2. Transfer databases from a GTN or another GDU using Database SYNC.
3. Transfer databases from a mobile device using Database Concierge and a Flight Stream 510 wireless datacard.

SUPPORTED DATABASES	
Airport Directory	Airport facility and FBO information
Basemap	Bodies of water, geopolitical boundary, and road information
ChartView [1]	Jeppesen terminal procedures
FliteCharts	AeroNav terminal procedures
IGRF [2] [3]	Internal ADAHRS and external AHRS correct for variations in the earth's magnetic field by applying calculations derived from the IGRF database
Navigation	Airport, NAVAID, waypoint, and airspace information (Garmin or Jeppesen)
Obstacles	Obstacle and wire data
SafeTaxi	Airport surface diagrams
Terrain	Terrain elevation data

[1] Optional third party database.

[2] When updated, the database is packaged with the Navigation database. Not available for individual download.

[3] For magnetic field model version and part number information, refer to the AHRS section of the External LRUs page.

For information regarding third party databases, go to jeppesen.com.

1.9 Database Effective Cycles

FUNCTIONAL REQUIREMENTS

- External or internal GPS navigator for system to determine database effectiveness

OR

- Flight Stream 510 wireless datacard
- Garmin Pilot app on a mobile device

FUNCTIONAL LIMITATIONS

- EIS units do not support database functionality

Most databases expire at regular intervals. Exceptions include Basemap and Terrain, which neither expire nor update on a regular schedule. IGRF updates occur approximately every five years. Failure to update a database can lead to errors in heading information.

DATABASE EFFECTIVE STATUS	
Databases with no effective date	<ul style="list-style-type: none"> • Effective upon release • Transfer occurs prior to database verification at system start-up • No automatic transfer if Flight Stream 510 is present • Includes Basemap and Terrain • No pilot confirmation or restart required
Databases with specified effective dates	<ul style="list-style-type: none"> • Effective during a specific period • GDU determines database status using the current date and time from GPS • Automatic activation occurs on the effective date

Navigation	1613, Expires 05-JAN-17
Basemap	16M1
Obstacle/HOT	16B6, Expires 05-JAN-17
Terrain	15T1
SafeTaxi	1656, Expires 05-JAN-17
FliteCharts	1613, Expires 05-JAN-17
Airport Directory	16D6, Expires 05-JAN-17
SafeTaxi	1654, Eff. 21-JUL-16 to 15-SEP-16
FliteCharts	1608, Eff. 26-MAY-16 to 23-JUN-16
Airport Directory	16D4, Eff. 21-JUL-16 to 15-SEP-16
Terrain	Database Not Found

On MFD: The start-up page lists all currently installed databases. Review this list for current database types, cycle numbers, and expiration dates.

Yellow text denotes when a database is:

- Not available
- Installed before its effective date
- Missing date information
- Past its expiration date

Pilot PFD Navigation database expires on 15-SEP-16

Expired database notifications indicate as system advisories.

1.10 Active and Standby Databases

The GDU uses two types of databases: active and standby. Active databases are in use by the system. Standby databases have not reached the effective date. During normal operation, information about all active and standby databases are viewable on the associated tab.

On MFD, tabs are located on System Status page. They are located on Databases page of the PFD (GDU 700() only).

TAB	DISPLAYS
ACTIVE	<ul style="list-style-type: none"> Information about databases currently in use
STANDBY	<ul style="list-style-type: none"> Information about databases that are not yet effective If a standby database is not available, the “No standby databases found” message displays in the Standby tab

1.11 Manual Updates

FUNCTIONAL LIMITATIONS

- The Database Update page is available only when the aircraft is on ground

1.11.1 Database Update Page

This page presents a list of all available databases. It is accessible at any time for review purposes or manual database transfers.



To access the page, tap **Update**.

On MFD, this key resides in the System Status menu.

GDU 700() only: On PFD, it resides on the Databases page.

DATABASE SOURCE INDICATION

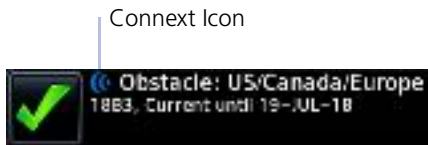

A Connex icon indicates when a database is from Garmin Pilot via wireless transfer.

No indication means the database is either from an SD card or the unit’s internal standby queue.

SELECT ALL DATABASES



Select applicable database(s) for transfer. If all listed databases require updating, choose **Select All**.

Tapping **Select None** deselects all databases.

By default, this page displays only the databases recommended for update.



A message informs when no recommended databases are available.



After all selections are made, initiate the update process by tapping **Start**. GDU automatically restarts once all updates are complete.

SHOW ALL DATABASES

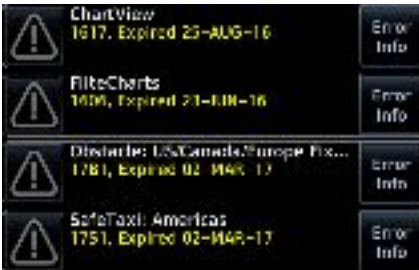

Tapping **Show All** displays a complete list of all databases, including ones that are not yet effective or that may be older than the currently active database(s).

For more details about a specific database, tap **Error Info**.

1.12 Automatic Updates

Automatic updates occur when...

- A newer database is detected on the SD card or in the internal standby queue
- A newer database is within its effective dates
- The aircraft is on ground

When a newer database is available, follow the on-screen prompts to complete the update process. PFD issues a pop-up notification only on the GDU 700(). MFD automatically redirects to the Database Update page.

A status page displays a progress bar and the name of each database as it uploads to the GDU. Terrain and chart databases may require up to 5 minutes each for transfer. Total transfer time depends on the SD card type.

The unit automatically restarts once the update is complete. The update is indicated in the list of currently installed databases.

INSTALL OR UPDATE A DATABASE USING AN SD CARD

1. Download a database onto an SD card.
2. Insert the SD card with the most recent database(s) into the top/right card slot.
3. Power on the GDU.



Selecting **Update** opens the Database Update page. A list displays the newest databases recommended for update.

All newer databases (effective and expired) transfer from the SD card to the internal standby queue.

Overwriting SD card database files

When database files are loaded to the SD card, any previously loaded database files of the same type residing on the SD card will be overwritten. This includes loading a database of a different coverage area or data cycle than that currently residing on the SD card.

BASEMAP, CHARTVIEW, AND TERRAIN UPDATES

These databases automatically transfer from an SD card without any prompting or progress indications. They do not require pilot confirmation or a unit restart.

1.13 Database Concierge

FEATURE REQUIREMENTS

- Flight Stream 510 wireless datacard
- Garmin Pilot app on a mobile device



Database Concierge allows wireless transfer of databases from a mobile device.

A pilot selects and downloads databases inside the Garmin Pilot app. Transfers occur once Flight Stream 510 establishes a wireless connection inside the aircraft.

Database Concierge Transfer Function

- Provides automatic updates for databases with effective dates
- Preloads databases that are not yet effective by placing them in the internal standby queue
- Supports Database SYNC with capable Garmin avionics
- Displays database type, cycle, effective date, and transfer progress
- Allows manual operation via **Start** key
- Requires pilot confirmation

TRANSFER A DATABASE USING DATABASE CONCIERGE

1. Purchase database(s) from flyGarmin.com.
2. Open Garmin Pilot and follow the download instructions.
3. Install Flight Stream 510 into the GDU. If the system contains a GTN, install the datacard into that unit instead.
4. Connect to Wi-Fi.
5. Follow the on-screen prompts.



Database Concierge transfers databases from the app to Flight Stream 510. A progress bar shows when this process is complete.

GDU either updates or preloads databases based on their effective date. A second progress bar indicates upload status. The unit automatically restarts upon database activation.

Tapping **Skip** cancels any unfinished wireless transfers and initiates the update process.

GDU activates any databases that completed transfer before the interruption. Previously selected databases on an SD card or in the internal standby update as well.

The message “Transfers interrupted” displays if no databases are available.

1.14 Database SYNC

FEATURE LIMITATIONS

- Not applicable to Terrain database
- Functionality not available for EIS-only configurations

Database SYNC minimizes database maintenance by synchronizing active and standby databases across all configured LRUs. Once a standby database becomes effective, each LRU automatically generates an update prompt.

For information regarding database packages, and individual database purchases, visit flyGarmin.com.

TOGGLE DATABASE SYNC ON OR OFF

Toggleing the function off disables Chart Streaming (if enabled).

From the 700P/1060 MFD home screen:

Tap **System > System Status > Menu > Database SYNC**

From the 700L MFD home screen:

Tap **System > System Status > Database Information > Menu > Database SYNC**

From the 700() PFD home screen:

Tap **Menu > System > PFD Setup > Database SYNC**

Database SYNC Transfer Function

- Enables automatic database synchronization across all capable Garmin avionics (e.g., GTN or G500/G600 legacy flight displays)
- Includes active and standby databases
- Informs you that enabling Database SYNC may overwrite any databases currently in standby
- Prompts unit restart if a new database is effective and the aircraft is on ground

1.15 Chart Streaming

FEATURE LIMITATIONS

- Available only when Database SYNC is active and a current chart database is available

Chart Streaming allows streaming of individual charts on an as-needed basis until database sync is complete. A typical chart database may take up to one hour to synchronize across multiple LRUs.

Toggleing the function off has no affect on Database SYNC.

Chart Streaming Transfer Function

- Enables automatic streaming of individual charts from the newest chart database
- LRUs with chart streaming enabled display the most current chart information
- Current charts display on MFD Charts page; chart overlays are available for display on Map page
- Chart database effective date displays on Charts page when chart expires
- Available for both ChartView and FliteCharts

Connectivity

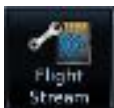

Data logs transfer via Bluetooth wireless technology. Databases transfer over Wi-Fi.

FEATURE REQUIREMENTS

- Flight Stream 510 wireless datacard (installed in GTN, if available)

FEATURE LIMITATIONS

- GDU allows pairing of up to 13 Bluetooth enabled devices, with two simultaneous device connections
- Auto reconnect function is not available for Android devices
- GDU does not support Flight Stream 510 Phone/SMS and flight plan transfer functionality

1.16 Flight Stream 510 Setup

Setup page features allow you to:

- View Flight Stream 510 product information
- Enable database updates
- Pair and manage Bluetooth enabled devices
- View and edit Bluetooth enabled device name and Wi-Fi information



Refer to the Information window when contacting customer service regarding Flight Stream 510.

Product information includes:

- Software version
- Part number

DATABASES

This feature allows automatic import of available database updates via Database Concierge.

1.17 Bluetooth Setup

Depending on display type, Bluetooth device management options may reside on the Flight Stream page or on a dedicated setup page. Pairing occurs only when the Bluetooth Setup menu is opened.



Bluetooth Setup information includes:

- Current Bluetooth device name
- MAC address
- Pairing mode status

BLUETOOTH NAME

This key allows you to enter the name of the Bluetooth enabled device.

PFD only displays: Use the control knobs to enter the device name. Keypad entry is not available.

EIS only displays: The device name is set up using Garmin Pilot. Manual data entry is not required.

1.17.1 Managing Paired Devices



To view a list of all paired devices and their connection status, tap **Manage Paired Devices**.

AUTO RECONNECT

This key enables automatic connection between the GDU and the paired device when the two are within range.

REMOVE

Removing a device from the list means it is no longer paired with the GDU. This action requires pilot confirmation.

Be sure to remove pairing on both devices before attempting to pair them again.

1.18 Wi-Fi Setup



Wi-Fi setup information includes:

- Wi-Fi SSID
- Wi-Fi password
- MAC address of both Wi-Fi module and connected device (available only after launching Garmin Pilot)

1.18.1 Connecting to Wi-Fi

Enter the required SSID and password using the provided setup keys.

PFD only displays: Use control knobs for SSID and password entry. Keypad entry is not available.

1.18.2 Viewing Wi-Fi Information



Tapping **WiFi Info** opens an information page.

WI-FI INFO STATUS

Wi-Fi connection status annunciates on the key label when this page is not active.



Flight Stream 510 requires power up.

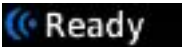

Wi-Fi is active, but the GDU is waiting to connect with a paired device.



System detects a connection between the GDU and a paired device.

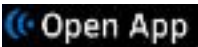

Flight Stream 510 requires Garmin Pilot to be opened in order for database transfer to commence.



This page is accessible from the Database Update and start-up pages. Information includes:

- Database Concierge connection status
- Connected device name
- Database update availability and instructions
- Wi-Fi SSID and password

Pilot Settings

1.19 Display Brightness Control

Turboprop Aircraft

Depending on installation, display brightness control may transition between lighting bus and photocell during engine start.

When you engage the start switch, display brightness control switches to photocell. When you disengage the switch, or after 60 seconds, brightness control returns to the dimmer bus.

Depending on configuration, display brightness is controlled using inputs from the built in photocell, aircraft dimmer bus, or both. Installer configured curves determine the amount of change in brightness that occurs in response to a control adjustment

If brightness control is not satisfactory, contact a Garmin dealer to adjust the lighting curves.

1.19.1 Automatic Brightness Control

Dimming is limited to prevent on screen indications from becoming unreadable. The built in photocell automatically controls display brightness based on ambient light levels.

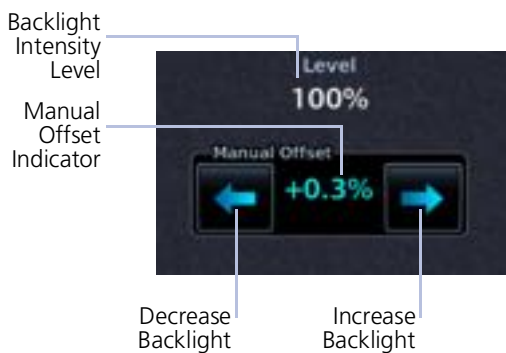

During automatic control, the pilot may still adjust brightness using the manual offset controls in the System Backlight page.

The GDU retains manual offset settings over power cycles.

1.19.2 Manual Brightness Control

Optionally, the TXi system is configurable to use an aircraft dimming bus for display brightness control. Upon reaching minimum input level, display brightness reverts to the photocell. This prevents the display from going black in the event of a dimmer input failure.

1.20 System Status Page

The System Status page displays information specific to the GDU and its databases. Refer to this page when contacting customer service. Information includes:

- Serial number
- System ID
- Main software version
- Database information

VIEW COPYRIGHTS



Tapping this key displays copyright information for all installed databases.

1.21 Click Volume

If the GDU is wired for audio output, set the click volume to the preferred level.

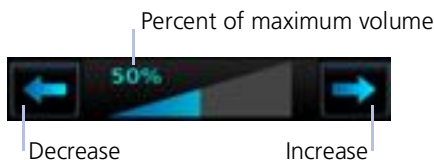

Volume displays as a percentage of the maximum volume, with 0% being muted and 100% being maximum volume.

1.22 Clock

Specify the time format and local offset. If a 12 hour or 24 hour clock is selected, tap **Local Offset**, and specify the appropriate offset value from UTC. Options include 12 hour, 24 hour, and UTC.

1.23 Weather Display Shortcut

A knob shortcut option is available when there are two or more active weather sources. Select a weather service and verify shortcut operation. Depending on configuration, available shortcut options may include:

- Connex Weather
- FIS-B Weather
- Radar
- SiriusXM Weather
- Stormscope

Weather
Radar
Shortcut

Selecting **Radar** changes the weather shortcut indicator to reflect the weather radar option is active.

1.24 Unit Selections



NOTE

Engine gauge, airspeed, and altimeter units are not pilot selectable. Interfaced equipment may contain unit settings independent of the TXi system.

The System Units page displays a list of TXi system wide unit settings. Selections are synchronized across all configured GDUs.

SPECIFY UNIT TYPE

1. Review the current unit selections.
2. Tap the applicable parameter key.
3. Select a unit type.

DISPLAY	SETTINGS
PFD	<ul style="list-style-type: none"> • BARO Pressure • Distance • NAV Angle • Temperature • Wind Speed
MFD	<ul style="list-style-type: none"> • Altitude • Distance • NAV Angle • Temperature
EIS [1]	<ul style="list-style-type: none"> • Distance • Fuel Computer [2] • Temperature

[1] Engine gauge units are not adjustable.

[2] These units are not synchronized with other displays.

Crew Profiles

FEATURE REQUIREMENTS

- Requires MFD for creating crew profiles, modifications, and deletions

The Manage Crew Profile option allows you to:

- Save TXi system wide and display specific settings
- Create individual profiles for aircraft operated by multiple pilots
- Transfer profiles between aircraft

1.25 Crew Profile Settings

Crew profile settings include both system wide and display specific settings. Specific display profile settings include the pilot adjustable parameters for each configured display.

SYSTEM & DISPLAY PROFILE SETTINGS		
DISPLAY	FUNCTION	SETTING
SYSTEM		<ul style="list-style-type: none"> • Units • Nearest Airport Criteria • Click volume • Chart Streaming • Recently used waypoint lists • Weather knob shortcut • Backlight manual offset • Database SYNC
PFD	Synthetic Vision	<ul style="list-style-type: none"> • All
	HSI	<ul style="list-style-type: none"> • HSI Map • Map overlays • Bearing pointers
	Setup	<ul style="list-style-type: none"> • Wind Field • Clock/Timer • Menu Timeout • CDI/VDI Preview • BARO SYNC • Airspeed reference bug status

SYSTEM & DISPLAY PROFILE SETTINGS		
DISPLAY	FUNCTION	SETTING
MFD	Map	<ul style="list-style-type: none"> • All
	Traffic	<ul style="list-style-type: none"> • Motion vector • Altitude filter (ABV/BLW/NRM/UNR)
	Terrain	<ul style="list-style-type: none"> • View • Layers
	Flight Plan	<ul style="list-style-type: none"> • Column data fields
	Datalink weather products (SXM, FIS-B, Connex)	<ul style="list-style-type: none"> • Map orientation • Layers • Legend on/off • FIS-B on/off • Map view configurations
	Stormscope	<ul style="list-style-type: none"> • View • Mode
	Music	<ul style="list-style-type: none"> • Preset group selection • Music category selection
	Engine	<ul style="list-style-type: none"> • EIS Lean Mode (ROP/LOP/TIT) • Engine advisories (on/off states, thresholds)
	System	<ul style="list-style-type: none"> • Time format (UTC/local) • Weather knob shortcut • Outside Air Temperature units
EIS	Engine	<ul style="list-style-type: none"> • EIS Lean Mode (ROP/LOP/TIT) [1] • Engine advisories (on/off states, thresholds)

[1] Lean mode is not applicable to turboprop installations.

1.25.1 Crew Profile Management

FEATURE LIMITATIONS

The system stores a maximum of ten profiles. This includes nine user generated profiles and one default profile. Both New Profile and Import Profile functions are unavailable when this limit is reached. It is recommended to have all GDUs online when managing crew profiles. Profile synchronization is delayed for any LRU not online at the time a profile change occurs.

Profile management functions are provided in a fly-out menu on the Manage Crew Profiles page. Available options are based on current profile selection.

Setting modifications are automatically stored within the active crew profile. If no user generated profile is active, all adjustments are saved to the Default profile. The Default option is automatically selected when no user-generated crew profile is imported or defined. New and existing profiles are listed in the Manage Crew Profiles page.

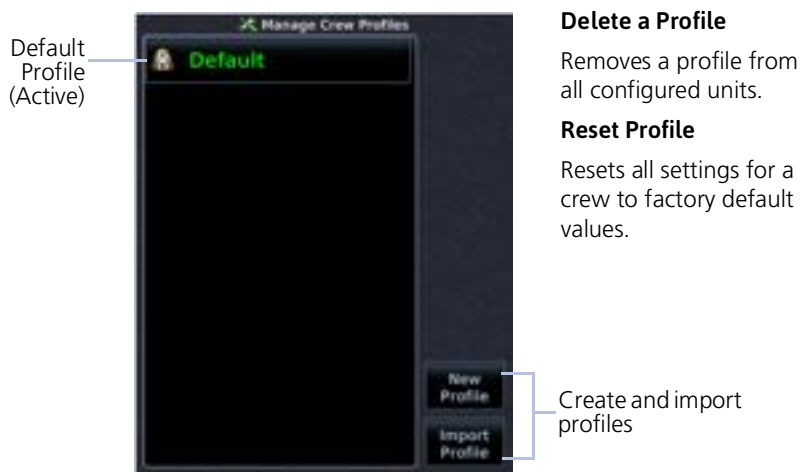

Delete a Profile

Removes a profile from all configured units.

Reset Profile

Resets all settings for a crew to factory default values.

CREATE NEW PROFILE

A profile name is required to complete operation.

1. Tap **New Profile**, enter desired profile name.
2. Tapping **Create and Activate** activates new profile and adds it to list.



ADD CREW PROFILE TO A FULL PROFILE LIST

1. Delete an existing entry from the profile list.
2. Create or import the new profile.

IMPORT A PROFILE

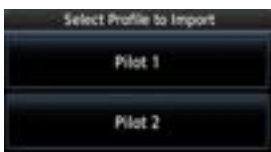

1. Insert an SD card containing a new profile.
2. Tap **Import Profile**.
3. Select profile to import.

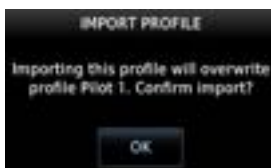

If an imported profile has the same name as the existing entry, it is possible to overwrite the existing entry or cancel request.



If imported profile has the same name as the active profile, overwrite option is not given. Acknowledge message, then activate a different profile and try again.



If SD card does not contain importable profiles, acknowledge message and replace SD card.

EXPORT A PROFILE

Export function writes a selected profile onto an SD card. This function overwrites any profile on the SD card with the same name. Available options are based on current profile selection.

ACTIVATE A PROFILE

Select a profile from list and tap **Activate**. When a profile is active:

- Name of profile turns green (active)
- All inactive profiles display in white text
- Name of active profile appears in Crew Profiles window on Setup page

System Messages

1.26 Alerts Types

The unit generates messages in response to various conditions that may occur. These abbreviated messages include:

- Warnings
- Cautions
- Function and mode advisories

1.26.1 Warnings & Cautions

Warnings require immediate attention. A caution indicates the presence of an abnormal condition that may require pilot action. A warning may follow a caution if no attempt is made to correct the condition (e.g., altering the aircraft's path to avoid the alerted terrain or obstacle).

1.26.2 System & Function Advisories



Advisories provide status and operating information.

System advisories display on a dedicated page or slide over window. Depending on the number of advisories, this list may be scrollable.

Function or mode specific advisories appear as unobstructed annunciations on the associated display.

— System Advisory Window

— Mode Advisory Annunciation

1.26.3 Alert Annunciations

Alert annunciations are abbreviated messages that indicate an alerted function or mode. The color of the annunciation depends on the alert type.

ALERT COLORS
WARNING
CAUTION
ADVISORY

- Warnings display in white text on red background
- Cautions display in black text on amber background
- Function or mode specific advisories display in black text on white background

When an alert is triggered, the annunciation flashes by alternating text and background colors. It turns solid after five seconds. All annunciations remain active (solid) until the condition is resolved or no longer a threat.

GDU 700(): Engine annunciations flash indefinitely unless acknowledged by the pilot.

ANNUNCIATION LOCATION

The location of the annunciation varies according to display and function. On the PFD, alerts annunciate to the right of the HSI. On the MFD, they annunciate in the lower right corner of the page. PFD alerts show on all configured PFD units in the TXi system.

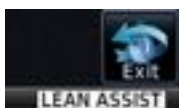
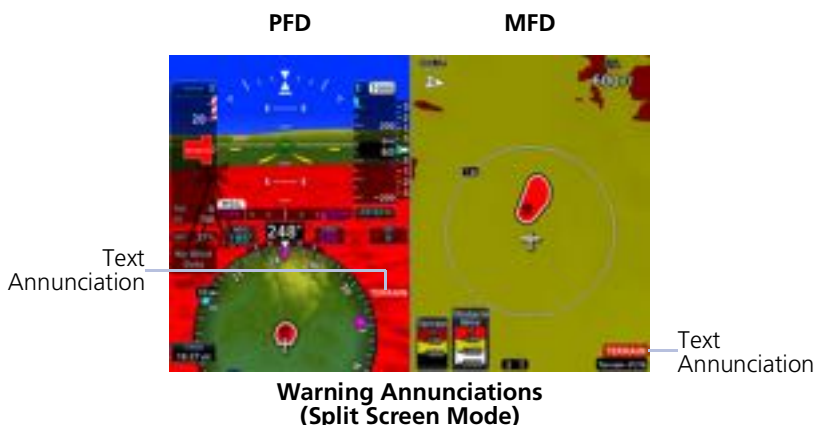

Informational advisories pertaining to EIS modes and functions appear in the annunciator bar along the bottom of the screen.

1.26.4 Pop-up Alerts

If a warning or caution relating to terrain, traffic, or the backup battery occurs, a pop-up window may display over the MFD. These pop-ups only appear if the alerted function's associated MFD page is not active.



Pop-up Alert, GDU 1060

GDU 1060: If the PFD is in full screen mode during an alert, a flashing page access key (**Terrain** or **Traffic**) replaces the **MFD** key.



Warning Indications (Full Screen Mode)

Pop-up Alert Priority

In the event of simultaneous alerts, pop-up windows display in the following order:

1. Terrain alerts
2. Traffic alerts
3. Battery alerts

Each pop-up alert contains:

- Enlarged view of the alerted threat location
- Alert annunciation
- Alert inhibit information, if applicable
- Control key for closing the pop-up window
- Direct access key to associated MFD page

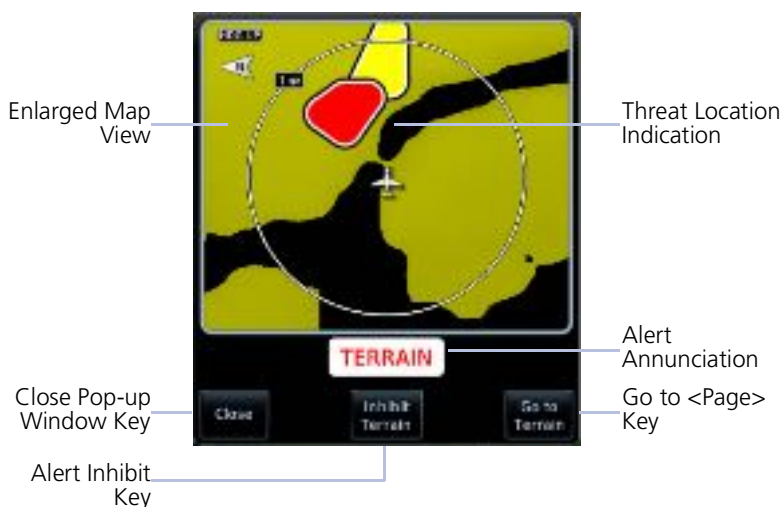

To open the indicated MFD page, tap **Go to <Page>**.

To acknowledge the alert and return to previous page view, tap **Close**.

For information about the terrain alert inhibit function, read *Alert Inhibit, TAWS and Terrain-FLTA* in section 7.

BATTERY POP-UP ALERTS



GDU 700P/1060

These pop-ups alert to backup battery status. Available options are dependent on unit and alert type.

Tapping **OK** acknowledges the alert and closes the pop-up.

GDU 700P/1060: The **View Battery Status** key provides direct access to the External LRU page.

System – External LRUs			
LRU			Status
Battery	Charge:	75%	
	Temperature:	20°C	

Battery charge and temperature status display at the top of the LRU list.

GDU 700L: On PFD, battery pop-up alerts display in one of two locations depending on the state of the battery and the aircraft.



Vertical Pop-up Alert

Cautions display vertically along the left side of the screen.

These alerts may occur in flight. They do not display when the PFD menu is open.



Horizontal Pop-up Alert

Loss of aircraft power alerts display horizontally in front of the HSI.

This alert occurs only on ground. It displays whether or not the menu is open.

1.26.5 Aural Alerts

Some alerts are accompanied by an aural voice message. Voice gender is configured during installation. To determine which alerts provide aural indications, refer to the applicable alerts table.

1.27 Advisories

Advisories are system-related messages that display across all connected GDUs in the TXi system. The alert includes the ID relative to the display.

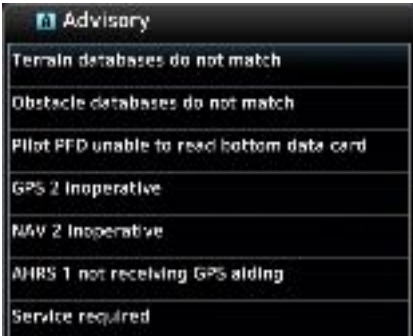

- Most recent advisories are at the top of list
- View-once advisories remain in queue until viewed by the pilot
- Persistent (or conditional) advisories remain active until the indicated condition is resolved
- Acknowledging an advisory on one GDU automatically acknowledges the message across all TXi units

All advisories are logged in the unit's internal storage. This log may be viewed in configuration mode and exported to an SD card.

ADVISORY KEY



Tapping the **Advisory** key once displays the advisory list. Tapping it again acknowledges all active advisories and closes the list.

- Flashes in navigation bar when a new advisory is present
- Turns solid once all active advisories are acknowledged
- No longer displays after all active advisories are cleared

1.27.1 Audio Advisories

Contact the dealer for all audio related issues.

ADVISORY	CONDITION
Audio inoperative.	A failure occurred with audio device.
	An audio clip does not play.
	Communication with audio device is lost.

1.27.2 Battery Advisories

ADVISORY	CONDITION	CORRECTIVE ACTION
<GDU> battery unavailable: capacity test required.	Battery capacity test failure.	Service required. Acknowledge pop-up alert. Contact dealer for support.
	Annual capacity test overdue.	Testing required. Acknowledge pop-up alert. Contact dealer for support.
<GDU> battery unavailable: communication lost.	Battery communication is lost.	Service required. Acknowledge pop-up alert. Contact dealer for support.
<GDU> battery unavailable: fault detected.	A battery fault is present.	Service required. Acknowledge pop-up alert. Contact dealer for support.
<GDU> battery unavailable: power output failed.	Battery power output failure.	Service required. Acknowledge pop-up alert. Contact dealer for support.
<GDU> on battery power for <MM:SS>.	The indicated GDU is operating in battery mode.	Ensure that the aircraft is in a safe state. Correct the issue to restore electrical power to the GDU.

1.27.3 Database Advisories

ADVISORY	CONDITION	CORRECTIVE ACTION
AHRS 1/2 magnetic model database needs update.	AHRS 1/2 magnetic field model database is out of date. Occurs only when the aircraft is on ground.	Update IGRF database according to instructions in the "Databases" section.
<GDU> <Navigation/ SafeTaxi/Obstacle> database expires on <date>.	The indicated database is approaching expiration (PFD-only displays).	If available, load the next cycle of database into standby.
	The indicated database is expired (PFD-only displays).	Update indicated database, if necessary.
<GDU> <Navigation/ Terrain/Obstacle> database unavailable.	The indicated database is unavailable or corrupt.	Re-download and install the indicated database on the GDU. Contact a Garmin dealer for support.
<Navigation/ Terrain /Obstacle> databases do not match.	Two or more TXi GDUs have a different version of the indicated database.	Update the indicated database. For information about all installed databases, go to the System Status page.
<GDU> <SafeTaxi/ Basemap> database unavailable.	The indicated database is corrupt (PFD-only displays).	Re-download and install the indicated database, Contact a Garmin dealer for support.
	The indicated database is unavailable (PFD-only displays).	
Chart database expires on <date>.	The charts database is approaching expiration.	If available, load the next cycle of the charts database into standby.
	The charts database is expired Appears only on units with an MFD.	Update the database if necessary for operation.
<GDU> Chart database incomplete. Some charts unavailable.	Charts database verification failure.	Re-download and install the indicated database. Contact a Garmin dealer for support.
Chart database unavailable.	The configured charts database is unavailable (MFD displays).	Re-download and install the indicated database, Contact a Garmin dealer for support.

ADVISORY	CONDITION	CORRECTIVE ACTION
Chart streaming unavailable. Using installed chart database.	Chart streaming is not available. The GDU reverted to the currently installed charts.	Open the System Status page and check database synchronization status. If the problem persists, contact a Garmin dealer for support.
Database SYNC in progress. View System Status page for more info.	Database synchronization is in progress.	Wait for database synchronization to complete. Restart the GDU before attempting to use new databases.

1.27.4 Emergency Descent Mode Advisories

ADVISORY	CONDITION	CORRECTIVE ACTION
Emergency Descent Mode ACTIVATE switch inoperative.	EDM switch inoperative.	Contact a Garmin dealer for service.
Emergency Descent Mode automatic activation unavailable. Service required.	EDM cabin pressurization is enabled on GDU, but GMC 605 is not providing cabin pressure altitude.	
Emergency Descent Mode unavailable. Service required.	EDM is enabled on GDU, but not supported by GMC 605.	
Emergency Descent Mode automatic activation is inhibited.	Auto EDM toggle key in the PFD Setup menu is off.	Enable the Auto EDM function. On PFD: Tap Menu > Auto EDM .

1.27.5 Engine System Advisories

ADVISORY	CONDITION	CORRECTIVE ACTION
<High/Low> <gauge name> advisory (e.g., High Oil Temperature, Low Battery Voltage).	The indicated engine parameter exceeds pilot-specified value.	Verify that parameter is within the operating limitations defined in the POH.
EGT Difference advisory. [1]	Pilot-specified EGT Diff is exceeded by one or more engines.	
CHT Cooling advisory. [1]	A cylinder's cooling rate is faster than pilot-specified CHT cooling rate.	
Low EST Fuel Remaining advisory.	Estimated fuel on board is below pilot-specified limit.	
Low Endurance advisory.	Remaining flight endurance is below pilot-specified limit.	
Automatic Ignition unavailable [2]	System is unable to activate automatic ignition (In-flight only).	Monitor engine status and environmental conditions and activate igniters manually in accordance with the POH. Contact dealer for service.
Service required [2]	System is unable to activate automatic ignition (On-ground only).	Contact dealer for service.

[1] Piston installations only.

[2] Turbine installations with automatic ignition enabled.

1.27.6 Terrain Advisories

ADVISORY	CONDITION	CORRECTIVE ACTION
Service TAWS. Invalid config.	Terrain/TAWS alerting configuration is invalid.	Contact a Garmin dealer for support.
	Fixed-Wing/Rotorcraft mismatch. The GDU's aircraft setting conflicts with the current external TAWS configuration.	
SVT could not be enabled.	The SVT feature cannot be unlocked with the current SD card.	Verify that the SVT feature unlock card is inserted in the GDU. If necessary, contact a Garmin dealer for support.
SVT has been successfully enabled. Restart all GDUs to complete enablement.	The SVT feature is enabled during the current power cycle.	To complete feature enablement, restart all configured GDUs.
<GDU> terrain database resolution insufficient.	Terrain database resolution does not support the current terrain alerting configuration (rotorcraft only).	Download and install the 2.9 arc-second Terrain database.
SVT Disabled	Outside terrain database coverage area.	Contact a Garmin dealer for database options.
Terrain/SVT Free Trial Flight time remaining: XX HRS	Terrain Settings Menu displays the flight hours remaining in the SVT free trial period.	<p>If SVT is desired, do one of the following:</p> <ul style="list-style-type: none"> • Contact a Garmin dealer to complete feature enablement within the 11 hour free trial period • Visit flyGarmin.com and purchase the feature enablement

1.27.7 Traffic System Advisories

The following advisories pertain to various traffic system failures.

ADVISORY	CONDITION	CORRECTIVE ACTION
1090ES traffic receiver fault.	ADS-B LRU reports that it is unable to receive 1090 Extended Squitter traffic.	Service required. Contact dealer for support.
ADS traffic alerting function inoperative.	The ADS-B LRU reports a traffic alerting failure.	Service required. Contact dealer for support.
ADS traffic function inoperative.	The ADS-B LRU reports a failure with the ADS-B Traffic input.	Service required. Contact dealer for support.
TAS/TCAS function inoperative.	TAS/TCAS device reports a traffic failure.	Reset the TCAS device. Contact dealer for support.
	Communication with the TAS/TCAS device is lost.	
TAS/TCAS system in standby.	The TAS/TCAS device is in standby mode for longer than 60 seconds while airborne.	If traffic alerts are desired, enable the operating mode of the traffic device.
Traffic/FIS-B functions inoperative.	The ADS-B LRU reports a critical fault and is inoperative.	Service required. Contact dealer for support.
	Communication with the ADS-B LRU is lost.	Service required. Contact dealer for support.
UAT fault.	The UAT LRU reports a low battery or fan fault.	Service required. Contact dealer for support.
UAT traffic/data receiver fault.	The ADS-B LRU reports that it is unable to receive UAT traffic and FIS-B data.	Service required. Contact dealer for service.
TCAS RA display unavailable on VSI. Expand <GDU> to full screen mode to restore. [1]	The GDU is operating in display backup mode, and the current VSI format is not able to display RAs.	Change the VSI type by expanding the PFD using the FULL key.

[1] TCAS II equipped aircraft only.

1.27.8 Satellite Service Advisories

The following advisories pertain to various satellite service conditions and failures. For support regarding all satellite service advisories, contact a Garmin dealer.

ADVISORY	CONDITION
Connex weather receiver inoperative.	Communication with the GSR 56 is lost. The satellite weather service is in operative.
Connex weather service not registered.	GSR 56 weather service requires registration for operation.
SiriusXM receiver inoperative.	SiriusXM receiver failure.
	Communication with the GDL 69/69A is lost.

1.27.9 PFD Advisories

The following advisories pertain to various conditions and devices associated with the PFD.

ADVISORY	CONDITION	CORRECTIVE ACTION
ADC 1/2 error correction inoperative.	The indicated ADC reports that airspeed error correction is unavailable.	Contact dealer for service.
	The indicated ADC reports that altitude error correction (i.e., SSEC) is unavailable.	
<GDU> ADS-B in traffic does not match configuration.	The primary ADS-B traffic source is not available. GDU is relying on data from backup source.	Contact a Garmin dealer for support.
AHRS 1/2 not receiving GPS aiding.	The indicated AHRS is not receiving GPS data from any source.	Ensure that the navigator(s) is on and receiving a GPS signal. Check the AFMS for limitations. Contact dealer for service.
<GDU> air data input failure. V_{NE} is uncorrected.	The indicated GDU is not receiving temperature or pressure altitude data. Applicable to rotorcraft only.	Refer to airspeed limitations placard for applicable V_{NE} .

ADVISORY	CONDITION	CORRECTIVE ACTION
<GDU> demo mode, do not use in flight.	The unit is in demonstration mode.	To exit demo mode: Cycle power to the GDU. If the problem persists, contact dealer for service. Operating the GDU in demo mode during flight is prohibited.
GPS 1/2 inoperative.	The indicated GPS source failed.	Ensure that the navigator(s) is on and receiving a GPS signal.
	Communication with the indicated GPS is lost.	Switch to an alternate navigation source. Contact dealer for service.
NAV 1/2 inoperative.	The indicated NAV source is failed, or input data is not received.	Switch to an alternate navigation source.
<LRU> reports service required.	The indicated LRU reports an internal fault and requires service. Appears only when the aircraft is on ground.	Contact dealer for service.
Reset altitude preselector to enable VPATH descent.	TOD ahead. Vertical deviation is available and the selected altitude is < 75 ft below current altitude. Appears only for aircraft equipped with GFC 600.	Lower the selected altitude to at least 75 ft below the current aircraft altitude.
<GDU> backlight calibration lost.	The GDU cannot read LED calibration data, or the data is corrupt. Sunlight readability may be degraded. Appears only when the aircraft is on ground.	Contact dealer for service.
<GDU> controller unavailable.	Communication with GCU 485 is lost. Appears only when the aircraft is on ground.	Operate the indicated GDU using the touchscreen controls.

System Description

ADVISORY	CONDITION	CORRECTIVE ACTION
Service required.	The system or unit requires service. Appears only when the aircraft is on ground.	Contact dealer for service.
Service soon.	The system or unit detects an internal fault but continues to function. Appears only when the aircraft is on ground.	Contact dealer for service.

1.27.10 System Hardware Advisories

ADVISORY	CONDITION	CORRECTIVE ACTION
<GDU> controller <ALT ARM/GPSS/CDI/VS ENG> key stuck.	The indicated key is stuck on GCU 485.	Push the indicated key again. If the key remains stuck, use the corresponding touchscreen controls. Contact dealer for service.
<GDU> controller <HDG/BARO/VS> knob-push stuck.	The indicated knob is stuck on GCU 485.	Push the indicated knob again. If the knob remains stuck, use the corresponding touchscreen controls. Contact dealer for service.
<GDU> controller has multiple stuck controls.	The unit detects multiple stuck controls on the GCU 485.	Use the touchscreen controls for all manual operations. Contact dealer for service.
<GDU> cooling fan failed.	The indicated GDU detects a cooling fan fault. PFD/MFD coloration may be incorrect. The backlight may dim to reduce power and heat.	Extended operation at high temperatures is not recommended as damage to the unit may occur. Contact dealer for service.
<GDU> display hot, display dimmed.	Unit temperature exceeds the over temperature threshold.	Decrease cabin temperature and increase cabin airflow near the GDU. If the problem persists, contact the dealer for service.
<GDU> <left/right/both> knob-push stuck.	The indicated GDU knob(s) is stuck.	Use the touchscreen controls for all manual operations.
Electronic Stability Protection failed.	Garmin Mode Controller signals an ESP system fault.	Consult the pilot's guide for the Garmin Mode Controller.

ADVISORY	CONDITION	CORRECTIVE ACTION
<GDU> unable to read <top/bottom/left/right> datacard.	The SD card in the indicated slot is unreadable or corrupt (i.e., data is unavailable).	Reformat the SD card using an external computer. Re-insert the SD card in the slot. If the problem persists, contact the dealer for service.
	The SD card is missing from the indicated slot.	Re-insert the SD card in the slot.
	User ejects Flight Stream 510 wireless datacard. Network connection lost.	Restart GDU to reconnect.

1.27.11 Weather Service Advisories

ADVISORY	CONDITION	CORRECTIVE ACTION
Possible severe weather ahead. Check Weather Radar.	Weather alert detected within +/- 10 degrees of the aircraft heading. This advisory does not appear when the Weather Radar page is active on any TXi unit.	To view information about severe weather in the current flight path, open the Weather Radar page.
Stormscope inoperative.	The GDU is not receiving data from the Stormscope unit.	Consult the appropriate third-party documentation.
	Stormscope reports a failure status.	
Weather radar needs service.	Weather radar reports a degraded or inoperative condition exists. Appears only when the aircraft is on ground.	Contact dealer for service.
Weather radar inoperative.	The unit is not receiving weather radar data.	Contact dealer for service.

1.28 LRU Failure Annunciations

LRU fail annunciations are designed to be immediately recognizable. If an LRU failure occurs, a red or amber “X” appears over the associated flight instrument(s) or data field(s). For additional information regarding pilot responses to LRU failures, consult the AFMS.

The annunciation color is determined by instrument type.

- Red “X” displays over primary flight instruments and data fields
- Amber “X” displays over non-primary flight instruments

1.28.1 PFD Failure Annunciations

During power-up, certain flight instruments are invalid until the associated equipment completes initialization. Data fields (e.g., TAS, GS, SAT) display only dashes when the input source is not available.



If an instrument remains flagged after one minute, check the status of the associated LRU, then contact a Garmin dealer for additional support. For Garmin LRUs, go to the External LRUs page and note any failed LRUs.

INDICATOR	ANNUNCIATION AND CONDITION
Airspeed	Annunciation: Red “X” Condition: Display is not receiving airspeed data from ADC.
Altitude	Annunciation: Red “X” Condition: Display is not receiving altitude data from ADC.
Attitude	Annunciation: Red “X” Condition: Display is not receiving attitude and heading information from the AHRS.
Vertical Speed	Annunciation: Amber “X” Condition: Display is not receiving vertical speed data from ADC.
HDG FAIL	Annunciation: Red rectangle with white text “HDG FAIL” Condition: AHRS indicates that the magnetic heading value is invalid.

1.28.2 EIS Failure Annunciations

An LRU failure annunciates on the EIS when instrument sensory data become invalid or unavailable.

Gauge values do not display when the gauge is inactive.

Sensor Data Invalid or Unavailable

In addition to an amber "X," voltage meters and fuel management instruments display a message if the associated sensor requires configuration or calibration.

Not Configured

Not Calibrated

EIS Gauge Strip

1.29 GDU Failure Annunciations

1.29.1 Fan Failure Annunciation, GDU 700()

ANNUNCIATION	ALERT TYPE & CONDITION
FAN FAIL	Alert Type: Caution
	Condition
	GDU internal cooling fan failure for >10 seconds.

1.30 ADS-B Status

FEATURE REQUIREMENTS

- Universal Access Transceiver (GDL 88, GNX 375, GTX 345)

View last uplink time and GPS source information from the ADS-B Status page. You may access this page one of two ways.

From the Home page:

1. Tap **System** > **External LRUs**.
2. Scroll to the UAT device.
3. Select **More Info**.

From the Weather page:

Tap **FIS-B Weather** > **Menu** > **Datalink Status**.

UPLINK TIME

TEXT COLOR	MINUTES SINCE LAST UPLINK
Green	< 5
Yellow	5 to 15
	> 15

This field displays the number of minutes since last uplink. Digital values may change color depending on duration.

"> 15" displays when the time exceeds 15 minutes.

Dashes indicate when valid uplink data is unavailable (e.g., the device is offline).

FIS-B WEATHER

View the status of FIS-B weather products. For additional details, tap the appropriate key.

Raw Text Reports



View raw textual data for a FIS-B product.

Radio Stations

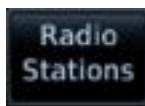

Monitor FIS-B ground station transmission status and reception completeness for certain FIS-B products.

TRAFFIC APPLICATION STATUS

View the status of all three traffic applications: • AIRB • SURF • ATAS (airborne alerts)

ANNUNCIATION	DESCRIPTION
On	Application is running. Required ownship data is available and meets the performance criteria.
Available to Run	Application is configured. Required input data is available and meets the performance criteria.
Unavailable to Run	Required input data is not available due to a failure (e.g., aircraft surveillance application process failed).
Unavailable - Fault	Required input data is available, but does not meet the performance criteria or is not available due to non-computed data conditions.

Logs

1.31 Flight Data Logging



The data logging function is capable of storing approximately 100 hours of flight data in the unit's internal memory. This information is available for export to an SD card for later analysis.

FEATURE REQUIREMENTS

- SD card for external data logging
- Flight Stream 510 wireless datacard for data streaming

FEATURE LIMITATIONS

- Engine exceedance logs are available only for turbine aircraft
- External data logging stops when the SD card is full.

Data Logging Function

- Generates log files automatically upon unit power-up
- Records various parameters related to aircraft flight instruments, engine indications, and configuration
- Streams logged flight and engine data to Garmin Pilot when Flight Stream 510 is present
- Writes logged data to an SD card if one is present in the top/left slot
- Overwrites oldest files when the internal log reaches capacity
- Saves files in the .csv format and stores them in the "data_log" folder

FILE NAMING CONVENTIONS

Log file names provide a useful reference to aid data analysis. They include:

- Log start date and time
- Identifier of the nearest waypoint at the indicated start time

log_YYMMDD_HHMMSS_WPT.csv



Files with the name "log_000101_0000XX____.csv" do not contain a valid date and time stamp. These logs may include data recorded during installation.

Data Logging at a Glance



Upon power up, the GDU...

- Begins logging flight and engine data automatically
- Stores the data in its internal memory
- Writes the data to an SD card (if present in top/left slot)[‡]

If Flight Stream is present in GTN

- GDU transfers logs to GTN, which then streams the data to Garmin Pilot
- GTN is the preferred location for Flight Stream installation

[†] Pilot setup required. [‡] No action required.

What happens if there's a power interruption?

Data logging stops if power is lost. All data recorded up to that point remains stored in the internal memory. Data is not recorded for the duration of the outage. When GDU reboots, logging automatically resumes with a new log file.

In a multi-GDU system, we recommend placing an SD card in each GDU to provide continuous data logging in the event of a GDU outage.

1.31.1 Exporting to SD Card



NOTE

Do not eject the SD card while the export function is in progress. Wait until the **Export Data Log** key is available before ejecting the card.

Home

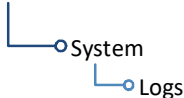

Exportable parameters are dependent on aircraft type.

1. Insert an SD card into top/left slot.
2. Power on GDU.
3. Go to the Logs page.
4. Tap **Export Data Log**.

Exporting Logs: 89%

Export in Progress

During export, the **Export Data Log** key is unavailable (gray), and displays the export progress percentage. It becomes available once export is complete.

What if I forget to insert my SD card before flight?

Internal flight and engine data logging occurs regardless of whether an SD card is present. After your flight, you may insert a card and download log files using the **Export Data Log** command.

With the aircraft safely on ground:

1. Power off unit.
2. Insert card.
3. Power on unit.
4. Tap **System** > **Logs** > **Export Data Log**.

Wait for the export to complete before ejecting the SD card.

Once the files are exported onto SD card, you may transfer the log files to your personal logbook on flyGarmin.com.

Duration varies depending on the number of files present. For lengthy transfers, it may be necessary to run the engine or operate on ground power until the export is complete.

TRANSFER DATA FROM SD CARD TO YOUR ONLINE LOGBOOK

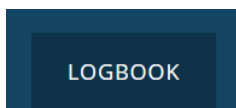

The Logbook tab provides functions for creating and viewing multiple logbook entries.

To create a logbook and upload data:

1. Sign in to your flyGarmin.com account.
2. Select **Logbook > Setup**.
3. Select **Add Aircraft Type**.
4. Provide all necessary aircraft type details, then select **Save Aircraft Type**.
5. Provide all necessary settings and pilot information, then select **Save Settings**.
6. Select **Import from Spreadsheet**.
7. Download the provided spreadsheet templates in the appropriate format. Log entries and aircraft type data each require a dedicated spreadsheet.
8. Transfer your data from the SD card to the spreadsheets.
9. Save each spreadsheet in the .csv format.
10. Upload each .csv file using the associated **Import** command.

To upload flight logs to an existing logbook entry:

1. Select **Logbook > Entries > Upload Flight Logs**.
2. Select and upload the log files according to the on-screen instructions.

1.32 Exceedance Logging



Unlike flight data logging, which records parameters at a specific rate, exceedance logs record information about a specific gauge when its value exceeds a threshold.

FEATURE REQUIREMENTS

- Turboprop EIS enablement

OR

- Fixed wing aircraft with variable V_{NE}

FEATURE LIMITATIONS

- Engine exceedances apply to turboprop aircraft only
- Exceedance viewer can acknowledge entries on only one GDU at a time

Not all gauges have exceedance logging. Availability varies depending on airframe and engine.

Exceedance Recording Function

- Generates an exceedance file after a gauge parameter exceeds its maximum allowable time at an elevated level
- Engine exceedances record in-depth data about the exceeded gauge, and contextual details about other parameters during that time
- Advisories notify 30 seconds after the exceedance ends (during flight), and once the aircraft is on ground
- Entries are available for viewing on the dedicated summary page

Exceedances are installer configured to match the aircraft limitations in the POH. Pilots are responsible for knowing and respecting all aircraft and engine limitations.

Exceedance Gauges

- Torque
- Prop RPM
- NG/N1
- Turbine Engine Temperature
- Oil Temperature
- Oil Pressure
- Fuel Pressure

Many engine gauges have a maximum allowable time limit that the parameter may operate at an elevated level. This "grace period" is indicated on the gauge's associated countdown timer. Log entries do not generate until after this timer expires.

The duration of the exceedance is the amount of time that the indicated parameter exceeds the limit, which includes the grace period time.



Each log entry includes the parameter name, and the date, time, and duration of the exceedance.

Date	Gauge	Exceed	Action
06-FEB-19 18:56 UTC	ITT	27.0 sec	ACK Alert
06-FEB-19 19:57 UTC	ITT	27.0 sec	ACK Alert
06-FEB-19 19:58 UTC	TRQ	17.0 sec	UNACK Alert
06-FEB-19 19:58 UTC	MP	14.0 sec	UNACK Alert
06-FEB-19 19:58 UTC	MG	13.0 sec	ACK Alert
06-FEB-19 19:58 UTC	TRQ	15.0 sec	ACK Alert
06-FEB-19 19:58 UTC	MG	27.0 sec	ACK Alert
06-FEB-19 19:58 UTC	TRQ	14.0 sec	ACK Alert

Exceedances Summary Page

INCOMPLETE ENTRIES



If GDU loses power while recording an exceedance, the system marks the duration as “Unknown.”

Incomplete log files contain data recorded up until the time of the interruption. Some fields are not available due to the GDU not having knowledge of parameters at the end of the exceedance.

1.32.1 Exceedance Alerts

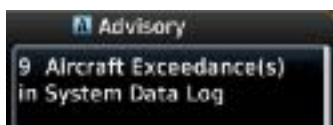

An advisory informs that an exceedance alert is available for viewing in the data log. These alerts occur 30 seconds after the exceedance ends and upon landing. Notifications persist until all exceedances are acknowledged.

ACK Alert

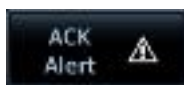

Tapping this key acknowledges the corresponding alert. An alert symbol indicates the advisory condition requires attention.

UNACK Alert

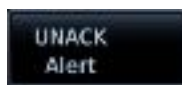

Tapping this key unacknowledges the corresponding alert. Unacknowledged entries rise to the top of the summary page.

ACKNOWLEDGE AN EXCEEDANCE ALERT

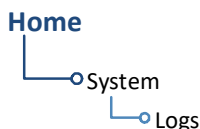

To view and acknowledge the exceedance advisory:

1. Go to the Logs page.
2. Tap **Exceedances**.
3. Review the list of alert entries.
4. Tap **ACK** for each unacknowledged entry.

1.32.2 Exceedance Details

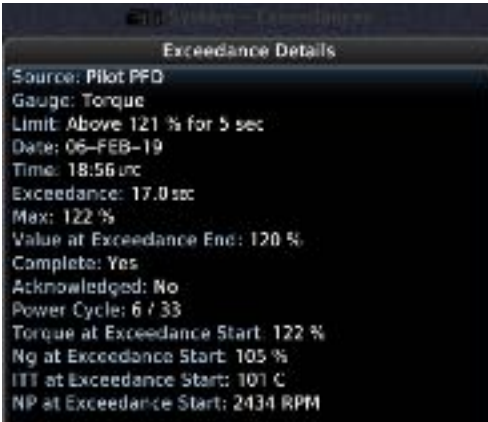

Select an exceedance file to view gauge details.

Duration and highest value are useful for determining whether maintenance actions are required.

The provided values of other engine parameters may be useful when determining if an exceedance resulted from sensor testing or failure.

Exceedance Log Data

- Gauge and exceeded parameter
- Date & time of occurrence
- Duration (total amount of time the parameter exceeded the limit, which includes the grace period time)
- Highest gauge value
- Power cycle
- Max parameter value during exceedance period
- Parameter value at end of exceedance
- Value of other engine parameters at beginning of exceedance
- Any interruptions (e.g., power loss)
- Completeness of data
- Alert state (i.e., acknowledged or unacknowledged)

The GDU uses an internal circular log to store exceedance entries for 100 power cycles that have had an exceedance. The user should periodically export the exceedance log to SD card.

If date and time parameters are not available (e.g., during engine start when the navigator has yet to acquire a GPS signal), use the power cycle parameter value to narrow down the time of occurrence.

1.32.3 Exporting to SD Card

Exportable parameters are dependent on aircraft type.

1. Insert an SD card into top/left slot.
2. Power on GDU.
3. Go to the Logs page.
4. Tap **Export Data Log**.

Compatible Equipment

1.33 Line Replaceable Units

SYSTEM REQUIRED LRUs (PFD)

ADAHRS or ADC with AHRS
GMU 44/44B
GTP 59
Garmin GPS navigator

The TXi system consists of multiple LRUs, which are installed behind the instrument panel or in a separate avionics bay. Their modular design aids system maintenance and unit replacement.

SYSTEM OPTIONAL LRUs

Backup GPS antenna
GAD 43/43e adapter
GBB 54 battery
GCU 485 PFD controller
GEA 110 engine airframe interface [1]
GEA 71 engine airframe interface [2]

Optional LRUs may include compatible equipment from either Garmin or a third party manufacturer.

OPTIONAL INTERFACES

ADF
Airborne weather radar
Autopilot/flight director
DME
G5
GDL 69/69A SiriusXM data link
GDL 88/GTX 345 ADS-B transceiver
GI 275
GSR 56 satellite data link
GTX 330 or 335 mode S transponder (TIS-A)
Radar altimeter
Stormscope
TAS/TCAS/TCAS II
VHF NAV and glideslope receiver

Some LRUs provide features that require registration and/or enablement prior to activation.

[1] Piston aircraft only.
[2] Turboprop aircraft only.

1.33.1 LRU Status

Devices that interface to the system via Ethernet display product information on the System Status page. Some interfaced equipment provide controls for product registration, enablement or viewing detailed status information. For additional information, touch **More Info**.



The device is configured and communicating properly



The device is not available and is not configured or it is not communicating properly

1.33.2 Integrated Standby Instrument - Piston Aircraft

An integrated standby instrument configuration consists of two GDU 700Ps, each with separate AHRS/ADC sensors. One display serves as the PFD, the other as EIS, MFD, or MFD/EIS. When activated, the display backup switch forces both displays into their display backup mode of operation.

The GBB 54 backup battery provides power to the PFD and sensors in the event of primary aircraft power failure. Both displays monitor and compare independent attitude, altitude, and airspeed data. The EIS, MFD, or MFD/EIS automatically displays its backup primary flight information when:

1. Either display detects a miscompare between attitude, altitude, or airspeed parameters.
2. Communication between displays is lost.
3. The display backup toggle switch is active.

This configuration provides the following functionality, which satisfies the backup instrumentation requirements.

The MFD, EIS, or MFD/EIS behaves as follows:

- An MFD will transition to a full-screen PFD display
- An EIS will transition to a split-screen PFD/EIS display
- An MFD/EIS will transition to a split-screen PFD/EIS display

1.33.3 Standby Instruments

Except for installations limited to VFR, PFD installations require standby attitude, altitude, and airspeed instruments. Several types of standby instruments are acceptable, including individual analog instruments and certain electronic standby indicators.

G5 STANDBY ATTITUDE INSTRUMENT

FUNCTIONAL LIMITATIONS

- Available functionality dependent upon installation and configuration settings
- G5 standby (not part of GFC 500 system) synchronization functionality (an optional capability) requires installation of GAD 29B adapter

GFC 500	G5 FUNCTION
Present	<ul style="list-style-type: none"> • Backup autopilot control and GPS coupling • Standby attitude display
Not present	<ul style="list-style-type: none"> • Standby attitude display

G5 is an optional electronic flight instrument capable of operating as a standalone flight display or as a fully integrated standby instrument.

G5 Standby Instrument Features

- Mirrors GDU control settings for Barometric Correction and Selected Course

G5 Features when Installed with GFC 500 system

- Automatic synchronization of the following PFD controls: Selected Airspeed, Selected Altitude, Selected Heading, and Selected Vertical Speed
- Mirrors GDU control settings for Barometric Correction and Selected Course
- Displays CDI navigation source selection data received from the GDU

To initiate synchronization, set the G5 barometric pressure setting to match corresponding control setting on the GDU. Both units remain in sync until the barometric pressure setting is manually adjusted on G5.

Synchronization occurs after a short delay. The duration of this delay varies depending on which unit is attempting to sync.

CONDITION	SYNCING OCCURS...
Pilot adjusts barometric setting on G5 to match corresponding correction control setting on GDU.	After 5 seconds
Pilot adjusts barometric correction control setting on GDU to match corresponding setting on G5.	After 1 minute

GI 275 STANDBY ATTITUDE INSTRUMENT

FUNCTIONAL LIMITATIONS

- Available functionality dependent upon installation and configuration settings

FEATURE REQUIREMENTS

- GI 275 must be configured as a Full Time ADI, Standby ADI, or Standby ADI as Primary HSI

GI 275 is a multifunction indicator capable of operating as a PFD, HSI, EIS, MFD, radar altimeter display, and/or autopilot interface. When a GI 275 configured as a standby attitude instrument (ADI) detects a fault, the unit exclusively behaves as a primary attitude instrument until the fault is resolved. Alternatively, the crew can select reversionary operation modes via panel-mounted switches.

Depending on configuration, the GI 275 ADI may have functions in addition to the basic standby attitude display.

ADI CONFIGURATION	FUNCTIONS
Basic	<ul style="list-style-type: none"> • Standby attitude
3-in-1	<ul style="list-style-type: none"> • Standby attitude • Standby airspeed • Standby altitude
4-in-1	<ul style="list-style-type: none"> • Standby attitude • Standby airspeed • Standby altitude • Magnetic heading

GI 275 Standby Instrument Features

- May be configured to mirror GDU control settings for Barometric Correction and Selected Course.

1.33.4 PFD Controller

FUNCTIONAL LIMITATIONS

- Applicable to PFD only
- Selecting a data field does not automatically open control menu

An optional GCU 485 PFD controller provides dedicated PFD controls. Although control of PFD functions is available using the GDU knobs and touchscreen, the PFD controller provides dedicated knobs for heading, altitude, vertical speed, airspeed, and BARO setting. Dedicated keys are provided for CDI source selection, GPSS emulation mode, altitude capture arming, and vertical speed mode engagement. If configured, the PFD controller is used to control a Standby PFD.



GCU 485 Features

- Control knobs offer alternative ways to adjust reference bugs and barometric settings
- Push button configuration depends on the interfacing autopilot: CDI, GPSS, ARM, and ENG
- Lighting may be controlled by the aircraft lighting or the internal photocell (dependent upon configuration)

PFD CONTROLLER OPTIONS	
ALT	Sets the selected altitude bug.
HDG	Sets the selected heading bug.
BARO	Sets the selected barometric pressure value. Pushing the knob reverts the setting to standard.
IAS	Sets the selected indicated airspeed.
VS	Sets the selected vertical speed.
ARM	Arms the autopilot altitude capture function.
CDI	Changes the NAV source for the CDI.
ENG	Engages the autopilot vertical speed mode.
GPSS	Engages or disengages GPSS mode.

1.33.5 Backup Battery

An optional GBB 54 backup battery provides emergency power to a GDU display, integrated ADAHRS, and a single GEA 110. The backup battery is mounted remotely and provides power when aircraft power is unavailable. This allows for continued PFD, MFD, and EIS functionality when aircraft electrical power is lost.

LRU	DISPLAY	FUNCTION
GBB 54 Alternate emergency power source for GDU 700().	PFD	Battery availability and charge/discharge status
	MFD	
	EIS	

1.33.6 ADC & AHRS

The ADC and AHRS sense air data and aircraft attitude for display and use by other systems. AHRS units have a magnetometer interface for determining magnetic heading. ADC units have an OAT probe interface for measuring outside air temperature.

LRU	DISPLAY	FUNCTION
GDC 72 GDC 74 ADC	PFD	<ul style="list-style-type: none"> • Air temperature • Airspeed • Altitude • Vertical speed
GSU 75/75B Integrated ADAHRS	PFD	<p>ADC</p> <ul style="list-style-type: none"> • Air temperature • Airspeed • Altitude • Vertical speed <p>AHRS</p> <ul style="list-style-type: none"> • Attitude • Heading • Rate of turn • Slip/skid/yaw
GRS 77 GRS 79 AHRS	PFD	<ul style="list-style-type: none"> • Attitude • Heading • Rate of turn • Slip/skid

1.33.7 PFD Adapter

AUTOPILOT INTERFACE

LRU	DISPLAY	FUNCTION
GAD 43 Adapter	PFD	Analog attitude, heading, and yaw data for certain autopilots [1]
GAD 43e Enhanced Adapter	PFD	<ul style="list-style-type: none"> • Altitude preselect • VS control • Yaw damper • DME • NAV • ADF • RAD ALT

[1] Requires GRS 77/GRS 79/GSU 75 or internal ADAHRS.

1.33.8 Autopilot

AUTOPILOT ALTITUDE PRESELECT/VERTICAL SPEED

LRU	DISPLAY	FUNCTION
Collins: APS-65()	PFD	Selected altitude sync
Honeywell (Bendix King): KAP 100/150 KFC 150 KFC 200/250 KFC 275/325		<ul style="list-style-type: none"> • Altitude capture armed annunciation • Altitude capture engaged annunciation • Selected altitude sync • Selected VS sync [1] • VS engaged annunciation [1]
S-TEC: 55X 60-2 65 60 PSS		<ul style="list-style-type: none"> • Selected altitude sync • Selected VS sync

[1] KAP 150 and KFC 150/275/325 only.

AUTOPILOT EXTERNAL FLIGHT DIRECTOR

LRU	DISPLAY	FUNCTION
Bendix: M-4D	PFD	External flight director
Century: IV 41 2000		
Cessna: 300B IFCS/400B IFCS/800B IFCS 1000 IFCS		
Collins: APS-65 AP-106/107		
Honeywell (Bendix King): KFC 150/200/250 KFC 225/275/325 KFC 300		
S-TEC: 55 55X 60-2/65 1500/2100		
Sperry: SPZ-200/500		

FLIGHT CONTROL SYSTEM

LRU	DISPLAY	FUNCTION
Avidyne: DFC90	PFD	<ul style="list-style-type: none"> • Mode annunciations • Bug sync • Flight Director
Garmin: GFC 500 GFC 600	PFD	<ul style="list-style-type: none"> • Electronic Stability and Protection annunciations [1] [2] • Overspeed/underspeed protection annunciations [3] • Mode annunciations [4] • Bug sync [5] • Flight Director

- [1] ESP roll engagement limits display differently between autopilots.
- [2] Available only when ESP is enabled and AP is disengaged.
- [3] Available only when AP is engaged and aircraft exceeds minimum or maximum engagement speed.
- [4] Track mode annunciation available only on GFC 500.
- [5] Includes value display and control for ALT, HDG, IAS, and VS. BARO sync, CDI source selection, and Selected Course sync output to primary attitude indicator when interfaced with G5 Electronic Flight Instrument.

1.33.9 Weather & Music

LRU	DISPLAY	FUNCTION
GDL 69/69A SXM Garmin SiriusXM receiver for weather. Overlays weather products on MFD and HSI Map.	PFD.	Weather Products <ul style="list-style-type: none"> • NEXRAD • SXM Lightning • TFRs
	MFD.	Weather Products [1] Map Page: <ul style="list-style-type: none"> • NEXRAD • Cloud Tops • Echo Tops • SXM Lightning • METARs • Storm Cells • TFRs Weather Page: <ul style="list-style-type: none"> • AIREP • NEXRAD • City Forecast • Cloud Tops • County Warnings • Cyclone • Echo Tops • Winds Aloft • Surface Pressure • SXM Lightning • Storm Cells • METARs • AIRMETs • SIGMETs • TFRs • PIREPs • Freezing Levels • Turbulence Forecast • Icing Forecast
GDL 69A SXM Garmin SiriusXM receiver for entertainment.	MFD.	Entertainment Services SiriusXM Radio

LRU	DISPLAY	FUNCTION
GDL 88 GTX 345 GNX 375 Datalink traffic and weather.	PFD	Traffic Services <ul style="list-style-type: none"> • ADS-B • TIS-B Weather Services <ul style="list-style-type: none"> • FIS-B
	MFD	
GSR 56 Garmin (Iridium) Satellite Receiver for Connex weather. Overlays weather products on MFD and HSI Map.	PFD	Weather Products <ul style="list-style-type: none"> • Lightning • Precip • TFRs
	MFD	Weather Products Map Page: <ul style="list-style-type: none"> • Precip • IR Satellite • Lightning • METARs Weather Page: <ul style="list-style-type: none"> • Precip • IR Satellite • Winds Aloft • Lightning • METARs/TAFs • AIRMETs • SIGMETs • TFRs • PIREPs
WX-500 Depicts Stormscope data on MFD and HSI Map.	PFD	Lightning strikes
	MFD	

LRU	DISPLAY	FUNCTION
<p>Garmin: GWX 68 GWX 70 GWX 75 Provides airborne weather radar information. [6]</p>	MFD.	<ul style="list-style-type: none"> • Ground, standby, test, and weather modes • Horizontal and vertical profiles • Roll/trim • Stabilization • Sector scan • Altitude compensated tilt [2] [3] • High resolution color scale [3] • Tilt limit (vertical sector scan) • WATCH shading • Target alert • Range • Tilt angle • Bearing angle • Gain <p>GWX 70/75 Features [4]</p> <ul style="list-style-type: none"> • Turbulence Detection • Ground Clutter Suppression
<p>Honeywell (Bendix King) [4]: RDS 81 (RS 811A) RDS 82 (RS 181A) RDR 2000 (ART 2000) RDR 2100 (ART 2100) Third-party weather radar. [6]</p>		<ul style="list-style-type: none"> • Ground, standby, test, and weather modes • Horizontal profile • Vertical profile [5] • Roll/trim • Stabilization • Range • Tilt angle • Bearing angle [5] • Gain (ground mode)

[1] Product availability dependent upon subscription.

[2] GWX 70 only.

[3] GWX 75 only.

[4] Requires purchase of an enablement card.

[5] Feature dependent on radar.

[6] Not available on GDU 700() EIS/MFD configurations.

1.33.10 Engine Monitoring

RECIPROCATING ENGINES

LRU	DISPLAY	FUNCTION
GEA 110 Garmin Engine Adapter. Monitors engine, fuel, and electrical systems for piston engine aircraft.	EIS.	<ul style="list-style-type: none">• Manifold Pressure• RPM• Percent Power• Fuel Flow• Oil Pressure• Oil Temperature• EGT• CHT• TIT• IAT• Fuel Quantity• Volts• Amps• Engine Data• Vacuum/Pressure• Flight Control Trim Position

TURBINE ENGINES

LRU	DISPLAY	FUNCTION
GEA 71B GEA 71B Enhanced GEA 71C Garmin Engine Adapter. Monitors engine, fuel, and electrical systems for turbine aircraft.	EIS.	<ul style="list-style-type: none"> • Propeller RPM • Gas Producer RPM • Torque • Shaft Horsepower • Percent Power • Engine Temperature • Fuel Flow • Fuel Quantity • Oil Pressure • Oil Temperature • Fuel Pressure • Volts • Amps • Engine Data • Vacuum/Pressure • Flight Control Trim Position

1.33.11 Magnetometer

LRU	DISPLAY	FUNCTION
GMU 44/44B Provides magnetic information to the AHRS.	PFD.	<ul style="list-style-type: none"> • Heading • Compass

1.33.12 Navigation/FMS

LRU	DISPLAY	FUNCTION
GPS 175 GPS 400W GPS 500W GNC 355 GNC 420W GNS 430W GNS 480 GNS 530W GNX 375 GTN 625 GTN 635 GTN 650 GTN 725 GTN 750	PFD.	<ul style="list-style-type: none"> • ILS/VOR [1] • LOC [1] • GS [1]
	MFD	<ul style="list-style-type: none"> • GPS position

[1] Feature requires a NAV radio source.

1.33.13 Temperature Probe

LRU	DISPLAY	FUNCTION
GTP 59	PFD. EIS.	Outside air temperature

1.33.14 Radar Altimeter

LRU	DISPLAY	FUNCTION
Garmin: GRA 55/5500	PFD.	Radar altitude (next to altitude tape)
Collins: RAC-870 ALT-50A ALT-55B		
FreeFlight: RA-4500		
Honeywell (Bendix King): KRA 10/10A KRA 405/405B		
Sperry: AA-100 AA-100A AA-200		

1.33.15 Traffic

LRU	DISPLAY	FUNCTION
GTX 33 GTX 330 GTX 335 GTX 345	PFD MFD	TIS-A
Garmin: GTS 800 GTS 820 GTS 825 GTS 850 GTS 855	PFD	TAS/TCAS I
GTS 8000	PFD/MFD	TCAS II
Avidyne (Ryan): TAS 6XX (9900BX)	MFD	TAS/TCAS I
Honeywell (Bendix King): KTA 810 KMH 820 KTA 910 KMH 920		
L3 Communications (Goodrich): SKY497 SKY899		
GDL 88 GNX 375 GTX 345	PFD MFD	ADS-B
Third-party TCAS II	PFD/MFD	TCAS II

2 Primary Flight Display

PFD SETUP

2.1	Synchronization Options	2-5
2.2	Reference Bugs and Controls	2-6

FLIGHT INSTRUMENTS

2.3	Attitude Indicator	2-11
2.4	Extreme Attitude Indications	2-14
2.5	VNAV Guidance Indications	2-16
2.6	Airspeed Indicator	2-18
2.7	Barometric Altimeter	2-22
2.8	VSI	2-29
2.9	Horizontal Situation Indicator	2-32
2.10	CDI	2-38
2.11	LDI	2-44
2.12	VDI	2-45
2.13	CDI/VDI Preview	2-47

SUPPLEMENTAL FLIGHT DATA

2.14	Bearing Pointers	2-50
2.15	GPS NAV Status Field	2-52
2.16	Relative Wind Data	2-53
2.17	Temp/DALT Display	2-54
2.18	DME Display	2-55
2.19	Marker Beacon Symbols	2-56
2.20	AGL Display	2-57
2.21	Clock/Timer	2-58
2.22	GPS Roll Indicator	2-59

Primary Flight Display



The PFD menu provides access to various controls, sub-menus, and setup options.

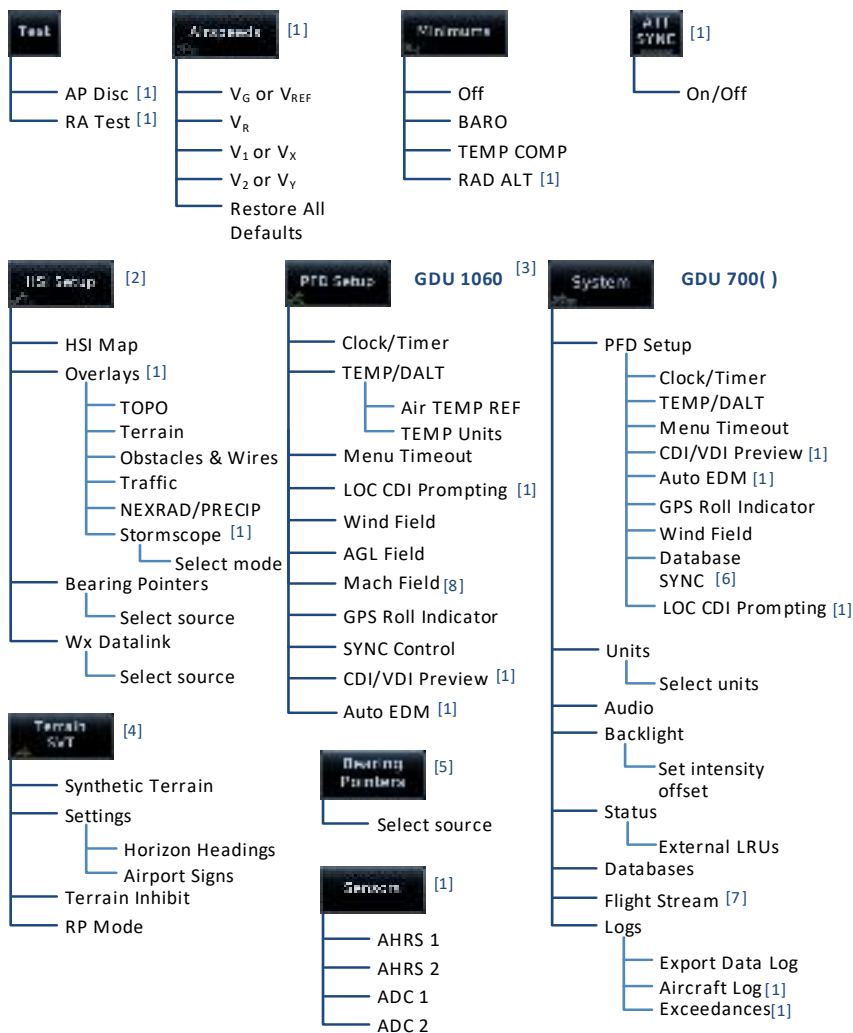

[1] Dependent upon unit configuration .

[2] Not available on GDU 700L PFD.

[3] Units, audio, backlight, status, and database options are located in the System page of the MFD.

[4] Menu functions pertain to the specified terrain function.

[5] GDU 700L only.

[6] In multi-PFD systems, a SYNC Control page access key replaces Database SYNC. Options are dependent upon display type.

[7] Requires Flight Stream 510 wireless datacard.

[8] Available when configured for Mmo.

PFD Setup

PFD SYSTEM SELECTIONS, GDU 700()

For GDU 700(), setup selections are accessible from the **System Menu** key.

PFD Setup	<ul style="list-style-type: none"> • Access CDI/VDI Preview, Auto EDM, LOC CDI Prompting, and Wind Field functions • Access synchronization options (BARO, CDI, and DB) • Control clock/timer • Control Outside Air Temp/Density Altitude display • Toggle Wind Field on or off • Set menu display timeout • Control Database SYNC • Toggle AGL Field on or off • Toggle Mach Field on or off • Toggle GPS Roll Indicator on or off
Units	<p>Except where noted, unit selections synchronize across all configured GDUs. Certain LRUs may contain unit settings independent of the TXi system.</p> <ul style="list-style-type: none"> • NAV Angle • Temperature • Wind Speed • BARO Pressure • Distance <p>Altitude unit settings do not affect the altitude tape.</p>
Audio	<ul style="list-style-type: none"> • Set click volume
Backlight	<ul style="list-style-type: none"> • Adjust display brightness
Status	<ul style="list-style-type: none"> • View unit and software information • Check status of all configured LRUs
Databases	<ul style="list-style-type: none"> • View information about active and standby databases • Perform a manual database update
Flight Stream	<ul style="list-style-type: none"> • Access Bluetooth Setup and Wi-Fi Setup menus
Logs	<ul style="list-style-type: none"> • Access data, aircraft, and exceedance logs

PFD SETUP SELECTIONS, GDU 1060

For GDU 1060, setup selections are available on the System page of the MFD.

Clock/Timer	<ul style="list-style-type: none"> Control clock/timer
TEMP/DALT	<ul style="list-style-type: none"> Control Outside Air Temp/Density Altitude display Specify air temperature units and reference type
Menu Timeout	<ul style="list-style-type: none"> Set menu display timeout
LOC CDI Prompting	<ul style="list-style-type: none"> Allow prompts for switching the CDI source from GPS to LOC [2] [3]
Wind Field	<ul style="list-style-type: none"> Control wind field function
CDI/VDI Preview	<ul style="list-style-type: none"> Enable preview indicators for VDI Glidepath/Glideslope deviation, and VOR/LOC course and deviation [1]
Auto EDM	<ul style="list-style-type: none"> Enable automatic EDM [4]
SYNC Control	<ul style="list-style-type: none"> Access synchronization options (BARO, CDI) [5]
Database SYNC	<ul style="list-style-type: none"> View information about active and standby databases Perform a manual database update
AGL Field	<ul style="list-style-type: none"> Display GPS height above terrain (AGL)
Mach Field	<ul style="list-style-type: none"> Display Mach number when speed exceeds 0.4 Mach [6]
GPS Roll Indicator	<ul style="list-style-type: none"> Display GPS navigator's roll steering command [7]

[1] Available only when a configured GTN is present.

[2] Available only when a configured GPS/NAV navigator (GTN 650/750 or GNS 430/530) is present.

[3] For installations with a GFC 600 or GFC 500 autopilot: LOC CDI prompting is suppressed when the autopilot is armed to capture the localizer. The TXI CDI source automatically switches from GPS to LOC once the autopilot couples to the localizer.

[4] Available only with GFC 600 installation and cabin altitude threshold configured.

[5] Available for systems with multiple sources.

[6] Available when M_{MO} value is configured.

[7] Indicator is hidden when flight director is active.

2.1 Synchronization Options

FEATURE LIMITATIONS

- Multi-PFD systems only
- SYNC Control availability dependent upon configuration



Selecting **SYNC Control** opens a pop-up menu. Selected functions synchronize across all TXi PFDs.

GDU 1060: The database synchronization option resides on the MFD System Status page.

SELECTION	FUNCTION
BARO	<ul style="list-style-type: none"> • Synchronizes the current barometric pressure value [1]
CDI SRC	<ul style="list-style-type: none"> • Synchronizes the selected CDI source [1]
DB	<ul style="list-style-type: none"> • Initiates the database synchronization function • GDU 700() only

[1] Selection not available if synchronization function is configured as always on.

2.2 Reference Bugs and Controls

PFD Controls

- Airspeed
- Altitude
- Barometric Correction
- Heading
- Vertical Speed
- Selected Course

The PFD relies on touchscreen and control knob interactions for instrument and course adjustments.

Only one control is active at a time. Control automatically reverts to heading 10 seconds after the last entry is made.

Additional information shown is determined in menu and setup, including synthetic vision depictions and HSI Map overlays.



Reference Bugs & Controls

SETTING A REFERENCE BUG

Selecting any control opens a dedicated menu. Available options are dependent upon system configuration.



GDU 700L

On GDU 700L: Menu slides out from the left side of the screen.

On GDU 700P/1060: Menu slides up from the bottom of the screen.



GDU 700P/1060

There are three methods for operating PFD controls:

1. Touch and Turn

Touch the control to move knob focus to that control, then:

- turn inner knob to change the selected value

OR

- push knob to synchronize with the current value

2. Turn and Turn

Turn outer knob to move knob focus to the desired control, then:

- turn inner knob to change the selected value

OR

- push knob to synchronize with the current value

3. Touch and Touch (GDU 700P/1060)

Touch the control and use the keys provided in the associated context menu.

- Center key opens a keypad for numeric entries
- Additional controls reside on the left and right

Heading

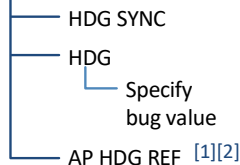

Altitude

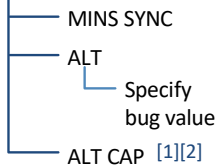

Vertical Speed

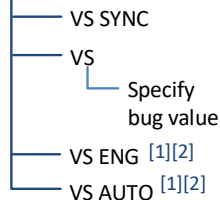

Airspeed

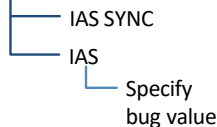

Course

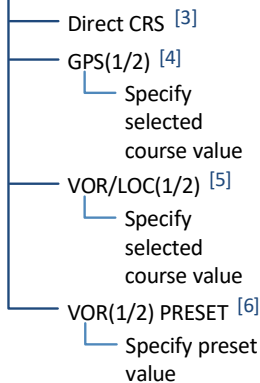

Barometer

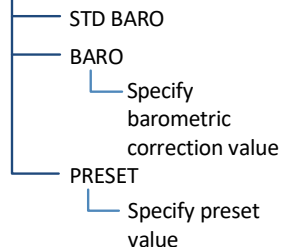

Clock/Timer

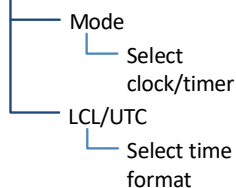

[1] Requires an autopilot.

[2] Not applicable to all autopilots.

[3] Requires an active GPS source.

[4] Available during OBS mode only.

[5] Available only when VOR/LOC is the active CDI source.

[6] Preset course functionality not available when GDU 620 is present (multi-PFD systems only).

Reference Controls & Menu Options

Flight Instruments

Supplemental Flight Data

- GPS Navigation Status
- DME
- Radar Altitude
- Wind
- Clock/Timer

The top portion of the display provides attitude and air data.

The lower portion provides a horizontal situation indicator and supplemental flight data fields.



PFD Portrait Layout

Primary Flight Display



PFD Landscape Layout, Rotorcraft

2.3 Attitude Indicator

The attitude indicator provides a virtual representation of the ground and sky.

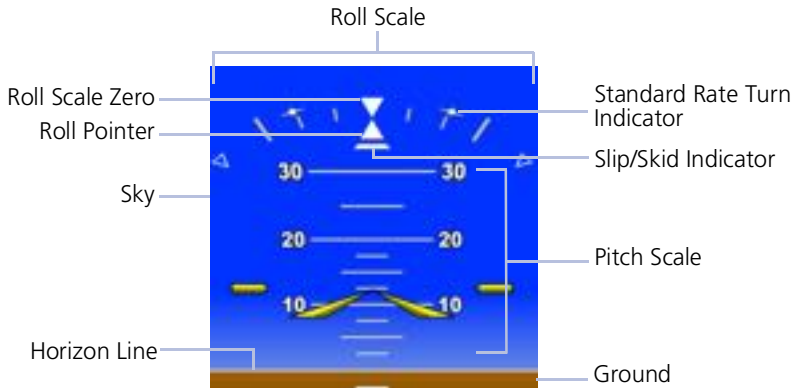

ROLL POINTER



Fixed Pointer



Sky Pointer

The roll pointer indicates angle of bank at varying degrees on the roll scale.

Pointer type is configured at installation as either fixed or sky.

- Major tick marks: 30° and 60°
- Minor tick marks: 10°, 20°, and 45°

STANDARD RATE TURN INDICATORS

Standard Rate Turn Indicators



- Show the required bank angle needed to maintain a standard rate turn
- Dynamically change position based on True Airspeed
- Remain at 30° when TAS is at or above 210 kts

Standard rate turn indicators are removed when:

- TAS is invalid
- TAS is less than 60 kts
- Aircraft is on the ground

SLIP SKID INDICATOR



- Moves laterally away from roll pointer center (max 7° side-slip indication)
- Alignment with roll pointer denotes coordinated flight
- If attitude data becomes invalid, slip/skid indicator is removed

PITCH SCALE

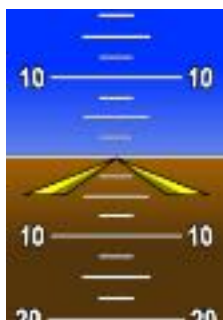

- Markings range between -90° and 90° angles
- Major pitch graduations occur every 5° with SVT and 10° without SVT
- Each minor pitch mark is 5° from 25° nose down to 45° nose up
- Precision pitch marks are at each 2.5° from 20° nose up to nose down attitude

AIRCRAFT SYMBOL



Fixed Wing



Rotorcraft

Depending on aircraft type, aircraft symbol is either fixed wing or rotorcraft.

Symbol type is dependent upon configuration. For requirements, consult the POH.

AWARENESS BANDS

Ground Awareness Band



Appears when current pitch attitude causes the sky presentation to completely fill the display.

Sky Awareness Band



Appears when current pitch attitude causes the ground presentation to completely fill the display.

2.3.1 Attitude Sync, Rotorcraft Only

FEATURE LIMITATIONS

- Rotorcraft only
- Availability dependent upon configuration

Function disables when:

- Current pitch and horizon line differ by more than $\pm 8^\circ$
- Attitude data is invalid

ATT SYNC KEY



- Synchronizes aircraft symbol to the horizon line for all configured GDUs
- Reference marks provide an absolute pitch reference
- Useful during pitch up or pitch down maneuvers



Attitude Sync Off



Attitude Sync On

2.4 Extreme Attitude Indications

To aid in recovery from extreme pitch attitude, red chevrons are shown between major pitch marks from 80° nose down to 30° nose down, and from 80° nose up to 50° nose up. The red chevrons always point towards 0° pitch.



Extreme Pitch

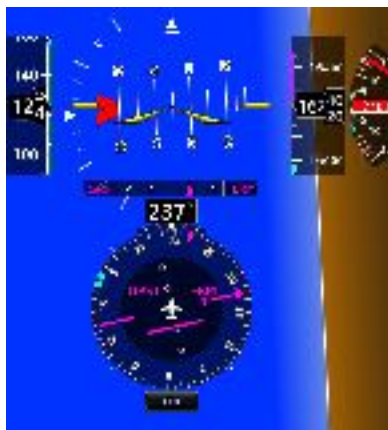

Extreme Roll

The PFD incorporates an extreme attitude declutter mode to improve instrument scan and facilitate aircraft recovery from extreme attitudes. The PFD declutters if pitch exceeds 20° nose down or 30° nose up, or bank angle exceeds 65°.

When selected, the extreme attitude declutter mode changes the enhanced HSI back to the standard HSI. If previously selected, once extreme attitude declutter mode is exited, the HSI returns to the enhanced HSI.

Data removed during extreme attitudes

- Open menus and keyboards
- GS
- TAS
- Air temperature
- Flight director command bars
- Marker beacon annunciation
- Vertical deviation indicator
- Clock/timer
- Selected Altitude control
- Vertical Speed control
- Selected IAS
- Bearing pointer information field(s)
- GPS navigation status
- Fast/Slow indicator
- **CDI** source selection key
- PFD **Menu** key
- PFD **Full** key (GDU 1060 only)
- Standard rate turn indicators
- GPS height above terrain (AGL)
- Wind field
- Selected heading
- Selected course
- Barometric pressure setting
- DME
- **Advisory** key

AHRS(1/2) KEY



- Allows pilot to change the current AHRS source while extreme attitude decluttering is in effect
- Replaces **PFD Menu** key during extreme attitudes

2.5 VNAV Guidance Indications



WARNING

DO NOT RELY SOLELY ON VNAV GUIDANCE WHEN NAVIGATING HORIZONTALLY AND VERTICALLY AROUND USER-DEFINED AIRPORTS. IT IS THE PILOT'S RESPONSIBILITY TO ENSURE SEPARATION FROM TERRAIN AND OBSTACLES DURING AN APPROACH TO A USER-DEFINED AIRPORT.

FEATURE REQUIREMENTS

- Configured GTN (v6.50 and later)
- Valid VNAV data
- GFC 500/600 for autopilot VNAV mode status annunciation

The vertical navigation (VNAV) feature provides vertical profile guidance during the descent phase of flight. Guidance is based on altitude constraints associated with lateral waypoints in the active flight plan.

VNAV Guidance Function

- Presents vertical path guidance along the descent as either a line joining two waypoints with specified altitudes or a desired linear vertical path (i.e., the vertical angle from the specified waypoint or altitude)
- Integrates vertical waypoints into the active flight plan
- Supports both manual and autopilot coupling

VNAV PFD INDICATIONS

VNAV data received from the navigator display as magenta indications on the PFD.



INDICATOR	VNAV DATA
Barometric Altimeter	<ul style="list-style-type: none"> • Target altitude reference field • Modified selected altitude knob increments
VSI	<ul style="list-style-type: none"> • Required vertical speed indication
VDI	<ul style="list-style-type: none"> • VNAV source and vertical deviation indications
AP Mode Banner	<ul style="list-style-type: none"> • VNAV mode annunciation (requires Garmin autopilot)

2.6 Airspeed Indicator



Airspeed indicator is configured at installation to meet the requirements of the AFM/POH. Available units: knots (default), kilometers per hour, and statute miles per hour.

Supports ten custom airspeed tape markings with installer configurable labels.

For required airspeed limitations and markings, refer to the aircraft AFM/POH.

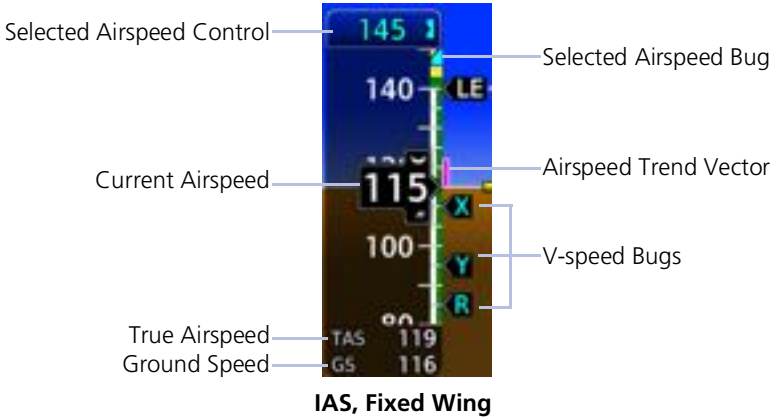

Airspeed Indicator Function

- Provides indicated airspeed, true airspeed, and ground speed
- Provides Mach numbers above Mach 0.4 when M_{MO} is set. Mach indicator is hidden below Mach 0.4
- A fixed pointer, with rolling number gauge, indicates current airspeed on a moving tape
- Actual airspeed tape colors and markings vary by installation
- Data fields display true airspeed, ground speed, and, for some configurations, Mach
- As airspeed increases, tape scrolls down

AIRSPEED CONTROLS & INDICATIONS	
Selected Airspeed	<ul style="list-style-type: none"> • Sets airspeed bug on tape if configured • Both the bug and its digital value display in cyan • Automatically synchronizes across all connected TXi PFDs • Not selectable during EDM selected data lockout (both field and bug turn gray)
Airspeed Trend Vector	<ul style="list-style-type: none"> • Magenta trend vector at the right of the airspeed tape • 6 second prediction of airspeed based on current acceleration • Removed if airspeed remains constant or if any data necessary to calculate airspeed is not available due to a system failure
Speed Range Strip	<ul style="list-style-type: none"> • Multi-colored strip at the right of the moving tape • Actual colors and patterns vary according to aircraft type
Selected Airspeed Bug	<ul style="list-style-type: none"> • Set using the selected airspeed control • Present on the right, inboard side of the tape if configured • Parks at the top or bottom of the tape when selected airspeed is outside the visible range • Changes from cyan to gray during EDM selected data lockout

2.6.1 Reference Markings

FIXED WING

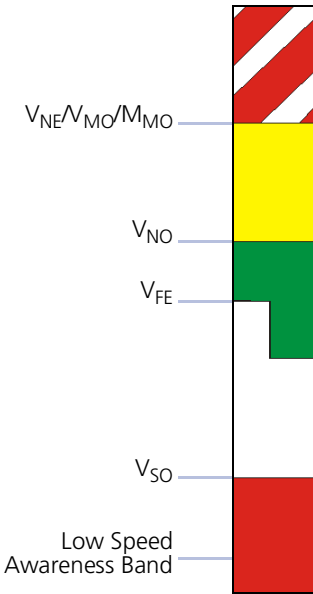

The V_{NE}/V_{MO} barber pole and V_{NO} yellow range are configurable as fixed values or variable values that change with altitude. M_{MO} may be configured when a variable V_{NE}/V_{MO} is configured.

For configurations with multiple variable $V_{NE}/V_{MO}/M_{MO}$ or V_{NO} values, the bottom of the indicating range and alerting parameters extend to the lowest airspeed based on calculations.

For fixed wing installations, exceeding a variable $V_{NE}/V_{MO}/M_{MO}$ value creates an airspeed exceedance entry.

A white triangle reference marking is configured for airframes that are placarded with approach flap speed limitations.

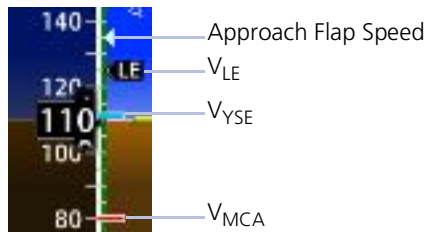

ROTORCRAFT

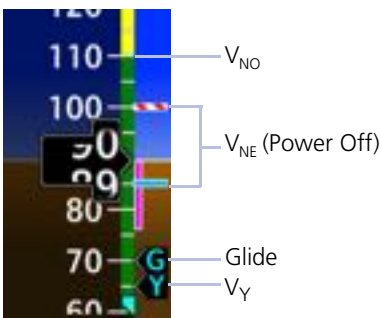

Two types of markings are available for denoting maximum auto rotation speed (V_{NE} power off). This option is configured during installation.

Variable V_{NE} is based on values in the airspeed limitations placard.

OVERSPEED INDICATIONS

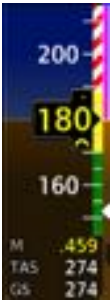

If the trend vector enters the overspeed range, the current airspeed and Mach values turn yellow.



If current airspeed exceeds $V_{NE}/V_{MO}/M_{MO}$, the indicator backgrounds turn red.

2.6.2 Reference Speeds

Selectable airspeed reference bugs are available for both fixed wing aircraft and rotorcraft. On/off controls reside in the Airspeeds page of the PFD menu.

Fixed wing Reference Speeds:

Glide or V_{REF} V_Y or V_2 V_X or V_1 V_R

Rotorcraft Reference Speeds:

Glide V_Y

V_X , V_Y , V_R and Glide default values are set during the installation process. V-speeds can be set for an individual flight, but will default back to install presets after a power cycle. When active (on), the V-speeds are displayed at their appropriate locations on the right of the airspeed tape.

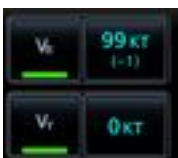

A positive or negative value indicates the difference between the currently selected V-speed and its default value.

Restore All Defaults resets all V-speeds to their default values.

2.6.3 Fast/Slow Indicator



PC-12 AIRCRAFT ONLY

The Fast/Slow indication displays on left edge of PFD.

The indicator shows when indicated airspeeds are less than 150 KIAS, and the aircraft is configured for initial climb, or approach and landing conditions. For details on operation, consult the POH/AFM.

2.7 Barometric Altimeter

FEATURE LIMITATIONS

- 20 ft (20 m) digital resolution
- Range: -1,000 to 99,000 ft (-305 to 30175 m)

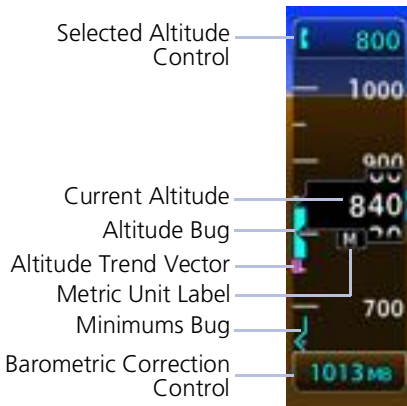

Barometric altitude is displayed on a moving tape with a fixed pointer and digital readout.

Units are either feet or meters depending on configuration. A metric unit label displays for metric altitudes.

Altimeter tape limits are configured to match aircraft performance. For more information, consult the AFM/POH.

ALTIMETER CONTROLS & INDICATIONS	
Selected Altitude	<ul style="list-style-type: none"> • Sets altitude bug on altimeter when configured • Bug automatically synchronizes across PFDs • If barometric minimums is set, selected altitude may be set to same value as barometric minimums • Determines visual and aural alerts for approaching and deviating from selected altitude. • Not selectable during EDM selected data lockout (both field and bug turn gray) • Provides source data for the range to altitude arc display on MFD map (GDU 1060 only) • Controls altitude preselect mode for various autopilots • Bug is removed upon system startup or by rotating control knob to a value <-1,000 ft
Altitude Trend Vector	<ul style="list-style-type: none"> • Magenta trend vector at the left of the altitude tape • 6 second prediction of altitude based on current vertical speed • Absent if aircraft altitude remains constant or if data needed for rate calculation is not available due to a system failure
Barometric Correction Control	<ul style="list-style-type: none"> • Displays in cyan digits at the bottom of altimeter tape • Pilot can select units to display in inches of mercury (in Hg), Hectopascals (hPa), or Millibars (Mb) • Digits display in yellow when pilot and co-pilot TXi PFD settings differ by more than 0.03 in Hg • Barometric Pressure Setting to 29.92 in. / 1013 Mb setting when STD BARO is selected
Minimums Bug	<ul style="list-style-type: none"> • Displays as a colored bracket for selected MDA/DH minimums set on the altimeter tape • Bug is parked to the top or bottom of altimeter tape when value is outside current visible range • Cyan bracket denotes BARO or RAD ALT minimums altitude • Magenta bracket denotes TEMP COMP minimums altitude • White bracket denotes close proximity above minimums altitude • Yellow bracket denotes below minimums • Triggers "Minimums, Minimums" aural alert at MDA/DHs

ALTIMETER CONTROLS & INDICATIONS

Altitude Bug

- Set using the Selected Altitude
- A portion of the bug displays at the top or bottom of the altitude tape if selected Altitude Bug is out of visible range
- Bug width is 100 units wide, depicting (+/-) 50 unit increments
- Turns gray during EDM selected data lockout

TARGET ALTITUDE REFERENCE FIELD

The location of this field varies depending on PFD layout.

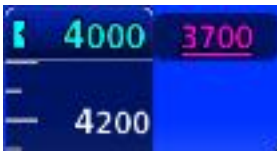

**GDU 1060/700L
(Full Screen View)**

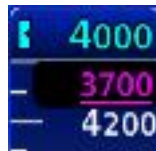

**GDU 700P
GDU 700L (Menu Open)
GDU 1060 (MFD/PFD/EIS)**

A magenta bar indicates target altitude in relation to the current altitude.



**At or above
target altitude**



**At target
altitude**



**At or below
target altitude**

2.7.1 Adjusting Barometric Pressure



Controls for adjusting barometric pressure reside in the Barometer control menu.

SETTING	FUNCTION
STD BARO	<ul style="list-style-type: none"> • Toggles between standard barometric pressure and the pilot specified value
BARO	<ul style="list-style-type: none"> • Allows entry of selected barometric pressure value • Available only when STD BARO is inactive
PRESET	<ul style="list-style-type: none"> • Allows entry of destination barometric pressure while the aircraft is above transition level (FL 180) • Preset does not affect altimeter readout • Transitioning from standard to preset sets the altimeter to the preset value • Available only when STD BARO is active

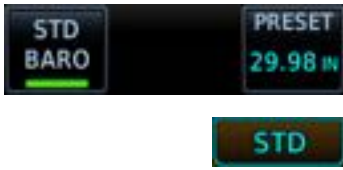

When **STD BARO** is active:

- The barometric setting field below the altimeter annunciates **STD**
- The barometer preset value may be changed
- Changes to the preset value are displayed in a pop-up field above the barometric setting field

SET BAROMETRIC PRESSURE

1. Tap the barometric setting field or turn the PFD control knob to select the field.
2. Push the inner control knob or tap the **STD BARO** key to select standard barometric pressure or pilot-selected barometric pressure.
3. If **STD BARO** is active, turn the inner knob or tap the **PRESET** key to set the barometer preset value.
4. If **STD BARO** is not active, turn the inner knob or tap the **BARO** key to set the barometer current value.

2.7.2 Adjusting Selected Altitude

FEATURE REQUIREMENTS

The MINS SYNC function is available only when the following conditions are met.

- Minimums source is configured as barometric altimeter or temperature compensated barometric altimeter
- **BARO** source key is active
- A valid minimums altitude setting



Adjustments to the selected altitude value cause the alert function to reset.

SELECTION	FUNCTION
MINS SYNC	<ul style="list-style-type: none"> • Synchronizes altimeter bug to the MDA/DH setting
ALT	<ul style="list-style-type: none"> • Allows entry of a selected altitude value • Inner knob adjustments are in 100 ft increments

SELECTED ALTITUDE ALERTING

Visual and aural indications alert when the aircraft is approaching the selected altitude.

DISTANCE FROM SELECTED ALTITUDE	INDICATION [1]
1,000 ft	<ul style="list-style-type: none"> • Flashing black text on white background • Optional aural tone [2]
200 ft	<ul style="list-style-type: none"> • Flashing cyan text on black background • Optional aural tone [2]
0 ft Altitude deviates more than ±200 ft from selected altitude	<ul style="list-style-type: none"> • Flashing yellow text on blue background • Aural tone

[1] Alert duration: five seconds

[2] Aural tone dependent upon configuration.

DISABLE ALTITUDE BUG



Turn inner knob counterclockwise until the selected altitude value is < -1,000 ft. Values less than -1,000 display as a series of dashes.

2.7.3 Temperature Compensation Minimums

FEATURE REQUIREMENTS

- The TEMP COMP minimums function is available only when a destination airport is present on the external navigator
- Cycling power to the GDU clears all minimums data

GTNs and TXi displays use only one destination airport temperature for calculating compensated altitudes. Changing the temperature on one of these units automatically recalculates the value across all connected GTNs and GDUs.

TEMP COMP KEY



- Calculates compensated altitude for the destination airport
- Indicates temperature compensated minimums on altitude tape
- Synchronizes destination temperature between the GDU and

Selecting this key when a destination airport temperature is not available automatically opens the TEMP at DEST keypad. Specify a temperature value to enable the function.

MINIMUMS BUG INDICATION



Compensating the approach minimums bug determines the location of the minimums reference on the altimeter. It does not adjust barometric altitude.

When temperature compensation is active, the minimums bug and numeric value turn magenta.

Set Temperature Compensated Minimums:



1. Tap **Altitude**. Specify the minimums altitude value.
2. Tap **TEMP at DEST**. Specify the destination airport's current temperature.



GDU automatically calculates the compensated value. By default, this field displays the compensated minimums altitude.

Loading a different destination airport into the flight plan causes GDU to recalculate the compensated altitude based on the elevation of the new destination airport.

If the destination airport is lost (e.g., the pilot clears the flight plan on the navigator):

- Temperature compensation is unavailable
- Minimums altitude source type switches from TEMP COMP to BARO

To resume temperature compensation, reselect **TEMP COMP** after loading a new destination airport into the navigator.



Both TEMP COMP and BARO share the minimums altitude function. Switching between these two source types does not alter the specified altitude value.

2.7.4 MDA/DH Alerting

MDA and DH alerts are based on barometric altitude or optional radar altitude. Alerting is inhibited while the aircraft is on the ground. The radar altimeter option is only available in aircraft with a compatible radar altimeter interfaced to the TXi system.

Both radar altitude and barometric minimums settings are lost following a unit power cycle. Controls for setting MDA and DH alerting behavior reside in the Minimums menu.

CONDITION	ALERT INDICATION
Initial MDA/DH	When the MDA/DH is initially set: <ul style="list-style-type: none">• Cyan altitude value with bracket pointer displays at the bottom of the altimeter tape• BARO or RAD ALT minimums remain boxed until the MDA/DH altitude is visible on the altimeter tape• Minimums display "RA" when using RAD ALT settings Once MDA/DH altitude is within altitude tape display range, the boxed value is removed and the cyan minimums bug begins tracking with the altimeter tape.
Within 100 ft of MDA/DH	<ul style="list-style-type: none">• Bug turns white
Reaching MDA/DH	<ul style="list-style-type: none">• Bug turns yellow• RA value turns yellow.• Aural alert: "Minimums, minimums"

As the aircraft descends, the bug changes color to reflect the current altitude above minimums. Alerting is armed once the aircraft is >150 ft above min altitude.

- White at 50 ft above min
- Cyan at 150 ft above min

RA value turns white once the aircraft is on ground (i.e., system detects weight on wheels; TAS is < 50 kt).

2.8 VSI

Vertical speed data displays on either a standard or arc style indicator. Format is dependent on unit type (portrait or landscape) and installer configuration.

Arc VSI

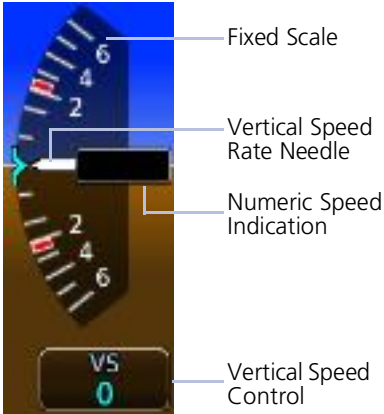

Moving needle indicates current vertical speed on a fixed scale.

Standard VSI

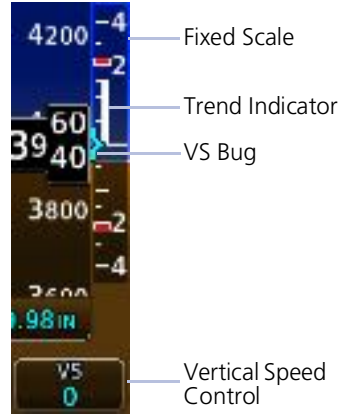

Trend indicator replaces needle, pointer, or indications.

AUTOMATIC FORMAT CHANGES

The arc format changes to standard when alternating between full and split views (arc during full PFD, standard during split). This occurs in the following display configurations.

GDU 1060 MFD/PFD/EIS or MFD/PFD (60%/40%)

GDU 700L PFD/menu open

TCAS II RAs

The TCAS II uses transponder replies to determine relative altitude, range, and bearing of any air traffic control radar beacon system (ATCRBS) or Mode S equipped aircraft with altitude reporting. Based on the information TCAS II determines the level of advisory. The TCAS II will not issue RAs for ATCRBS aircraft that reply with only Mode A information.

Requirements:

- Installed GTS 8000 or compatible ARINC 429 TCAS II unit
- GDU 1060 with 60% PFD or 700L PFD
- Standard style VSI



When the TCAS II LRU issues an RA, the VSI displays red no-fly bands to indicate areas to avoid. The green band indicates the desired climb/descent rate.

NUMERIC SPEED INDICATION

GDU 1060/700L: A numeric field displaying current vertical speed is available on both standard and arc VSIs. The type of field depends on indicator format and, in the case of arc VSI, aircraft type.



Standard VSI: This field replaces the trend indicator and moves up or down as the vertical speed changes. It displays only in expanded layouts.

GDU 1060: full screen PFD, split MFD/PFD, and split PFD/EIS
GDU 700L: full screen PFD



Arc VSI: Field behavior is dependent upon aircraft type:

For rotorcraft, a stationary field appears when vertical speed exceeds +/- 300 fpm (1.5 mps).

For fixed wing aircraft, the digital value is always present.

VERTICAL SPEED RANGE

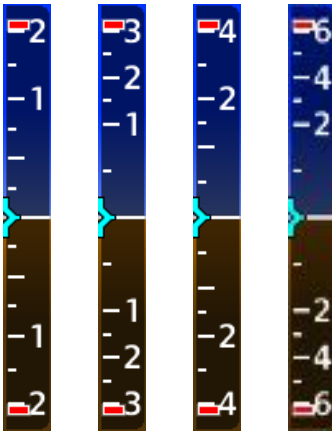

Fixed Scale Range Options

Vertical speed range is dependent upon aircraft performance. Both range and units are configured at installation.

Available range types include:

+/- 2,000 FPM

+/- 3,000 FPM

+/- 4,000 FPM

+/- 6,000 FPM

Metric:

+/- 15 MPS

+/- 9 MPS

+/- 21 MPS

+/- 30 MPS

REQUIRED VERTICAL SPEED INDICATION



When receiving VNAV data from the navigator, a magenta chevron indicates the rate of descent needed to reach target altitude.

2.8.1 Selected Vertical Speed



Controls for setting the vertical speed bug reside in the VS control menu. Selected VS bug limits are determined by the visible tape range.

SELECTION	FUNCTION
VS SYNC	<ul style="list-style-type: none"> Synchronizes selected VS bug to current vertical speed
VS	<ul style="list-style-type: none"> Allows entry of a numeric vertical speed

2.9 Horizontal Situation Indicator

The HSI displays a rotating compass card in a heading-up orientation. Letters indicate the cardinal points with numeric labels every 30°. Major tick marks are placed at 10° intervals and minor tick marks are at 5° intervals. The HSI displays:

- Digital reading of the current heading
- A magenta diamond representing current track
- Turn rate, course deviation, bearing, and navigation source information

HSI layout varies according to display type.

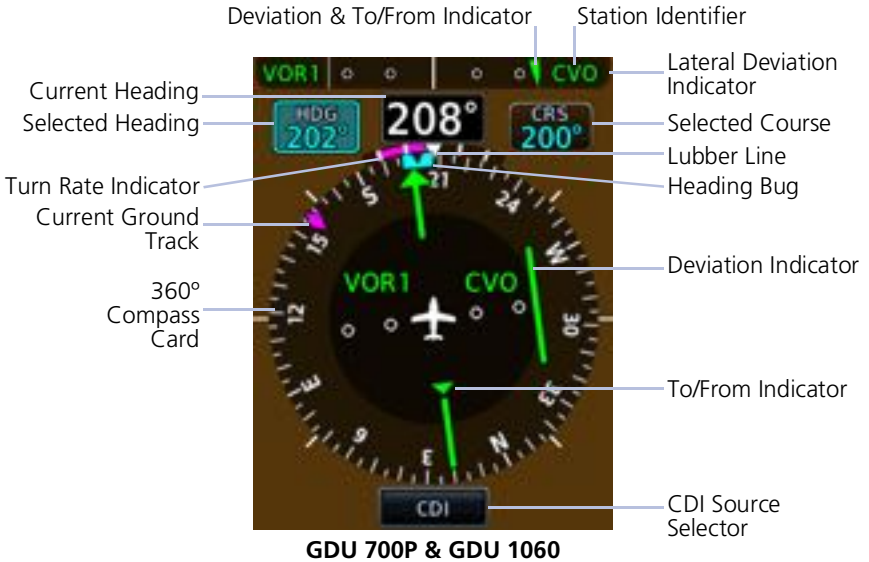

GDU 700P & GDU 1060

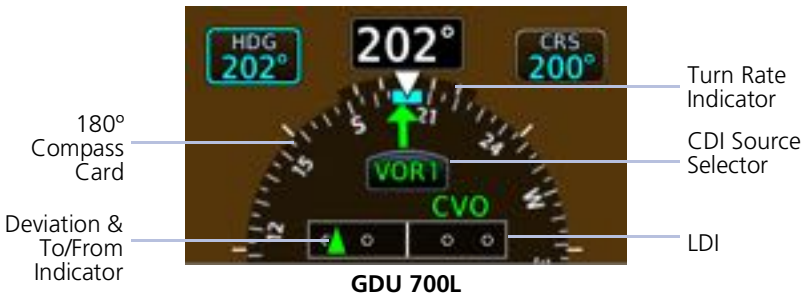

GDU 700L

HSI CONTROLS & INDICATIONS	
Turn Rate Indicator	<ul style="list-style-type: none"> • Lubber line serves as apex for the turn rate indicator, displaying aircraft centerline and direction straight ahead • Tick marks closest to the lubber line depict half-standard rate turns and tick marks furthest away denote a standard rate turn • 6 second prediction of heading based on present turn rate • If aircraft turn rates are greater than 4° per second, an arrowhead appears at the end of the vector and a heading prediction is no longer valid
Lateral Deviation Indicator	<ul style="list-style-type: none"> • Lateral movement of symbols indicate course deviation • GPS flight phase, navigation source, OBS status, and message annunciator display on deviation indicator borders
Current Ground Track	<ul style="list-style-type: none"> • Magenta diamond moves on compass card indicating aircraft current track over ground
Current Heading	<ul style="list-style-type: none"> • Heading displays true north or magnetic values by selecting NAV Angle units from the System Units menu
To/From Indicator	<ul style="list-style-type: none"> • Rotates with the course pointer on the standard HSI depicted as an upright or inverted triangle • Displays only when an active navigation source is received (GPS or VOR) • Color scheme is uniform with GPS and VOR/LOC source selections • Upward pointing symbol indicates to, downward pointing symbol indicates from
Station Identifier	<ul style="list-style-type: none"> • For VOR/LOC sources, the HSI displays the decoded Morse code station identifier on the right side of the CDI lateral deviation indicator • Station Identifiers display at the center of the HSI when HSI map overlays are selected off
Heading Bug	<ul style="list-style-type: none"> • Cyan bug on the compass card corresponds to the selected heading • Selected heading is adjustable using the PFD knobs or touchscreen controls

2.9.1 Setting the Heading Bug

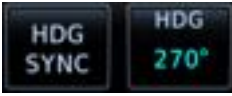

Controls for setting the heading bug are located in the Selected Heading control menu.

GDU 700L: Set the heading bug using the inner control knob.

SELECTION	FUNCTION
HDG SYNC	<ul style="list-style-type: none">• Synchronizes heading bug to current heading
HDG [1]	<ul style="list-style-type: none">• Allows entry of a numeric heading

[1] Touch key not available on GDU 700L.

OFF SCALE INDICATION



Heading Bug Off Scale

GDU 700L: It is possible for the heading bug position to be out of view on the 180° compass card. When this occurs:

- Heading bug parks on the side nearest to its actual position (a partial bug is visible at the bottom of the screen)
- Down arrow indicates direction







2.9.2 HSI Annunciations

HSI annunciations display on the HSI compass card and around the lateral deviation indicator. They include:

- GPS flight phase
- CDI source
- VOR/LOC station Morse Code identifier (when VOR is active)
- Navigator modes and messages
- Cross track error (if CDI deflects beyond full scale)



NAVIGATOR ANNUNCIATIONS

ANNUNCIATION	LOCATION	DESCRIPTION
	Within Lateral Deviation Indicator	Waypoint Alert blinking text depicts arrival at a waypoint.
	Above Lateral Deviation Indicator	GPS waypoint sequencing suspended.
	Above CDI Lateral Deviation Indicator	Loss of GPS Integrity Alert. GPS integrity is insufficient for the current phase of flight. GPS information is not present or is invalid for navigation use.
	Above CDI Lateral Deviation Indicator	Message Flag blinking text signaling a message is queued in the navigator.
	Above CDI Lateral Deviation Indicator	Omnibearing Selector Active.
	Within CDI Lateral Deviation Indicator/Center of HSI	CDI Source displays current CDI source information.

GPS FLIGHT PHASE AND ANNUNCIATIONS

GPS Flight Phase Annunciation Locations

- CDI lateral deviation indicator
- Center of the HSI

Phase of flight annunciations are a direct indication of the current CDI behavior for the selected navigation source. Not all annunciations are available for every navigator.

Flight phase annunciations are typically shown in magenta. The color changes to yellow when cautionary conditions exist.

ANNUNCIATION	FLIGHT PHASE
0.3NM	0.3 nm CDI scale
1NM	1.0 nm CDI scale
DPRT	Terminal level with departure procedure as the active navigation
DR	Dead reckoning (CDI not available)
ENR	En route
HDG LEG	Navigator provides heading information only (CDI not available)
LNAV	Lateral Navigation Approach
LNAV+V	Lateral Navigation Approach with advisory vertical guidance provided. LNAV+V uses published LNAV minimums.
L/VNAV	Lateral and Vertical Navigation Approach
LP	Localizer Performance Approach
LP +V	Localizer Performance Approach with advisory vertical guidance provided. LP +V uses published LP minimums.
LPV	Localizer Performance with Vertical guidance approach.
MAPR	Missed Approach
OCN	Oceanic
TERM	Terminal
VISUAL	Visual Approach

2.10 CDI

FEATURE LIMITATIONS

- CDI angular limits are $\pm 10^\circ$ when the navigation source is VOR or LOC

The CDI is located in the center of the standard HSI compass card, and is duplicated using a sliding lateral deviation indicator above the HSI. Control knob selection of CRS can set the course pointer, while the CDI source is VOR/LOC or GPS course when OBS mode is active.



Standard HSI







CDI Above HSI Map

The CDI is capable of displaying up to four sources of navigation depending on external navigator and navigation radio configuration. The CDI does not display if course deviation data are invalid.

2.10.1 Course Pointer Types

Course pointer type varies between single or double line arrows depending on the active CDI source. Arrow tips point in the direction of the selected course or GPS desired track.

ICON	SOURCE
	LOC1, VOR1
	GPS1

ICON	SOURCE
	LOC2, VOR2
	GPS2

2.10.2 Cross Track Error Indication



The GPS navigator determines CDI scaling. A cross track error displays if the CDI exceeds the full scale deviation value during GPS navigation.

Cross Track Error Annunciation

2.10.3 CDI Source Selection



CDI key toggles between two sources or opens a source selection menu to select between more than two sources.



On GDU 700L: Source selections display on the **CDI** key.

For systems with a GTN that has a GTN CDI key, the CDI source may be switched between GPS and VOR from a PFD or with the GTN CDI key.

CDI SOURCE SYNC

When CDI SRC sync is on or the system is configured to always sync, the CDI source selected on any PFD is automatically selected on all PFDs in the system.

In a system with two or more navigation units available as CDI sources (GPS/VOR 1 and GPS/VOR 2) and CDI SRC sync off, the CDI source can be selected on each PFD independently.

SOURCE SELECTION ALERT

The **CDI** key flashes to alert the pilot when a change in source selection is necessary. Conditions include:

- Localizer or ILS approach is active on the GPS navigator
- Active waypoint is the final approach fix
- Localizer deviation is less than full scale deflection
- Localizer approach course is within 20° of GPS track

2.10.4 Selected Course with VOR/LOC



Selecting a VOR/LOC source activates the Selected Course control. All course indications and annunciators turn green.

Selecting **Direct CRS** centers the VOR CDI needle and sets a direct-to-fix course.

2.10.5 Selected Course with GPS

FEATURE LIMITATIONS

- In multi-PFD systems, preset course functionality is not available when GDU 620 is present

When a GPS source is selected, the Selected Course field displays course values in magenta. This function provides the preset course for VLOC guidance upon switching from GPS to VOR or LOC.



Selecting **VOR(1/2) PRESET** allows the pilot to preset VOR course selected course entries. Access this function by tapping the preset key and entering the value on the numeric keypad or by turning the inner control knob on the PFD.

GPS AUTO displays the automatic course computed by the navigator. There is no touch key available. Selected GPS course cannot be changed during non-OBS GPS operation.

2.10.6 Automatic Source Selection

FEATURE REQUIREMENTS

- Integrated GPS and NAV radio source (GTN 650/750 or GNS 430/530) for VOR/LOC to GPS auto-switch functionality during missed approaches
- GTN 650/750 for GPS to LOC auto-switch functionality during localizer approach

FEATURE LIMITATIONS

- In multi-PFD systems, the missed approach auto-switch function disables when GDU 620 is present

The system automatically changes the navigation source during the following conditions.

CONDITION	CDI RESPONSE
Missed approach procedure activates	Navigation source automatically switches from VOR/LOC to GPS.
Autopilot captures the localizer	Navigation source automatically switches from GPS to LOC. [1] [2]

[1] GFC 500/600 autopilot only.

[2] GFC 500 localizer autoswitch available only with GTN software v6.70 and later.

2.10.7 Auto-Slewing

FEATURE LIMITATIONS

- In multi-PFD systems, auto-slew functionality is not available when GDU 620 is present

When changing the CDI source from GPS to LOC, the system auto-slews the selected course to the localizer course if:

- A localizer-based approach exists in current flight plan of GPS navigator
- A localizer frequency is active in navigator (LOC, BC, SDF, ILS, LDA)

When a LOC BC approach is activated, the course pointer slews to the LOC front course to provide appropriate back course HSI needle indications.



Course Selection and Pointer Auto-Slewed to 313°

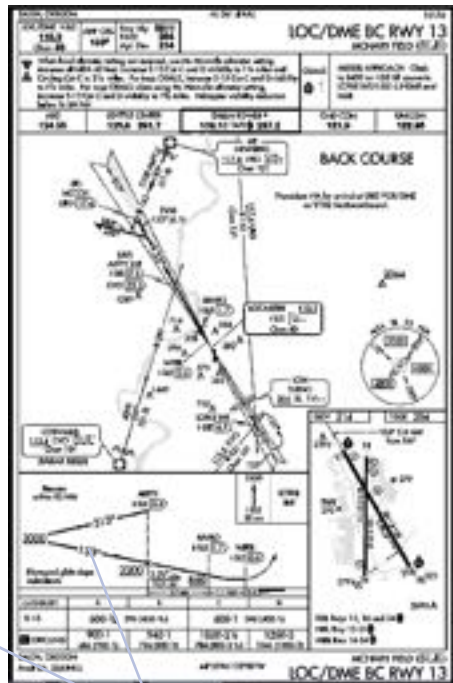

Final Inbound Approach Course 133°

2.11 LDI

Deviation indicators move left or right along the CDI scale to portray aircraft position relative to the selected course.

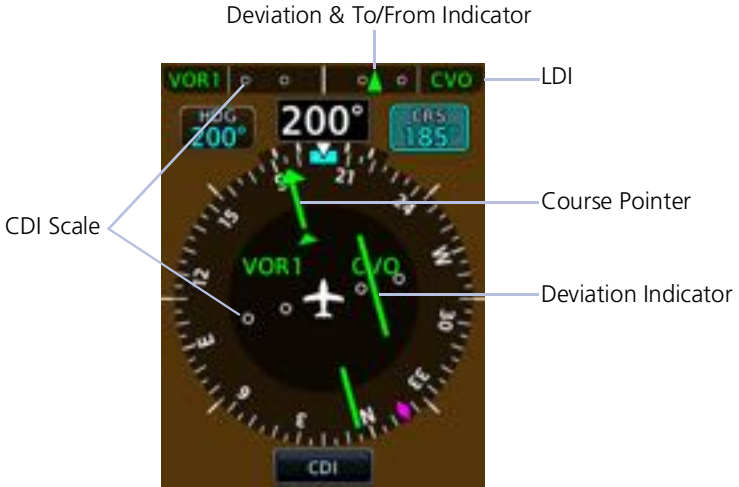

2.11.1 Reverse Sensing Correction

The lateral deviation indicator incorporates an automatic reverse sensing correction. When the aircraft heading is more than 107° left or right from the selected course, the lateral deviation indicator will reverse CDI indications and the to/from pointer.



2.12 VDI

The VDI displays to the left of the altitude tape when:

- The aircraft is in an ILS or GPS approach with vertical guidance
- The GDU is receiving VNAV vertical guidance from the GTN

Status annunciations replace VDI indications when data is invalid or not available.



ILS Glideslope

For ILS glideslope indications, the VDI is a green diamond. An ILS glideslope indication appears if the current heading is within 107° of the selected course. This prevents the glideslope from displaying during localizer backcourse approaches.



No GS

Annunciates if a localizer frequency is tuned and there is no glideslope signal.



GPS Glidepath

GPS glidepath vertical guidance is similar to glideslope indications. A magenta diamond glidepath indication displays for GPS approaches supporting vertical guidance (LNAV+V, L/NAV, LPV, LP +V, VISUAL).



No GP

Annunciates if GPS glidepath data becomes invalid while the VDI is displayed.

2.12.1 VNAV Deviation Indications

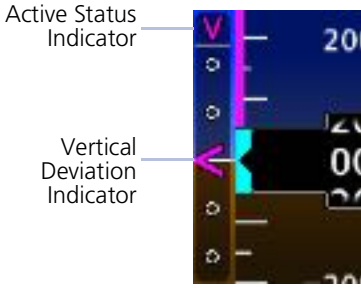

VNAV deviation guidance displays when:

- CDI source is GPS and the navigator is providing valid VNAV deviation data
- CDI source is VOR/LOC, the navigator is providing valid VNAV deviation data, and a VNAV mode is armed or active on the autopilot

These indications are absent when deviation data is invalid.

MAXIMUM DEFLECTION INDICATIONS

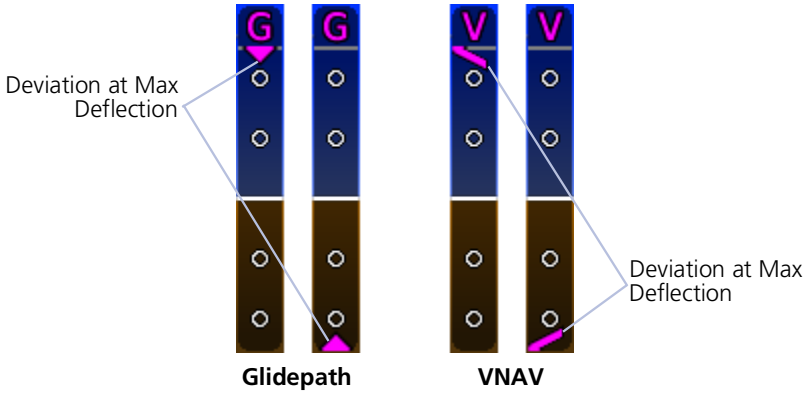

2.13 CDI/VDI Preview

FEATURE REQUIREMENTS

- Configured GTN



A preview option provides advance indications of approach lateral and/or vertical deviations, allowing the pilot to anticipate changes and make smooth transitions during approach. By default, this function is active.

All preview indications and annunciations are gray.

Approach Preview Data

- CDI Source [1]
- CDI VOR/LOC Deviation [2]
- HSI Map VOR/LOC Course
- VDI Glidepath/Glideslope
- VOR/LOC Course
- VOR/LOC Morse Code ID

[1] Only if Morse code is not available.
 [2] Includes LOC backcourse deviation.

VDI PREVIEW

For ILS and GPS approaches, the VDI provides a preview of glideslope or glidepath deviation.

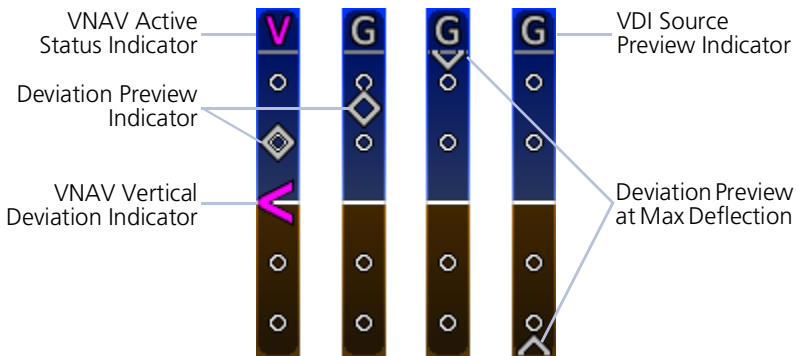

CDI PREVIEW

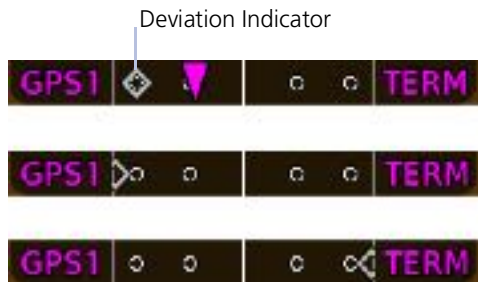

Deviation Indicator

For VOR or ILS approaches, the CDI provides a preview of VOR or localizer deviation.

LDI

GDU 1060 & GDU 700P:



Course Pointer Preview

Lateral Deviation Preview

VLC Station ID Preview

Numeric Course Preview

HSI

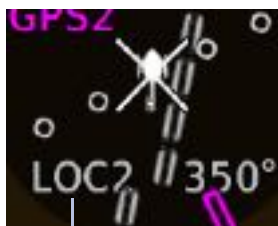

CDI Source Preview

If a VLC station ID is not available, the CDI source annunciates in its place (e.g., VOR, LOC).

To change the course preview:

1. Open the Course control menu.
2. Select **VOR/LOC PRESET**.
3. Specify a new preset value.

GDU 700L:

Preview data include a course pointer and lateral deviation indicator.



Supplemental Flight Data

2.14 Bearing Pointers

FEATURE LIMITATIONS

- Bearing pointers are mutually exclusive with the HSI Map. They do not display when HSI Map is active.

Selecting a bearing pointer does not necessarily make it visible. Bearing pointers are absent when:

- GDU does not receive valid data from the selected source
- NAV radio is not receiving tuned VOR station
- NAV radio is tuned to a Localizer frequency
- GPS is bearing source and active waypoint is not selected
- ADF is selected and signal is not received
- HSI Map function is on

ICON	BEARING
	1.
	2.

Two selectable bearing pointers are available for the display of VOR, GPS, or ADF data.

Arrow tips point to signal source in relation to the current aircraft heading.

Pointers do not override CDI features.

Bearing Information Fields



GDU 700L

Bearing information fields indicate bearing type and navigation source. They display to the left and right of the compass card.

SET BEARING POINTERS

1. Turn off HSI Map if necessary.
2. Navigate to the Bearing Pointers page.
3. Select a bearing navigation source for the active pointer(s).

The GDU retains all pointer selections during a unit power cycle.

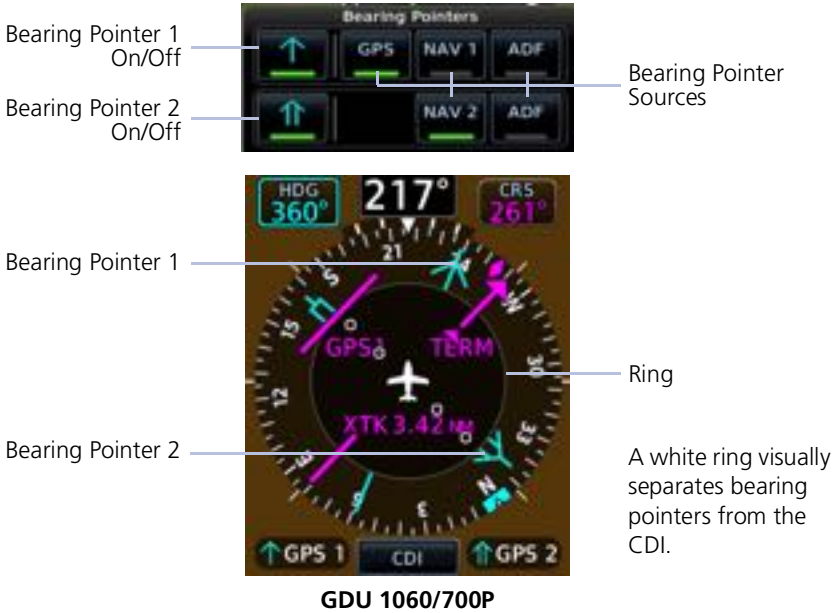

2.15 GPS NAV Status Field

FEATURE LIMITATIONS

- From and next waypoints may be removed when the number of characters in a full route exceeds the allowable space

A GPS NAV status field displays at the bottom of the PFD when the GPS navigator associated with the selected CDI source has an active valid leg. Information is based on calculations by the GPS navigator. Annunciations and window width vary according to GDU type.

GDU 700P/1060:

- From, to, and next waypoints
- Leg and waypoint types
- Identifier, distance, and ETE of active waypoint

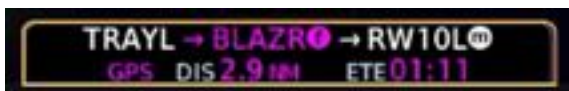

GDU 700L:

- Active waypoint identifier and distance
- GPS message status



ACTIVE LEG GPS NAVIGATION STATUS FIELD SYMBOLS



IAF



Arc Left



FAF



Holding Pattern
(Right Turns)



MAP



Holding Pattern
(Left Turns)



MAHP



Right Arrow



Parallel Track



Direct To



Arc Right

2.16 Relative Wind Data

Wind Data

- Wind direction and speed
- Headwind (H)
- Tailwind (T)
- Crosswind (X)

The system computes current wind conditions during flight and displays the data in a dedicated field.

Status annunciations replace wind data when conditions are calm or the configured data source is invalid or not available. Wind data displays when ground speed is 30 knots and higher.

A white arrow indicates wind direction relative to the aircraft's heading. The numeric display of the wind direction is dependent on the NAV Angle system unit setting.



WIND STATUS ANNUNCIATIONS

Wind
Calm

Calculated winds are less than or equal to 2.5 kts.

No Wind
Data

GPS track or TAS data are invalid or unavailable.

2.17 Temp/DALT Display



A dedicated field displays outside air temperature or density altitude based on pilot selection. These reference values are mutually exclusive. Selecting one automatically turns off the other.

Outside Air TEMP



Displays the pilot selected air temperature reference.

Units are available in °C or °F.

Options include:

- Static Air Temperature
- Total Air Temperature
- Temperature difference from ISA

Density Altitude



Displays pressure altitude corrected for nonstandard temperature.

Units display in increments of ten, and are in feet or meters depending on altitude tape configuration.

2.18 DME Display

When the GDU is configured with a GAD 43e and interfaced with a DME receiver, a selectable DME information window is available for display. Information includes the DME source (NAV1, NAV2, EXT, or HOLD) and distance.

When a DME signal is invalid, “--- NM” replaces the distance.



DME HOLD activates/deactivates the DME tuning hold function and can be selected for either DME NAV 1 or DME NAV 2.

Switching between NAV1 and NAV2 automatically cancels the function. Not all installations have the DME HOLD function.

2.19 Marker Beacon Symbols



Inner Marker
Symbol

Marker beacon symbols display left of the altitude tape when interfaced to a marker beacon receiver. All marker beacon light and audio tests are performed through controls on the associated audio panel.

SYMBOL	MARKER TYPE
I	Inner
M	Middle
O	Outer

2.20 AGL Display

The GDU indicates height AGL to the left of the altitude tape. The altitude field automatically appears when the aircraft is at or below 2,500 ft AGL or within operating range of the installed RA unit (generally 2,500 ft AGL). Radar height is shown when a radar altimeter is interfaced to the system. GPS height is shown on systems without a radar altimeter.



For systems without a radar altimeter, **AGL Field** may be toggled on or off in the PFD Setup menu.

Brown and white hash marks depict a ground awareness band on the altimeter tape. When the radar altimeter readout is 0 ft, the ground band will level with the altitude pointer.



As the aircraft climbs, the ground band moves down the tape in equal amounts to the indicated RAD ALT value.

Ground Band



If the radar altimeter fails, the message "RA FAIL" annunciates in place of the current radar value.

Audio Alert (Rotorcraft Only)



Depending on configuration, an audio alert is active when the radar altimeter or GPS indicates the aircraft is descending below 100 ft.

2.20.1 RA Test

FEATURE LIMITATIONS

- Self-test functionality is not available on all radar altimeters
- Sequence duration is approximately 12-20 seconds
- For test values and unit limitations, consult the appropriate third party radar altimeter documentation



A test function verifies communication between the GDU and the radar altimeter.

During the test sequence:

- Ground awareness band displays on the altimeter tape
- RA readout field displays a test altitude value (e.g., 50 ft AGL)

To suspend the test, deselect **RA Test** or exit the Test menu.

2.21 Clock/Timer

A generic timer counts up in an H:MM:SS format. There are no aural alerts or pilot advisories associated with this feature. Turning the clock/timer function off removes the control key from the instrument display.



Mode: Toggles between Clock & Timer.

Start/Stop: Pauses timer.

Reset: Resets timer to zero. Count resumes when the timer is reset during operation.

2.22 GPS Roll Indicator

A magenta GPS Roll Indicator adjacent to the roll pointer provides roll steering guidance during GPS navigation. The GPS navigator's roll steering command is used to drive the indicator whenever valid AHRS roll, GPS deviation, and GPS roll steering values are available and the flight director is inactive.

GPS Roll Indicator - Fixed View



GPS Roll Indicator - Sky View



INTENTIONALLY LEFT BLANK

3 Advanced Features

HSI MAP

3.1	HSI Map Overlays	3-4
-----	------------------------	-----

MAP DISPLAY, GDU 700L

3.2	GDU 700L Map Overlays	3-9
-----	-----------------------------	-----

SVT

3.3	SVT Setup	3-12
-----	-----------------	------

3.4	SVT Features	3-13
-----	--------------------	------

AUTOPILOT

3.5	GPSS	3-20
-----	------------	------

3.6	Flight Director	3-22
-----	-----------------------	------

3.7	Altitude Preselect Functions	3-24
-----	------------------------------------	------

3.8	Low Bank Mode	3-25
-----	---------------------	------

3.9	Servo Heading Reference	3-25
-----	-------------------------------	------

3.10	Mode Annunciations	3-26
------	--------------------------	------

3.11	Autopilot Preflight Test	3-30
------	--------------------------------	------

HSI MAP

FEATURE REQUIREMENTS

- Valid GPS position and magnetic heading
- FIS-B, Iridium transceiver, or SiriusXM receiver (weather overlays only)
- Active weather subscription (Connex and SiriusXM only)
- WX-500 receiver (Stormscope only)
- Valid VNAV data (ATK waypoints)

FEATURE LIMITATIONS

- GDU 700P/1060 only



Tapping **HSI Map** places a map within the HSI. This key resides in the PFD menu.

HSI MAP INTERACTIONS

- Map interactions are zoom only. Pan functionality is not available
- Overlays declutter at a predefined map range for specified data depictions

WHEN HSI MAP IS ACTIVE

- Standard HSI view expands to incorporate a basemap and selected overlay
- Map overlays replace standard HSI indications
- HSI display enlarges to a 270° compass card view to accommodate the map
- CDI and annunciations are removed
- CDI indications appear only on the LDI
- Status icons indicate active map overlays
- Bearing pointers do not display
- HSI reverts to a standard depiction in the absence of a valid magnetic heading or GPS source

Data depicted when HSI Map is active

- GPS flight plan
- Airspace boundaries and altitudes
- TFRs
- Runway and SafeTaxi detail
- Range to altitude arc
- Terrain alerts, if configured



Standard HSI



HSI Map

HSI ARC

When a heading bug, track indicator, course preview pointer, or course pointer moves to a position on the HSI circle behind or below other PFD controls, indicators depict on a miniature arc, representative of the hidden portion of the HSI circle.



HSI Arc

CDI



LDI

LDI indications include:

- CDI source
- Course deviation
- GPS phase of flight
- Course deviation preview
- Navigator message annunciations
- To/from
- VLOC station identifier
- Waypoint arrival annunciation

GPS NAV Status Field

3.1 HSI Map Overlays

TOPO



- Topographic map depicting terrain elevation using a color scale similar to Sectional Charts

TERRAIN



- Terrain map depicting terrain elevation relative to aircraft altitude
- Uses the same color scale as the dedicated Terrain page
- NEXRAD weather overlay is disabled to prevent confusion of depicting radar and terrain data with similar colors

OBSTACLES AND WIRES



- Depicts obstacle and wire elevations relative to aircraft altitude
- Uses the same color scale as the dedicated Terrain page
- Data removed when viewing range is >5 nm

TRAFFIC



- Displays traffic using a NORMAL altitude filter
- Data removed when viewing range is >20 nm

NEXRAD/PRECIP & TFRS

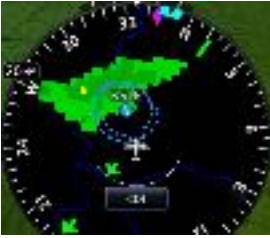

- Overlays NEXRAD/PRECIP datalink weather from ADS-B [5], SiriusXM, or Garmin Connex [1] [2] as selected in the HSI Setup menu
- Precipitation intensity displays in accordance with NEXRAD/PRECIP legend viewable on the dedicated weather page
- Weather and TFR product age display on HSI Setup Menu

STORMSCOPE



- Overlays Stormscope strike or cell data on map [3]
- Data is removed after 4 minutes

LIGHTNING



- Depicts SiriusXM, FIS-B, or Connex lightning strike information on the basemap [1] [4]

- [1] Requires aircraft to be equipped with appropriate datalink receiver and an active datalink weather subscription service, if applicable. FIS-B is not a subscription based service.
- [2] NEXRAD/PRECIP and terrain overlay functions are mutually exclusive. Enabling one automatically disables the other.
- [3] Requires aircraft to be equipped with appropriate WX-series Stormscope system.
- [4] Stormscope and SXM lightning overlay functions are mutually exclusive. When one is installed and selected in the PFD menu, the other is not available.
- [5] When displaying FIS-B NEXRAD data, the overlay is set to display the Regional product.

3.1.1 Overlay Status Icons

Icons represent the presence of overlay data. For real time products (e.g., TFRs, NEXRAD/PRECIP), these icons indicate the recency of data.

The absence of an overlay icon means one of two possible conditions:

1. Overlay is not present at the current zoom level.
2. Overlay control is off.



Obstacles overlay data is active on the display.



Power line overlay data is active on the display.



TFR overlay is active.



Terrain overlay is active on the display.



Traffic system is active and displaying information.



NEXRAD or PRECIP overlay is active and displaying received information.



Lightning overlay is active and displaying SiriusXM, FIS-B, or Connex lightning information.



Stormscope overlay is active and displaying lightning strikes.

FAULT INDICATION



A fault icon means overlay data is not available, not received, or has failed (where relevant).

OLD DATA



An old data icon means overlay data is not current, but remains displayed.

Map Display, GDU 700L



Tapping **Map** overlays a full screen map on the PFD.

FEATURE LIMITATIONS

- GDU 700L only
- Rotorcraft
- Map display feature must be configured as available

MAP INTERACTIONS

- Map interactions are single-finger zoom controlled
- Pan functionality is not available
- Overlays declutter at a predefined map range

WHEN MAP IS ACTIVE

- VFR style moving map with 360° compass card replaces standard PFD layout
- Road and city information display in support of VFR operations
- Airspeed, altitude, BARO correction, and ground speed values display within a selectable attitude indicator key
- Display automatically returns to full screen PFD in the event of extreme attitudes
- PFD Menu key changes to accommodate only the map display

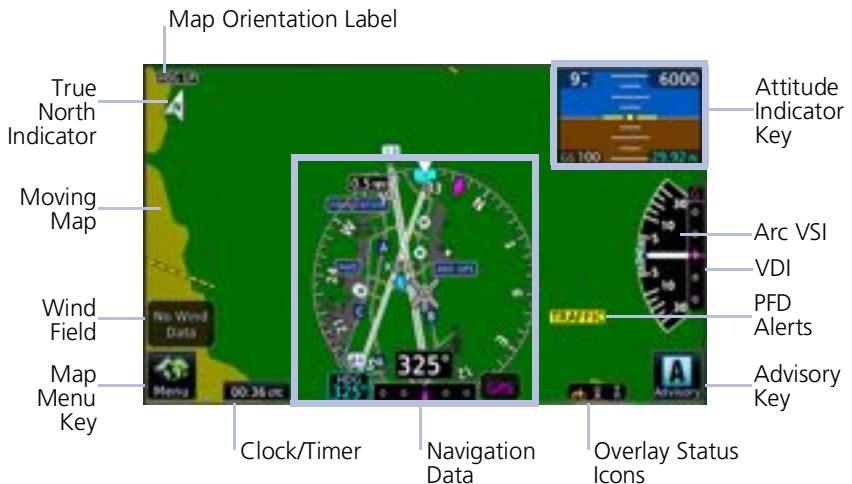

GDU 700L PFD Map Features

Data depicted when PFD Map is active

- Full compass card view
- Lubber line and heading bug
- Current ground track
- Selected Heading control and current heading field
- Selected BARO control
- Reduced attitude display
- Arc VSI (if configured)
- Wind field
- Clock/timer
- Autopilot annunciations
- Active fix and distance to active fix (if available from the navigator)

ATTITUDE INDICATOR KEY

To return to full screen PFD, tap the attitude indicator key. This key displays a reduced attitude depiction and instrument data fields. It resides in the upper right corner of the display when full screen map is active. Data fields are display only.

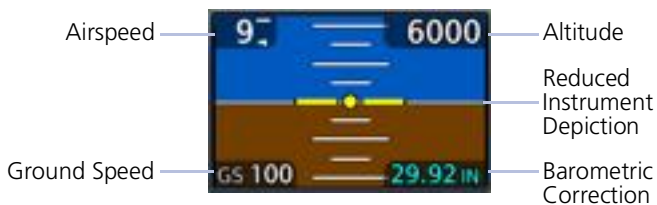

Attitude Indicator Key

360° COMPASS CARD



3.2 GDU 700L Map Overlays



Tapping **Menu** while the map is active opens an overlay menu. Overlay selections display in a dedicated menu.

Overlay Selections

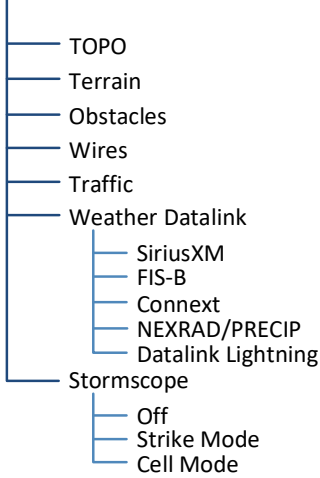

3.2.1 Overlay Controls



Control keys enable the specified overlay function only and do not activate interfaced equipment. Overlay keys remain active even in the absence of required data.

GDU 700L MAP OVERLAYS	
TOPO	<ul style="list-style-type: none"> • Overlays topographical data and ground elevation scale • Depictions are similar to a VFR sectional
Terrain	<ul style="list-style-type: none"> • Overlays terrain map data • Color shading depicts terrain elevation relative to the aircraft's altitude
Obstacles & Wires	<ul style="list-style-type: none"> • Depicts obstacle and wire elevations relative to aircraft altitude • Uses the same color scale as the dedicated terrain page • Data removed when viewing range is >5 nm
Traffic	<ul style="list-style-type: none"> • Overlays traffic information • Filter selection on Traffic page determines altitude range • Optional
NEXRAD/PRECIP & TFRs	<ul style="list-style-type: none"> • Overlays NEXRAD/PRECIP datalink weather from ADS-B, SiriusXM, or Garmin Connex as selected in the Overlay menu • Precipitation intensity displays in accordance with NEXRAD/PRECIP legend viewable on the dedicated weather page • Weather and TFR product age display
Stormscope	<ul style="list-style-type: none"> • Overlays Stormscope strike or cell data • Data is removed after 4 minutes

3.2.2 Overlay Status Icons

Icons indicate which overlays are present at the current map range. A crossed out icon means the overlay is active, but data is unavailable due to a failure, test, or standby condition (where relevant).

The absence of an overlay icon means one of two possible conditions:

1. Overlay not present at the current detail level or zoom setting.
2. Overlay control is off.



Obstacle



Power Line



Stormscope



Traffic



Terrain



Data not available

SVT



NOTE

Synthetic terrain aids pilot awareness of terrain and obstacles in front of the aircraft. It does not replace primary flight instruments.

FEATURE REQUIREMENTS

- Valid attitude and magnetic heading
- Valid 3-D GPS position
- Valid terrain and obstacle databases
- Feature enablement to continue service beyond the free trial period

FEATURE LIMITATIONS

- Loss of any required data, including temporary loss of GPS, causes SVT to be removed until data is restored
- Depicts only terrain contours and obstacles from the associated databases. Optional depictions (e.g., airport signs, aircraft heading) are dependent upon pilot selections. Power line depictions are not available
- SVT terrain alerting functionality is not compliant with TSO-C151c
- Aural and visual alerting functions are in accordance with appendix H.2 of AC 20-167A

3.3 SVT Setup



SVT setup selections are accessible via the **Terrain/SVT** key.

SELECTION	FUNCTION
Synthetic Terrain	Activate SVT function.
Settings	Activate horizon heading markings and airport signs.
Terrain Inhibit	Deactivate Terrain aural and visual alerts.

3.4 SVT Features



NOTE

GDUs with PFD functionality have a 10-hour free trial of SVT. A timer in the Terrain/SVT menu indicates current trial status. For details on how to enable SVT once the trial expires, refer to section 3.4.8.

SVT presents a forward looking view of the terrain, obstacles, and traffic surrounding the aircraft. This optional feature offers a visual enhancement to the PFD.

SVT Features	
PFD	MFD
<ul style="list-style-type: none"> • Terrain Alerting • Obstacle Alerting • SVT Alert Inhibit • Flight Path Marker • Zero Pitch Line • Arc-second Grid Lines • Horizon Heading Marks • Traffic Display • Airport Signs • Runway Display • 3-D Alert Symbols 	<ul style="list-style-type: none"> • Terrain Alerting • Obstacle Alerting • SVT Field of View • SVT Alert Inhibit Controls

3.4.1 Pitch Scale Expansion

When SVT is active, the pitch scale expands to display fewer degrees of pitch. This change in scale is necessary to maintain an accurate representation of terrain.



Default Pitch Scale

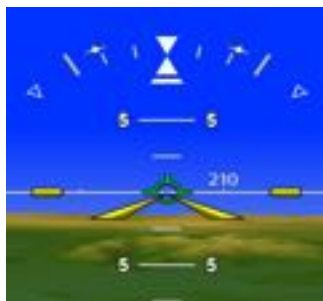

Pitch Scale with SVT

3.4.2 Zero-Pitch Line

This horizontal reference line spans the width of the PFD. It is useful when quickly determining whether the aircraft's current altitude is above or below the approaching terrain.



Zero-Pitch Line Above Mountains

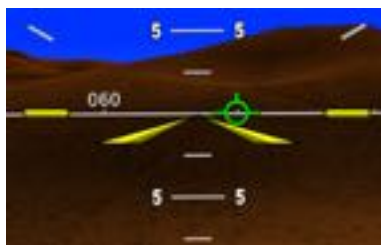

Zero-Pitch Line Below Mountains

3.4.3 Flight Path Marker



WARNING

DO NOT USE THE FLIGHT PATH MARKER AS A FLIGHT DIRECTOR.



Flight Path Marker

The flight path marker displays the aircraft's projected path relative to runways, traffic, terrain, and obstacles.

It indicates the aircraft's current lateral and vertical path, accounting for wind speed and direction relative to the 3-dimensional terrain depiction.

The flight path marker displays when SVT is enabled and active, and ground speed is greater than 30 knots. This is useful when assessing potential conflicts with terrain, obstacles, and traffic.

Displayed terrain or obstacles in the aircraft's flight path depicted extending above the FPM indicate a possible conflict.

3.4.4 SVT Terrain and Obstacles



SVT Features



Depicts terrain in front of the aircraft. Color palette indicates terrain and obstacles at varying elevations.

This imagery derives from the aircraft's attitude, heading, GPS 3-D position, and terrain and obstacle databases.



Two-dimensional symbols represent an obstacle's relative height above terrain and distance from the aircraft.

- Includes towers, power lines, and wind turbines
- Obstacles never obstruct instrumentation
- Size varies according to aircraft proximity

TERRAIN AND OBSTACLE ALERTS

When interfaced to a GTN with TAWS- A, TAWS-B or HTAWS enabled, or when TXi Terrain FLTA or TAWS-B is enabled, terrain and obstacle alerts include alert depictions in SVT.



In the event of a terrain or obstacle alert, SVT shading changes to red or yellow, reflecting alert status.

SVT Warning Shade

SVT Caution Shade



Alerted Terrain

Alerted Obstacles

3.4.5 SVT Runways



Runway depictions provide improved awareness of runway location with respect to surrounding terrain. Runway thresholds correspond to their correct elevation with respect to terrain.

Runways oriented within 45° of aircraft heading are represented in white, others in gray.



The runway is brighter with a white box outline when a runway approach is active. This improves recognition of the intended runway.

Detail is added as the aircraft becomes closer to the runway. This includes runway numbers and centerlines. Taxiways are not shown in SVT.

3.4.6 SVT Traffic

Detected intruders display in their relative location as determined by the aircraft traffic systems. Traffic in 3-D appears larger when closer, and smaller when further away. Intruders above the zero pitch line are above the aircraft's altitude and intruders below are lower.



SVT Traffic Display

A white diamond indicates proximate traffic. A yellow circle indicates alerted traffic.



Proximity Advisory



Traffic Advisory

3.4.7 Selectable Display Features

Pilot selectable display features provide additional indications in synthetic vision.

HORIZON HEADINGS



Horizon heading marks synchronize with the HSI. Tick marks and compass heading display in 30° increments on the zero-pitch line. These markings are not visible behind the altimeter and airspeed indicator.

AIRPORT SIGNS



Signs denote airport location and ID. These indications are useful when flying into an unfamiliar airport.

The type of indication is dependent on the aircraft's approach distance.

To reduce clutter, signs for private airports display only if the airport is in the active flight plan.

RANGE FROM AIRPORT	SVT AIRPORT INDICATION
15 nm	Signpost and frame only.
8 nm	Identifier annunciates within frame.
4.5 nm	No indication (runway visible).

SVT FIELD OF VIEW (MFD)

FEATURE LIMITATIONS

- Available only on GDU 1060
- Displays only when the Synthetic Terrain function is active

SVT Field of View



On MFD:

The Map page offers a depiction of the PFD's lateral view.

Terrain and traffic within this V-shaped indicator are visible in synthetic vision.

3.4.8 G500(H) TXi (H)SVT Enablement

For convenience, (H)SVT enablement is available for download at flyGarmin.com. This process is similar to downloading databases and does not require a visit to the dealer.



You must be the aircraft account holder to download this feature. Contact your Garmin dealer for assistance.

To add (H)SVT to your TXi system:

1. Sign in to your flyGarmin.com account.
2. Select the **Devices** tab, then locate your aircraft and G500(H) TXi unit.
3. Scroll to the "Feature Enablements" section. Select **Buy Enablement** and then complete the checkout process.
4. Insert a blank SD card into the computer/card adapter. Complete the onscreen prompts to create an enablement card.
5. Place the enablement card in the top/left slot of the TXi PFD.
6. Power up all configured GDUs.
7. Activate (H)SVT if necessary.

Enablement occurs upon system startup. While this process is quick, use of a ground power unit or running the engine may be advised depending on the aircraft.

Autopilot

Autopilot Interface Functions

- GPSS
- Flight director
- Mode annunciations
- Half-bank mode
- Altitude capture
- Lateral/vertical deviations
- VS preselect
- Servo heading reference

3.5 GPSS

GPSS provides roll command signals from the navigator to the autopilot in order to:

- Make smooth transitions when passing waypoints
- Fly curved leg types (e.g., procedure turns and holding patterns)

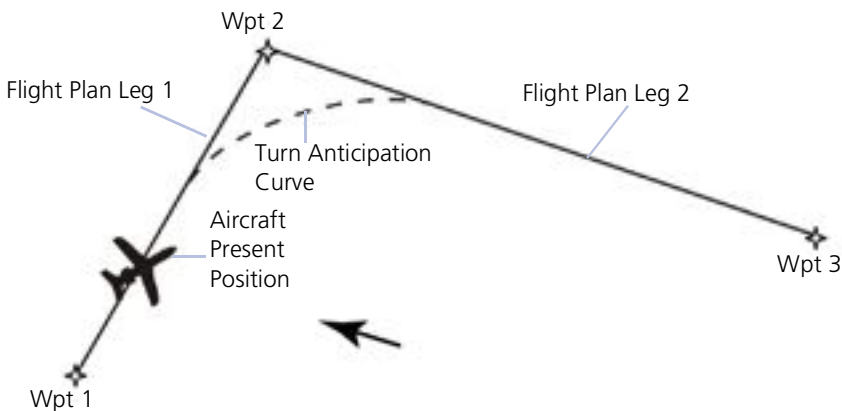

GPSS Turn Anticipation

If the autopilot is capable of receiving GPSS Roll Steering information and when navigating using GPS guidance, data is transmitted through a digital communications bus from the GDU to the autopilot. In dual GPS installations, the PFD sends Roll Steering information for the currently-selected GPS source. For these autopilots there is no pilot action required to use GPSS.

For autopilots that are not GPSS Roll Steering capable, the GDU converts GPSS turn commands into a heading error signal for the autopilot. When autopilot is operated in HDG mode and GPSS is selected on the PFD, the autopilot flies the turn commands from the GPS navigator selected on PFD 1. An additional touchscreen button is provided on the selected heading popup window for toggling the autopilot heading reference between GPSS and selected heading. After setting the heading bug, "GPSS" displays in selected heading field.







The **AP HDG REF** key is present if an autopilot is interfaced with the GDU and is configured to use GPSS emulation. This key changes the autopilot's heading reference between HDG bug and GPSS.

When GPSS is selected:

- Heading bug changes from solid to a cyan outline
- Selection key annunciates a GPSS label

The heading bug may still be adjusted by the pilot as a visual reference without affecting GPSS to the autopilot.

3.5.1 GPSS Mode Icons

ICON	CONDITION
	Roll steering function is active, but no commands are sent.
	GDU is sending roll steering commands to autopilot (pilot side only).
	GDU is sending roll steering commands to autopilot (copilot side or second PFD only).
	GDU is sending selected HDG commands without GPSS. Heading bug on HSI is solid.

3.6 Flight Director

FEATURE REQUIREMENTS

- Autopilot flight director commands interfaced to the TXi system

FEATURE LIMITATIONS

Pilot controls for flight director functions are not available on the GDU. They are available only on the autopilot/flight director controller.

The TXi system limits the distance the flight director commands may deviate from the aircraft attitude icon. If the pitch command provided by the flight director is greater than that allowed by the display, then the command bars will display at the maximum distance allowed by the PFD. As the aircraft pitch changes to satisfy the command bars, the bars will continue display at the maximum distance from the aircraft attitude symbol until the aircraft pitch deviation is within the command display limit.

3.6.1 Command Cues

The Flight Director displays commands from the external flight director on the PFD. Depending on aircraft type, these commands display as either single cue (fixed wing) or dual cue (rotorcraft).

Single Cue

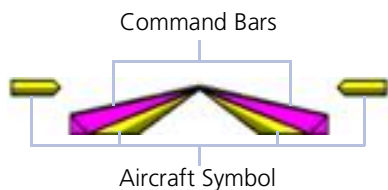

Dual Cue

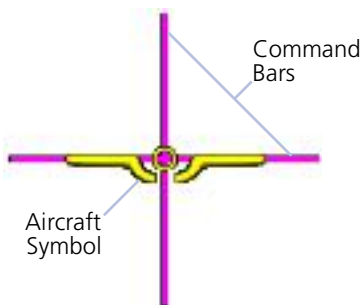

Descend Left Command



Aircraft at Commanded Attitude

Command bars represent pitch and roll guidance.

CONDITION	COMMAND INDICATION
Commanded pitch is greater than GDU maximum allowable limit.	Command bars display at maximum allowable limit.
Aircraft pitch exceeds $-20^{\circ}/+30^{\circ}$.	Command bars and annunciations declutter.
Aircraft roll exceeds $\pm 65^{\circ}$.	
Attitude information becomes invalid or unavailable.	Command bars do not display.

AP ENGAGED INDICATION

For some autopilots, single cue command bars alternate between hollow and solid to show autopilot status.

AP Engaged

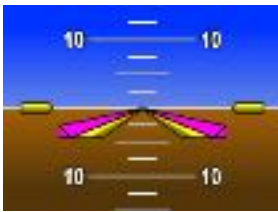

Command bars are solid.

AP Not Engaged

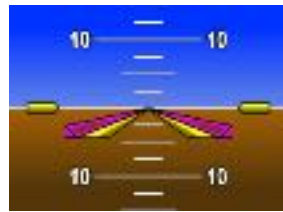

Command bars are hollow.

3.7 Altitude Preselect Functions

FEATURE LIMITATIONS

- Mode availability is dependent upon autopilot type

3.7.1 Arming Altitude Capture

Depending on the autopilot and flight director interface, the GDU provides altitude preselect capabilities. This allows autopilot to capture a preselected altitude.

If arming is required, **ALT CAP** arms the altitude capture function and sets the altitude bug.



1. Specify altitude value.
2. Set **ALT CAP** to "ARMED."

An optional **ARM** key is available on the GCU 485 control panel.

If the autopilot does not support altitude preselect functionality, then the selected altitude selected field acts as an altitude alerter. For more about the selected altitude and altitude alerting functions, refer to section 2.7.

3.7.2 Enabling Vertical Speed Control

Depending on the autopilot and flight director interface, the GDU provides vertical speed commands to autopilots.



1. Specify vertical speed value.
2. Set **VS ENG** to ENGAGED.



VS key label changes to reflect mode status. "AUTO" indicates the autopilot is actively scheduling vertical speed.

3.8 Low Bank Mode

FEATURE REQUIREMENTS

- PFD
- GFC 600 with low bank mode support

This feature is intended for aircraft that operate at high altitude or would otherwise need low bank autopilot support (e.g., multi-engine aircraft experiencing engine failure during takeoff).

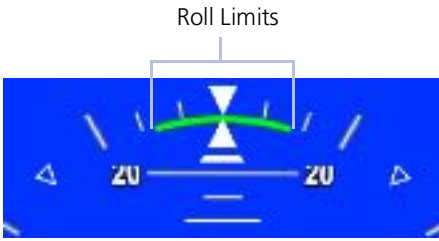

When crossing the altitude threshold, enable low bank mode by activating the associated switch. A green arc appears on the roll scale to indicate the roll limits.

Actual roll limits are determined by the autopilot and based on airframe type.

3.9 Servo Heading Reference

FEATURE REQUIREMENTS

- PFD
- GFC 600

FEATURE LIMITATIONS

- Rotorcraft only

For rotorcraft, the option to beep heading using the yaw beep switch is available while hovering. This displays as the servo heading reference bug on the HSI and as a numeric value in a field adjacent to the HSI.



3.10 Mode Annunciations

FEATURE LIMITATIONS

- Applicable to GFC 500/600, KFC 225/275/325, DFC90

Autopilot mode status annunciates along the top edge of the PFD.

- Green indicates active status
- White indicates armed mode

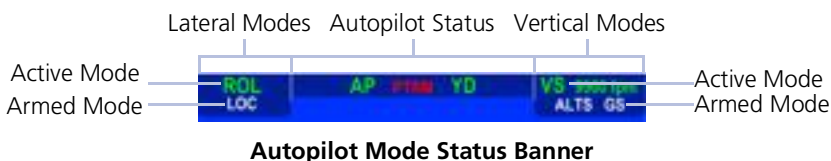

For details about DFC90 autopilot operation and applicable mode annunciations, refer to *Avidyne DFC90 Digital Autopilot Pilot Guide*.

3.10.1 AP Basic Mode Annunciations

ROTORCRAFT ONLY	
ATT	Attitude Retention
CPLD	Flight Director Coupled
FTR	Force Trim Release
PRY	Pitch, Roll, and Yaw

FIXED WING & ROTORCRAFT	
AP	Autopilot
YD	Yaw Damper
CWS	Control Wheel Steering

3.10.2 AP Lateral & Vertical Mode Annunciations

VERTICAL MODE ANNUNCIATIONS	
ALT	Altitude Hold
ALTS	Selected Altitude Capture
APR	Approach
GA	Go Around
GP	Glidepath
GS	Glideslope
IAS	Indicated Airspeed
LVL	Level Hold
PIT	Pitch Hold
VNAV	Vertical Navigation
VPTH	Vertical Path
VS	Vertical Speed

LATERAL MODE ANNUNCIATIONS	
BC	Backcourse Navigation
GPS	GPS Approach
	GPS Navigation
HDG	Heading
LVL	Level Hold
LOC	Localizer Approach
	Localizer Navigation
NAV	Navigation
ROL	Roll Hold
VAPP	VOR Approach [1]
VOR	VOR Navigation

[1] GFC 600 only.

3.10.3 Autopilot Alerts

GFC 500/600 ALERTS, FIXED WING	
ANNUNCIATION	DESCRIPTION
PFT	Preflight test in progress.
PFT	Preflight test failure.
AFCS	Autopilot failure.
AP	Autopilot is automatically disengaged.
AP	Autopilot is manually disengaged. [1]
PTRM	Pitch trim failure. Autopilot may remain engaged. If autopilot disengages, re-engagement cannot occur until after the problem is resolved. May be red or yellow.
↑ELE	Mistrim condition requiring nose up elevator trim.
↓ELE	Mistrim condition requiring nose down elevator trim.
←AIL	Mistrim condition requiring roll trim to the left.
AIL→	Mistrim condition requiring roll trim to the right.
←RUD	Mistrim condition requiring rudder trim to the left.
RUD→	Mistrim condition requiring rudder trim to the right.
MAXSPD	Overspeed protection is active.
MINSPD	Underspeed protection is active.
YAW	Yaw damper failure. May be red or yellow.
RB OFF	Rudder bias is manually disabled [2]
RB FAIL	Rudder bias system is inoperative [2]
R ENG	Low power detected on right engine. Rudder bias system is active. [2]
L ENG	Low power detected on left engine. Rudder bias system is active. [2]
EDM	Emergency Descent Mode is active.
EDM	Emergency Descent Mode is inhibited or in override mode.

[1] Annunciation flashes for 5 seconds, then turns off.

[2] GFC 600 twin-engine aircraft only.

GFC 600 ALERTS, ROTORCRAFT	
ANNUNCIATION	DESCRIPTION
PFT	Preflight test failure.
FCS	HFCS failure. May be flashing or solid.
P R Y	Servo failure.
P R Y	Out of detent.
P R Y	Out of detent > 30 seconds. [1]
P R Y	Servo is disengaging. [1]
CPLD	HFCS Flight Director is disengaging. [1]
MAXSPD	Overspeed protection is active.
LOWSPD	Underspeed protection is active.
YAW	Yaw damper failure. May be yellow or red.

[1] Annunciation flashes for 10 seconds, then turns off.

FOR ROTORCRAFT: The selected airspeed bug and control field are not present during overspeed and underspeed protection modes.



Normal IAS Operating Mode

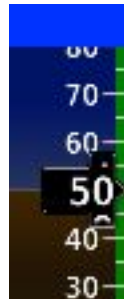

Underspeed Protection Active



Autopilot maintains airspeed at the current bug value. This value annunciates with the active vertical mode.

3.11 Autopilot Preflight Test



WARNING

DO NOT USE A THIRD PARTY AUTOPILOT IF IT DOES NOT DISENGAGE NORMALLY DURING THE PREFLIGHT TEST.

FEATURE LIMITATIONS

- AP DISC availability is dependent upon unit configuration

If the system detects a malfunction in the AHRS, “ATTITUDE” annunciates on the PFD and the autopilot disconnects. For more information, refer to the autopilot operating instructions.

The GAD 43e uses AHRS attitude output to generate analog signal information for an installed ADI-gyro based autopilot system. Should an error occur within the GAD 43e or AHRS output, the autopilot will disengage. Test the autopilot disconnect before each flight.

TEST THE AUTOPILOT DISCONNECT

1. Power up all avionics. Allow time for self-test completion.
2. Engage autopilot.
3. Select **Test** from the PFD Menu.
4. Tap **AP DISC**.
5. Verify autopilot disconnects.

4 Multi-Function Display

MFD SETUP

4.1	Nearest Airport Criteria	4-3
4.2	MFD Display Size Options	4-4

MAP

4.3	Map Interactions	4-8
4.4	Map Views	4-10
4.5	Map Overlays	4-11
4.6	Map Detail	4-15
4.7	Map Setup	4-16

CHARTS

4.8	Chart Setup	4-32
4.9	Chart Selection	4-34
4.10	Aircraft Position Icon	4-35

ACTIVE FLIGHT PLAN

4.11	Edit Data Fields	4-37
4.12	Collapse All Airways	4-38
4.13	Flight Plan Map Indications	4-39
4.14	VNAV Guidance Indications	4-42

WAYPOINTS

4.15	Waypoint Information	4-45
4.16	Waypoint Selection	4-48

SIRIUSXM AUDIO ENTERTAINMENT

4.17	SiriusXM Audio Activation	4-51
4.18	Browse Music Channels	4-51

EXTERNAL VIDEO

4.19	SD Video Setup	4-54
------	----------------------	------

Multi-Function Display

Menu selections vary based on features and optional equipment installed with Garmin avionics.



- Overlays
- Map View
- Map Setup
- Map Detail



- Mode
- Test
- Motion Vector [1]
- Vector Duration [1]
- Altitude Filter
- TCAS II [5]



- View
- Layers
- Layers
- Layers
- (H)Terrain-FLTA
- TAWS [5]



- Selection
- Color
- Streaming
- Type



- Edit Data Fields
- Collapse All Airways



- SiriusXM [1]
- FIS-B WX [1]
- Connex WX [1]
- Stormscope [1]
- Radar [1]



- Airport
- Intersection
- VOR
- VRP
- NDB



- Status



- Fuel Computer
- Engine & Flight Hours
- Engine Advisories
- Lean



- Emergency Descent



- System Status
 - Database SYNC
 - Chart Streaming
 - Update
- External LRUs [2]
- Setup
 - Date/Time
 - Nearest Airport Criteria
 - Startup Page Selection
 - WX Shortcut
 - Click Volume
- Units
- Backlight
- Crew Profile
- Flight Stream [4]
- Logs
 - Aircraft Log
 - Exceedances [1]
 - Export Data Log



- Source (1 – 4) [3]

[1] Dependent upon unit configuration

[2] Available status screens dependent upon configured LRUs

[3] SD/HD designations determined at configuration

[4] Requires Flight Stream 510 wireless datacard

[5] Optional

MFD Setup

MFD SYSTEM SELECTIONS	
System Status	<ul style="list-style-type: none"> • View unit, software, and database information • Check standby database availability • Access Database SYNC, Chart Streaming, and manual database update functions
External LRUs	<ul style="list-style-type: none"> • Check status of all configured LRUs
Setup	<ul style="list-style-type: none"> • Select the MFD startup page and visibility • Set nearest airport criteria • Set the clock and click volume • Create Weather page shortcut
Units	<p>Specify units of measure for displayed data. Selections synchronize across all configured GDUs. Certain LRUs may contain unit settings independent of the TXi system.</p> <ul style="list-style-type: none"> • Distance • Altitude • Temperature • NAV Angle
Backlight	<ul style="list-style-type: none"> • Adjust display brightness
Crew Profile	<ul style="list-style-type: none"> • Access crew profile management function
Flight Stream	<ul style="list-style-type: none"> • Access Bluetooth Setup and Wi-Fi Setup menus
Aircraft Log	<ul style="list-style-type: none"> • View engine and airframe cycle counters
Exceedances	<ul style="list-style-type: none"> • View and acknowledge exceedance advisories • Availability dependent upon unit configuration
Export Data Log	<ul style="list-style-type: none"> • Save logged data to SD card

4.1 Nearest Airport Criteria

Filtering criteria includes settings for minimum runway length and hard or soft runway surface options. Selections determine which airports are available when using the nearest airport search feature.

RUNWAY SURFACE	MINIMUM RUNWAY LENGTH
<p>Aircraft runway surface selection:</p> <ul style="list-style-type: none"> • Any • Hard/Soft • Hard Only • Water 	<p>Specify the shortest distance required for takeoff and landing. In the AFM/POH, this is typically the distance given for sea level and the coldest air temperature.</p>

4.2 MFD Display Size Options

4.2.1 MFD 40/60% Resize

FEATURE LIMITATIONS

- GDU 1060 PFD/MFD and MFD/MFD units only
- Availability dependent upon configuration
- Accessible from the MFD Home page only



The **Resize** key allows you to change the size of the MFD. This option resides on the MFD Home page.

Tapping the key once expands the MFD from its default 40% screen area to 60%. Tapping it again returns the MFD to 40% area.

4.2.2 MFD Full/Split Screen

FEATURE LIMITATIONS

- GDU 1060 MFD/MFD and MFD/MFD/EIS units only



Tapping **Full** changes the size of one MFD to fill both MFD display areas.



Tapping **Split** restores the dual MFD view.

Map



To increase situational awareness, the Map page depicts the aircraft's current position relative to land, aeronautical, weather, and traffic information.

FEATURE REQUIREMENTS

- Active GPS source (aircraft position symbol)
- FIS-B, Iridium transceiver, or SiriusXM receiver (weather data)
- GDL 69, GDL 88, GNX 375, GTX 345, or GSR 56, with appropriate weather service subscription (NEXRAD overlay)
- Active weather subscription (Connex and SiriusXM only)
- Valid charts database (ChartView, FliteCharts) with effective database cycle, and aircraft to be airborne
- GWX 68, GWX 70, or GWX 75 (airborne weather radar overlay)
- WX-series Stormscope receiver (lightning data)
- TIS/TAS/TCAS I/TCAS II traffic device (traffic data)

FEATURE LIMITATIONS

- Onboard weather radar not available for GDU 700() EIS/MFD configuration



Default Map Elements

MAP OBJECT	FUNCTION
Aircraft Symbol	<p>Depicts current aircraft position and orientation.</p> <ul style="list-style-type: none"> • Tip represents actual aircraft location • Symbol type is dependent upon configuration • Absent if GPS source is not available
Basemap	<p>Presents a graphical depiction of land and water data. Basemap is always depicted.</p>
Page Orientation Label	<p>Three orientations:</p> <ol style="list-style-type: none"> 1. North Up orients map to north. 2. Heading Up orients map to current aircraft heading. 3. Track Up orients map to current aircraft GPS track.
North Indicator	<p>Indicates True north. Tap to orient the map North Up.</p>
Map Range Indicator	<p>Displays current map range in upper left quadrant of range ring (i.e., distance from the aircraft to range ring).</p>
NAV Range Ring	<p>Displays current direction of travel on a rotating compass. Orientation: Magnetic north</p>
Map Overlay Icons	<p>Indicates status of overlays at the current map range. Includes: lightning, obstacles, power lines, precipitation, Stormscope, terrain, and traffic</p>
Menu Key	<p>Accesses map overlay controls and pilot selectable settings.</p>

FEATURE LABELS

To maintain readability, map feature labels remain uniform at all zoom levels.

TRAFFIC UNITS

System Units page selections do not affect the display of traffic on the Map page.



If altitude system units are set to meters, the traffic overlay icon will change, serving as a reminder that traffic altitude values remain in feet.

LAND AND WATER DEPICTIONS

Land and water data are for general reference only. Data accuracy is not suitable for use as a primary navigation source. The information is intended to supplement and not replace official government charts and notices.

DATA DRAWING ORDER

The electronic map draws data in order of priority, from highest (1) to lowest (39), with higher priority features drawn atop those of lower priority.

LEVEL	FEATURE
1	Traffic
2	Ownship
3	Flight Plan
4	TAWS FLTA
5	Fuel Range Ring
6	Weather Radar
7	Charts
8	Stormscope
9	Point Obstacles
10	Line Obstacles
11	TFR
12	Freezing Level
13	Cell Movement
14	Lightning
15	METAR
16	Winds Aloft
17	SIGMET
18	AIRMET
19	Cyclone
20	County Warning

LEVEL	FEATURE
21	PIREP
22	AIREP
23	City Forecast
24	Surface Conditions
25	Airspace
26	Waypoints
27	Airways
28	Reference Grid
29	Turbulence
30	Icing
31	Radar Coverage
32	Echo Tops
33	NEXRAD
34	Cloud Tops
35	SafeTaxi
36	Runways
37	Terrain
38	Basemap
39	Topo

4.3 Map Interactions

Typical map interactions include zoom, pan, and object selection.

PAN & ZOOM

Panning allows movement of the map in any direction without change to the current zoom setting. Zooming adjusts the current magnification level between pilot specified range parameters.

OBJECT SELECTION

Tapping any object or location on the map displays a map pointer and an information banner.

MAP POINTER

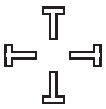

This symbol indicates point of contact on the map. A gray circle highlights any selected waypoint or obstacle.

INFO BANNER

Available information and controls are dependent upon object or location type and proximity to other objects.



Selecting an airport icon displays the airport's highest field elevation.

Active Overlay Icons (shifted up)

Waypoint Info Key

Info Banner Features

- Pan mode annunciation
- Bearing, distance, and estimated time en route from current aircraft position to map pointer
- Location elevation
- **Next** key for stacked objects
- Maximum altitude AGL and MSL for obstacles
- Information page access key for the selected waypoint, airspace, airport, airport surface hot spot, or TFR

STACKED OBJECTS



To move the selector through each object in proximity of the map pointer, select an object and tap **Next**.



Overlapping objects may be difficult to identify at a given zoom level.

AIRSPACE INFO

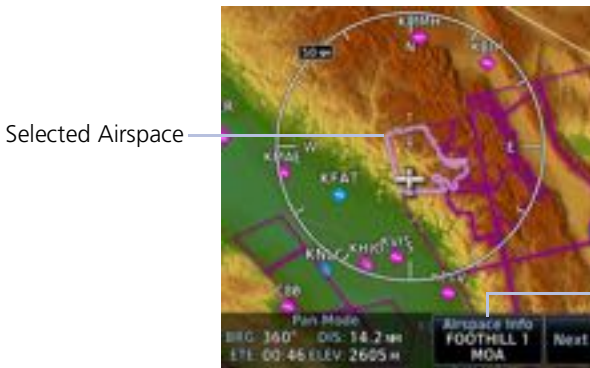

When selected, active airspace boundaries change color.

Airspace Info Page Features

Airspace info pages have the same basic layout as waypoint info pages. The upper portion contains specific data of the selected airspace. The remainder of the page displays the active airspace boundary and a map of the surrounding area. Data includes:

- Airspace status and type
- ATC entity responsible for the airspace, if applicable
- Floor and ceiling altitudes

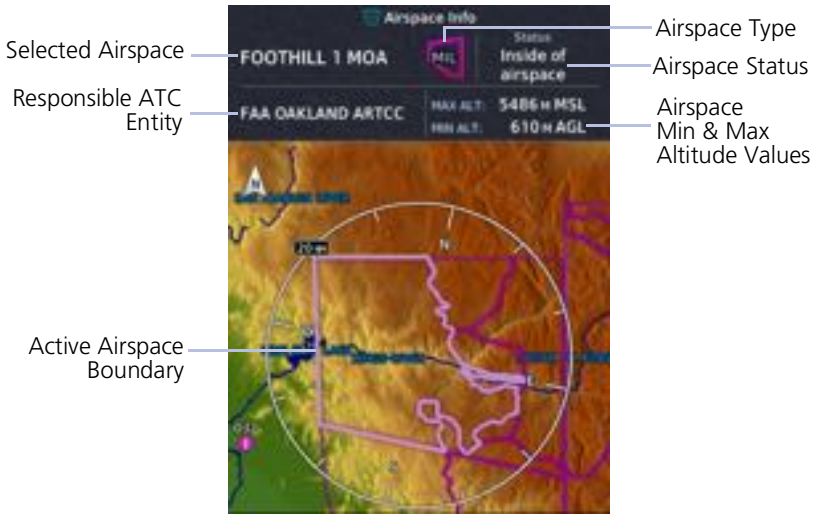

4.4 Map Views



The **Map View** key in the Map Menu may be used to select a user-configurable map view.



Three different map views may be individually configured. All settings configured in the map menu and map setup menu are saved.

Views may be reconfigured at any time. Any changes to a view configuration are immediately shown on any MFD in the system using that view.

Selecting any view loads previously saved view settings.

Tap the **Customize** key to change a view name or reset both the name and all menu settings to their default values.

4.5 Map Overlays

Overlay Selections

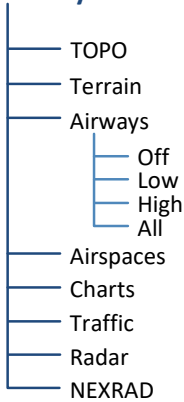

Various map overlay selections may be configured. The following overlay functions are mutually exclusive. Enabling one automatically disables the other.

- NEXRAD, terrain, and weather radar overlays
- Stormscope and SXM lightning
- Cloud tops and echo tops
- Charts and SafeTaxi

4.5.1 Overlay Controls



Control keys enable the specified overlay function only and do not activate interfaced equipment. Overlay keys remain active even in the absence of required data.

TOPO



- Overlays topographical data and ground elevation scale
- Depictions are similar to a VFR sectional

TERRAIN

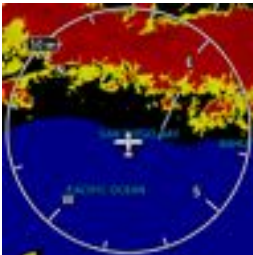

- Overlays terrain map data
- Color shading depicts terrain elevation relative to the aircraft's altitude

AIRWAYS



- Overlays the selected airway type(s) with identifier labels
- Options include: low, high, all, or off (none)
- High altitude airways are green, low altitude airways are gray

AIRSPACES



- Overlays airspace boundaries with altitude labels

CHARTS



- Overlays geo-referenced chart information
- Approach chart for the active flight plan in the navigator
- Airport surface chart if nearest airport is within 200 nm and no approach is active
- Arrival and departure chart overlays are not available
- Depicts planview area only; excludes inset information (e.g., missed approach procedure view)
- Optional

TRAFFIC



- Overlays traffic information
- Filter selection on Traffic page determines altitude range
- Optional

RADAR

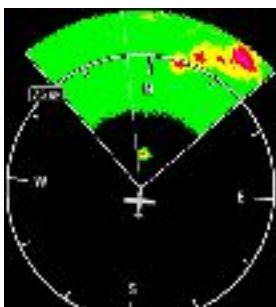

- Overlays airborne weather radar information
- Depictions are identical to those on Weather Radar page
- Excludes WATCH shading
- Optional

NEXRAD



- Overlays datalink precipitation weather information, including product age
- Optional

4.5.2 Overlay Status Icons

Icons indicate which overlays are present at the current map range. A crossed out icon means the overlay is active, but data is unavailable due to a failure, test, or standby condition (where relevant).

The absence of an overlay icon means one of two possible conditions:

1. Overlay not present at the current detail level or zoom setting.
2. Overlay control is off.

	Obstacle		Power Line
	Stormscope		Traffic
	Terrain		Data not available

4.6 Map Detail



Select the level of detail on the map. Changes to the map detail level take effect immediately.

FEATURE	MAP DETAIL LEVEL			
	FULL	HIGH	MED.	LOW
Small Cities	•			
Medium Cities	•			
Large Cities	•			
Freeways	•			
Highways	•			
Roads	•			
Railroads	•			
Basemap Labels	•			
VORs	•	•		
NDBs	•	•		
Line Obstacles	•	•		
Point Obstacles	•	•		
Airspaces that are not prohibited or restricted	•	•		
Waypoints	•	•	•	
SafeTaxi	•	•	•	
Prohibited Airspaces	•	•	•	

4.7 Map Setup

Map Setup

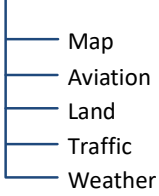

Overlay data controls are located in the Map Setup menu. Changes to an overlay setting take effect immediately. Selections are organized into five groups.

RESTORE DEFAULTS

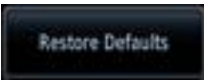

Located in the bottom of each list. This key restores all original factory settings for the active group tab.

4.7.1 Map Selections

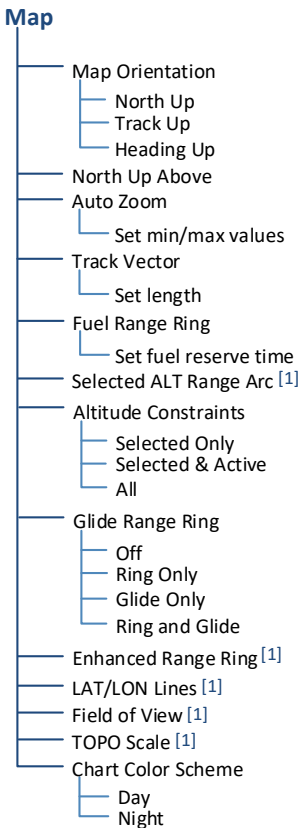

[1] On/off functionality only.

All Map tab selections provide on/off and range setting options unless otherwise noted.

Shared Map Settings

Changes to the following map settings also take effect on the configured datalink weather app(s). You may adjust these settings from the appropriate Map Setup tab.

- North Up Above range setting and LAT/LON Lines (Map tab)
- Runway Extensions and waypoint display range settings (Aviation tab)
- Road Detail, City Detail, State/Province Borders, and River/Lake Detail (Land tab)

Map Orientation	<ul style="list-style-type: none"> • Specifies map display orientation • Label above North indicator shows current orientation
North Up Above	<ul style="list-style-type: none"> • Specifies range at which the map orientation changes to North Up

<p>Auto Zoom</p>	<ul style="list-style-type: none"> • Automatically adjusts page to display the next waypoint in flight plan at the closest possible map range • Presents SafeTaxi data while aircraft is on ground • Automatic functionality is overridden during manual zoom interactions. It resumes when: <ul style="list-style-type: none"> •Another waypoint is in sequence •Aircraft transitions from on ground to airborne •Auto zoom range matches manual override range • Set minimum and maximum values to best meet operational needs
<p>Track Vector</p>	<ul style="list-style-type: none"> • Indicates current ground track • End of arrow represents aircraft position at the specified time interval
<p>Fuel Range Ring</p>	<ul style="list-style-type: none"> • Estimates the remaining range at the current fuel consumption rate and ground speed [1] • Calculations are based on the pilot specified fuel quantity in the fuel computer • Dashed green circle indicates selected range to reserve fuel • Solid yellow circle indicates total endurance range
<p>Selected ALT Range Arc</p>	<ul style="list-style-type: none"> • Represents location at which the aircraft is expected to reach selected altitude [2]
<p>Altitude Constraints</p>	<ul style="list-style-type: none"> • Displays altitude constraint labels within the flight plan
<p>Glide Range Ring</p>	<ul style="list-style-type: none"> • Identifies map region within estimated gliding distance and/or best glide airport • Options: Ring Only, Glide Only, Ring and Glide
<p>Enhanced Range Ring</p>	<ul style="list-style-type: none"> • Provides a more precise indication of distance between the aircraft and map objects • Fixed range value at half the distance of NAV range ring
<p>LAT/LON Lines</p>	<ul style="list-style-type: none"> • Displays latitude and longitude lines
<p>Field of View</p>	<ul style="list-style-type: none"> • Depicts lateral terrain view presented in SVT [3] • Synthetic Terrain function on PFD must be active for indication to display
<p>TOPO Scale</p>	<ul style="list-style-type: none"> • Displays a topographical elevation scale
<p>Chart Color Scheme</p>	<ul style="list-style-type: none"> • Changes chart overlay color for day or night view

[1] Requires EIS.

[2] Systems with at least one PFD.

[3] GDU 1060 only.

Fuel Range Ring

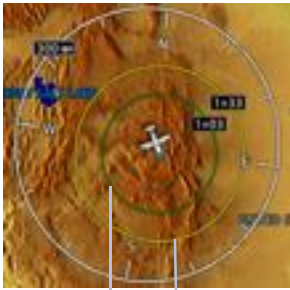

Range to Reserve Fuel Range to Empty

Enhanced Range Ring



NAV Range Ring Enhanced Range Ring

Field of View (GDU 1060 Only)



TOPO Scale

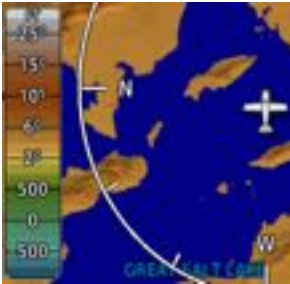

Selected ALT Range Arc



Track Vector



When choosing map scales:

- Consider which map scales or zoom levels to use to achieve the desired level of detail and map information.
- Generally, use smaller map scales or zoom levels in and around terminal areas and whenever precise navigation is required (e.g., airway or radial intercepts).
- During cruise flight, map scale settings often increase to balance navigation, situational awareness, and decision making.

Map Orientation sets the map page to either North Up, Track Up, or Heading Up. North Up is useful when zoomed out to view the entire route or a frontal system on a NEXRAD display.

Using the North Up Above feature causes the screen to switch at certain zoom levels. This is useful as a shortcut to quickly increase situational awareness.

Track vector length options display as a dashed line and arrow extending from the aircraft icon, showing current track and distance the aircraft will travel in the selected time.

If the track vector is placed over a point on the map, and no data is entered into the system, the GDU indicates a wind-corrected GPS track to that point. This is useful for intercepting airways and radials, making small but positive lateral corrections during approaches, and in setting up for arrivals in the terminal area.

GLIDE RANGE RING

FIXED WING AIRCRAFT ONLY

FEATURE REQUIREMENTS

- GTN Xi series navigator (host) configured for Glide Range Ring
- Datalink winds or compatible PFD (Glide Range Ring wind compensation)
- For best glide performance, the aircraft must be configured in accordance with POH guidance

FEATURE LIMITATIONS

Glide Range Ring is a function of the GTN Xi series navigator. GDU does not calculate glide range, nor does it determine best glide airports; it only displays this data when received from GTN Xi. For more about this feature, consult *GTN Xi Pilot's Guide*.



Identifies map region and features within gliding distance. A cyan border indicates where the glide path reaches 50 ft above terrain.

Calculations are performed by the host GTN Xi navigator.

The Glide Range Ring is an estimate based on the best glide speed and glide ratio published for the aircraft. For more information, consult the POH.

This overlay receives wind information from the integrated ADAHRS if present. It does not require an ADAHRS unit for operation.

Glide Range Ring Options

- Off
- Ring Only
- Glide Only
- Ring and Glide

The Glide Range Ring depicts the estimated glide range down to 50 ft AGL. It does not show beyond 50 ft AGL where the aircraft reaches the ground.

Data updates occur approximately every 10 seconds.

Ring Only



Glide Range Ring

Ring and Glide



Best Glide Airport Indicator

Enable Glide Range Ring to stay aware of all airports within gliding distance. This is extremely helpful should you experience engine failure.

Glide Only



Best Glide Airport Indicator

Cyan arrows point toward the best glide airport at any given time. Best glide airport selection is based on distance from current location, runway length, and weather (if available). Airports beyond the range ring are not considered for routing.

To enable, tap **Glide Range Ring** and select **Ring and Glide** or **Glide Only**.





“No Wind Data” Indicator

This indication appears when FMS winds and datalink winds aloft are either unavailable or invalid.

The Glide Range Ring does not adjust to account for current winds when the indicator is present.

No Wind Data

4.7.2 Aviation Selections

Aviation

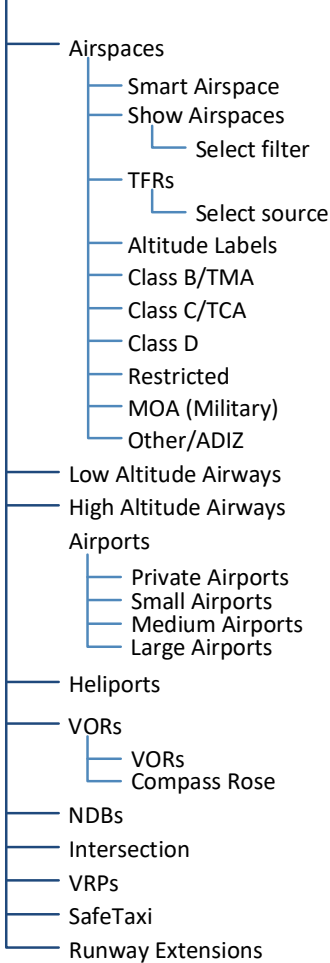

Setup options allow the customization of aeronautical information.

- Filter airspace data according to altitude
- Select a TFR source
- Specify airway types and range values
- Customize the display of SafeTaxi and waypoint data
- Display runway extensions for a destination airport

With the exception of TFRs, all Aviation tab selections provide on/off and range setting options.

The runway feature extends the runway’s centerline out 5 NM from the runway threshold. This is useful when setting up for a visual approach, especially at airports with parallel runways or low visibility.

AVIATION DATA SYMBOLS

	Non-towered, non-serviced airport ^[1]		Non-towered, serviced airport ^[1]
	Towered, non-serviced airport ^[1]		Towered, serviced airport ^[1]
	Soft surface, non-serviced airport		Soft surface, serviced airport
	Restricted (private) airport		Unknown airport
	Heliport		ILS/DME or DME only
	Intersection		LOM
	NDB		TACAN
	VOR		VOR/DME
	VORTAC		VRP
	User Airport		User Waypoint
	Runway extension		ATK

[1] Symbol depicts orientation of longest runway.

4.7.3 Smart Airspace

Garmin’s Smart Airspace feature automatically de-emphasizes non-pertinent airspace away from the aircraft’s current altitude. An airspace boundary turns gray when its vertical proximity to the aircraft is >1,000 ft. This range increases linearly to 2,000 ft as the aircraft ascends to 10,000 ft.

SMART AIRSPACE CRITERIA	
AIRCRAFT ALTITUDE	AIRSPACE PROXIMITY TO AIRCRAFT [1]
Sea level	>1,000 ft
>10,000 ft	2,000 ft

[1]Vertical distance above and below aircraft altitude.



AIRSPACE DATA SYMBOLS

	Class B Altitude Label (ceiling/floor)		Class C/TCA
	Class C Altitude Label (ceiling/floor)		Class D
	Class D Altitude Label (ceiling only)		Restricted
	TFR		MOA
	Class B/TMA		Other/ADIZ

4.7.4 SafeTaxi

During flight, SafeTaxi database is mutually exclusive with chart databases. SafeTaxi and hot spot data display only when the Charts overlay is off.

SafeTaxi Features

- Airport diagram overlay that includes hot spot information
- Aircraft position relative to taxiways, runways, and airport landmarks
- Automatically overrides Charts overlay function during ground operations
- Pilot selectable range options

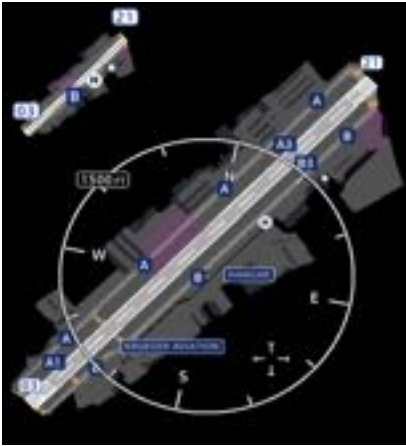

SafeTaxi provides greater map detail and higher image resolution at lower zoom levels.

Feature labels denote:

- Runways
- Taxiways
- Airport landmarks

SAFETAXI DATA SYMBOLS



Runway



Taxiway



Helipad



Construction Area



Airport Beacon



Unpaved Parking

HOT SPOTS

SafeTaxi hot spots identify locations on an airport surface where positional confusion or runway incursions are likely to occur. These known problem areas require heightened attention by pilots.



The following airport features may be deemed hot spots by aviation authorities.

- Intersecting taxiways and runways
- Complex ramp areas
- Directional limitations
- Limited wing-tip clearance
- Overflight risk



Selecting the border of a hot spot displays a brief summary of the indicated hazard and an information key.



Accessing this key provides additional location and potential hazard information. Numbering corresponds to a list on the airport diagram.



Location Info

Overlay Icons (not hidden)

CONSTRUCTION SPOTS



There are no expanded detail keys or notes associated with construction areas.

Construction Area Border

4.7.5 Land Selections

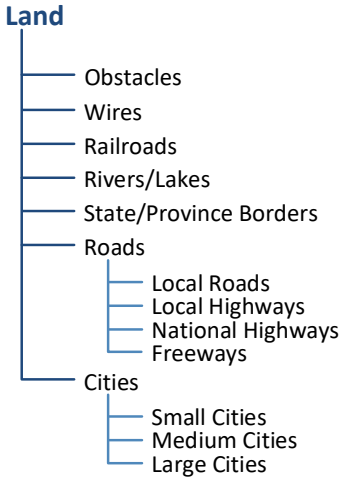

Selections include on/off and range setting options for all land features.

LAND DATA SYMBOLS



Railroad



National Highway



River/Lake



Freeway



State/Province Border



Small City



Local Road



Medium City



Local Highway



Large City

4.7.6 Traffic Selections



Filter traffic data according to type. Other selections include on/off and range setting options.

4.7.7 Weather Selections

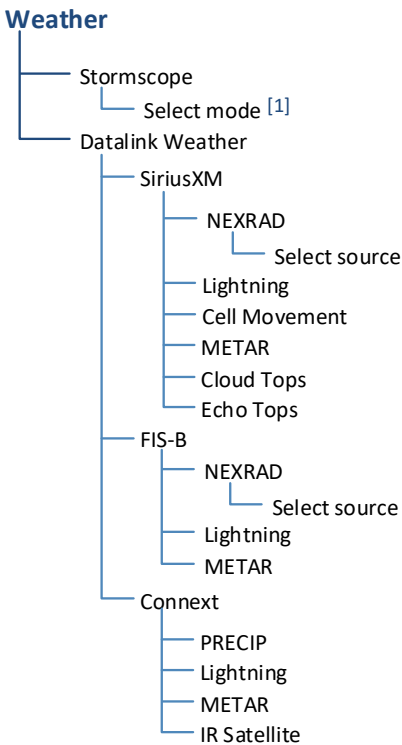

Setup options are available for all active weather services.

- Alternate between lightning display modes (Stormscope only)
- Specify a datalink weather source
- Toggle individual weather products on/off

[1] Mode selection affects setting on dedicated weather page.

Charts



The Charts page provides terminal procedures and airport surface diagrams.

FEATURE REQUIREMENTS

- A current and valid chart database

FEATURE LIMITATIONS

- Geo-referencing is not available for some arrival and departure charts
- FliteCharts and ChartView databases are optional and mutually exclusive

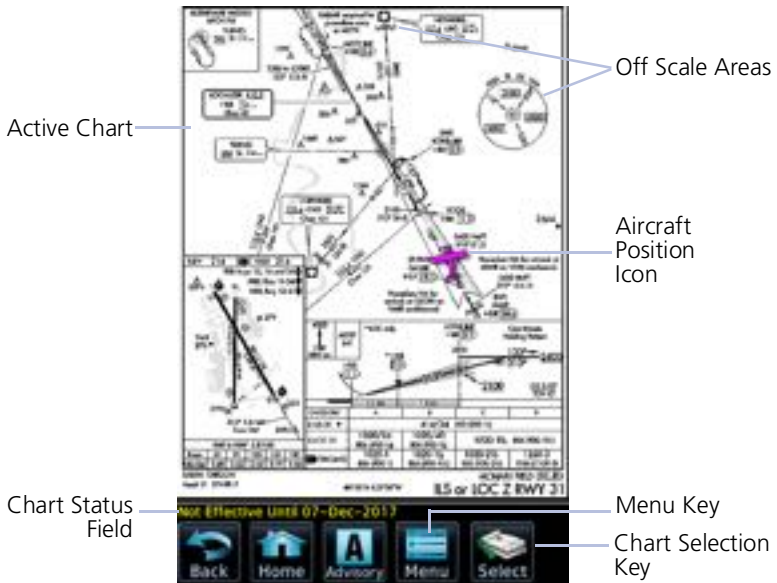

Charts Page

CHART STATUS

Active chart status displays in the lower left corner of the Charts page.

Getting Newer Charts

Charts are in the process up updating.

Charts Changed

Charts are up to date.

Expired 28-Apr-2016

Database is out of date.

Not Effective Until 31-Mar-2016

Database is installed before it is current.

4.8 Chart Setup

Chart setup selections reside in the Charts menu.

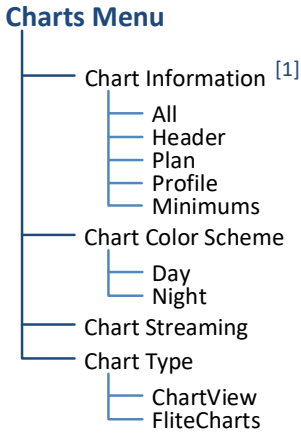

[1] ChartView only.

<p>Chart Information</p>	<p>Displays individual sections of a chart in the ChartView database only. Options include:</p> <ul style="list-style-type: none"> • All • Header • Planview • Profile • Minimums
<p>Chart Color Scheme</p>	<p>Toggles chart color scheme between day and night modes.</p> <ul style="list-style-type: none"> • Day mode displays black on white background • Night mode displays inverse white on black background
<p>Chart Streaming</p>	<ul style="list-style-type: none"> • Enables automatic streaming of individual charts to the GDU during database synchronization • Streams from the newest chart database • Charts from the previously loaded database remain available for display • Toggling this function off does not affect Database SYNC • No restart required
<p>Chart Type</p>	<ul style="list-style-type: none"> • Toggles chart database type between FliteCharts and ChartView • Selections must be made on the ground • Restart required for changes to take effect

CHARTVIEW INFORMATION SECTIONS

Header

Planview

Profile

Minimums

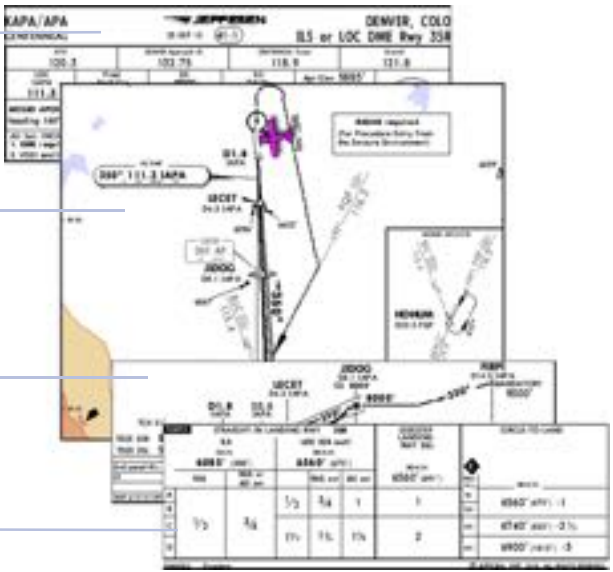

4.9 Chart Selection

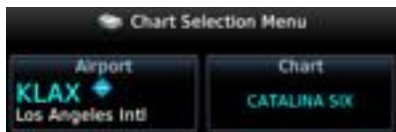

To open a menu, tap **Select**. Enter an airport identifier and choose from the available chart types.

CHART TYPES

Information	Airport surface charts, alternate minimums, rate of climb and descent tables, inoperative components or visual aids tables, hot spots, land and hold-short operations, and other destination specific flight data.
Departure	Departure route descriptions, including takeoff minimums and obstacle notes.
Arrival	Arrival procedure instructions. Arrival charts are listed in alphabetical order.
Approach	All approach charts associated with the selected airport. Charts are listed according to level of precision and approach type. Runways are listed in numerical order.

AUTOMATIC CHART SELECTION

Automatic chart selection occurs every time the Charts page is opened. The type of chart selected is determined by aircraft status and content from the active flight plan. This function does not override manual chart selections unless a change occurs during one of the following conditions.

CONDITION	CHART DISPLAY DEFAULT
No flight plan or destination airport is present.	Nearest airport diagram.
Aircraft is on the ground.	Nearest airport diagram (regardless of flight plan).
Flight plan is present, but approach is not loaded.	Airport surface chart for previous airport in flight plan.
Approach is loaded in the selected GPS navigator.	Applicable approach chart.
No charts are available for a selected airport.	"Chart not available for [airport ID]."

4.10 Aircraft Position Icon

FEATURE REQUIREMENTS

- Aircraft position is fully within chart boundaries
- FliteCharts or ChartView is active (airborne maneuvers only)
- SafeTaxi is active (ground maneuvers only)

FEATURE LIMITATIONS

- SIDs and STARs do not support the display of aircraft position
- Not available for arrival and departure charts
- Displays only within the planview area of geo-referenced approach charts

Aircraft position displays on airport diagrams and approach charts when the current position is known.

POSITION UNAVAILABLE INDICATION



A fault icon displays in the lower right-hand page corner when:

- Aircraft position data is not available
- Backup GPS is in use
- Selected chart does not contain geo-referenced data
- Selected chart layer is not All or Planview

OFF SCALE AREAS

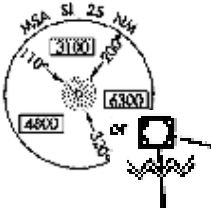

Some charts contain supplemental information within the planview. These areas are considered off scale as they are not geographically accurate.

Aircraft position depictions in off scale areas should be judged relative to the geo-referenced information within the planview only.

Active Flight Plan



Current flight plan information received from a Garmin navigator displays as a scrolling list on the Active Flight Plan page.

FEATURE REQUIREMENTS

- External GPS navigator
- Configured GTN, v6.50 or later (VNAV constraint data)
- Active flight plan

FEATURE LIMITATIONS

- Create, edit, and delete functionality not available on GDU. Any alterations to a flight plan must be performed using the external navigator
- Displays up to 100 waypoints for an active flight plan

The screenshot shows the 'Active Flight Plan' page with the following callouts:

- Waypoint Identifier Column:** Points to the first column of the flight plan list.
- Procedure Header:** Points to the 'Approach - KLAX ILS 07L' header.
- Active Leg Indicator:** Points to the pink arrow icon next to the 'MERMA' waypoint.
- Current Waypoint:** Points to the 'MERMA' waypoint row.
- Waypoint Type Icon:** Points to the 'MERMA' icon.
- Active VNAV Constraint Data:** Points to the 'MERMA 1320-4' constraint.
- Selectable Data Field Columns:** Points to the columns for altitude, time, and distance.
- Airport Info Key:** Points to the 'APT Info' button.
- Leg Data:** Points to the '1320-4 0:00 3.0mi' data for the active leg.
- Selecting a waypoint identifier opens the associated info page:** Points to the 'MERMA' identifier.

Waypoint	Altitude	Time	Distance
MERMA (Active)	1320-4	0:00	3.0mi
DITDA	1320-4	0:00	4.0mi
TEKIL	1320-4	0:00	5.0mi
TURISA	1320-4	0:00	6.0mi
RW07L	---	---	5.0mi

Active Flight Plan Page

AIRPORT INFO



For convenience, airport information is directly accessible from the procedure header. This includes airports specified in active approaches, arrivals, and departures.

ACTIVE VNAV CONSTRAINT WINDOW

VNAV Constraint Data

ALT - Altitude Constraints
 VS TGT - Vertical Speed Target
 VS REQ - Vertical Speed Required
 V DEV - Vertical Deviation
 TOD/BOD - Top/Bottom of Descent
 FPA - Flight Path Angle

VS TGT and FPA are pilot-specified values received from the GTN. All other constraint values are based on VNAV calculations.

The TOD field may change to display BOD once the top of descent value counts down to zero.

4.11 Edit Data Fields



To select a flight plan data column, tap **Edit Data Fields**. Columns are arranged in numerical order (1 - 3).

To restore columns to default display settings, tap **Restore Defaults**.

Data Field Selections

ALT - Altitude Constraint
 CUM - Cumulative Distance
 DIS - Distance
 DTK - Desired Track
 ETA - Est. Time of Arrival
 ETE - Est. Time En Route
 FPA - Flight Path Angle

Selections are identical for each column.

By default, flight plan information fields display:

Column 1: DTK

Column 2: DIS

Column 3: CUM

4.12 Collapse All Airways

Airways automatically display as flight plan legs. A single airway may contain numerous legs. Airways without an active leg collapse for simplification. This does not affect airway legs shown on the external navigator(s).

Airway Indication

Expanded Airway Detail

Airway Collapsed Indication

Exit Waypoint

Airway - V03 SAF			
MASSA	177°	6.0 nm	988 ft
LYSSA	177°	8.0 nm	996 ft
ZOTOS	177°	7.6 nm	1003 ft
TAS Taos	177°	23.0 nm	1026 ft

Airway - V03 SAF (collapsed)			
SAF		109 nm	1091 ft
Santa Fe			

All airways begin with an indicator field and end with an exit identifier.

To hide all waypoints along an airway, but not the airway's exit waypoint, tap **Collapse All Airways**.

4.13 Flight Plan Map Indications

FLIGHT PLAN LEG STATUS

LEG STATUS	COLOR
Active	Magenta
Next & Future	White
Past or Inactive	Gray

Active, next, and previous flight plan legs overlay on the Map page and HSI Map. These indications are display only.



ALONG TRACK WAYPOINT IDENTIFIER LABELS



The along track waypoint (ATK) icon represents a temporary lateral position (or checkpoint) relative to an existing waypoint in the flight plan.

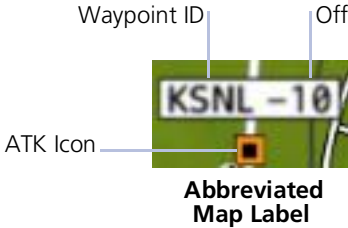

Identifier labels on the Map page denote the adjacent waypoint's ID and offset distance from the specified ATK.

Selecting an ATK displays its bearing and distance in the info banner.

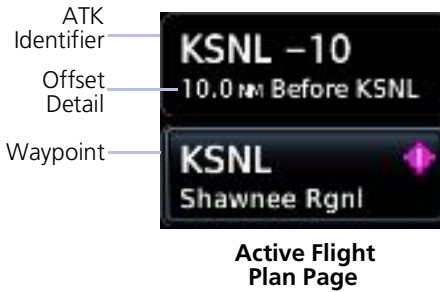

Unlike waypoints, ATKs indicate a temporary route fix in the flight plan. The GDU receives this data from the navigator, not a database.

Enabling the altitude constraint function in the Map Setup menu adds a VNAV altitude reference to the flight plan. The ATK serves as a lateral checkpoint when the feature is off.

ALTITUDE CONSTRAINT LABELS



Altitude constraint data display as text labels on the Map page. Units are typically feet or meters depending on current altitude setting in the Units page. They display as flight level altitudes if specified as such on the navigator.

If excessive labels are cluttering the map, this feature may be turned off.

USER AIRPORT ICON



A dedicated icon indicates user created airport waypoints received from the external GPS navigator.



User airport indications display on both the Active Flight Plan and Map pages.

Identifier Type Icon

Selected User Airport



When selected, the user identifier annunciates in the info banner.

User Identifier

4.14 VNAV Guidance Indications



WARNING

DO NOT RELY SOLELY ON VNAV GUIDANCE WHEN NAVIGATING HORIZONTALLY AND VERTICALLY AROUND USER-DEFINED AIRPORTS. IT IS THE PILOT'S RESPONSIBILITY TO ENSURE SEPARATION FROM TERRAIN AND OBSTACLES DURING AN APPROACH TO A USER-DEFINED AIRPORT.

ALTITUDE CONSTRAINT INDICATIONS

COLOR DEFINITIONS	
White	Altitude is for reference only.
Cyan	GTN honors the constraint for vertical guidance when the VNAV function is active.

When the VNAV function is active on GTN, altitudes may be accompanied by one or two altitude restriction bars. The position of the value (above or below the bar, or between two bars) denotes the required aircraft altitude relative to that constraint.

Dual values annunciate when the aircraft needs to cross between two altitudes.

Constraint values display in MSL or flight level (FL). Constraints at airports may be specified as MSL or AGL.

Examples:

Cross at or Above 5,000 ft

5000 FT

Cross at or Below 5,000 ft

5000 FT

Cross at 5,000 ft

5000 FT

Cross Between 5,000 ft and 6,000 ft

**6000 FT
5000 FT**

ALTITUDE TYPES



Database Constraint

Altitude is retrieved from the navigation database and designated for use in determining vertical guidance.



Pilot-specified Constraint

Pencil icon indicates manual designation or manual data entry.



Invalid Altitude Constraint

GTN cannot use the altitude to determine vertical guidance.

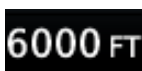

Estimated Crossing Altitude

For reference only.

System calculated estimate of aircraft altitude as it passes over the navigation point. Absence of bar(s) indicates it is not a potential constraint.



Published Reference Altitude

For reference only.

Altitude is retrieved from the navigation database, but not for use in determining vertical guidance. Bar above and/or below the value indicates constraint type.

Altitude Constraint Data Priority

GDU receives constraint data from the GTN and displays it in the ALT column of the active flight plan.

GTN prioritizes the data for each navigation point in the following order:

1. GTN honored constraints (includes invalid constraints)
2. Reference-only estimated crossing altitudes
3. Published reference altitudes
4. Empty (no altitude data)

INVALID ALTITUDE CONSTRAINTS

An altitude constraint is invalid if:

- Meeting the constraint requires the aircraft to climb
- Meeting the constraint requires the aircraft to exceed the maximum flight path angle (6° downward) or maximum vertical speed (-4,000 fpm)
- It results in a TOD behind the aircraft's current position
- It is within a leg type that does not support altitude constraints
- It is added to a waypoint past the FAF

Waypoints



Dedicated information pages provide waypoint search functions and details not available on the Map page.

4.15 Waypoint Information

FEATURE REQUIREMENTS

- Viewing NOTAMs requires ChartView or FIS-B

FEATURE LIMITATIONS

- 2-D maps provide zoom functionality only (panning is not available)
- FIS-B transmits distant and FDC NOTAMs within 100 nm of radio station position



Waypoints are organized into five groups:

1. Airports
2. Intersection
3. VOR
4. VRP
5. NDB

The Airport page is a great place to start while performing an approach brief, checking weather, or considering a diversion.

Multi-Function Display

Intersection, VOR, VRP, and NDB information pages have a uniform layout.



Intersection Page

COMMON PAGE FEATURES

All waypoint information pages share the following features.

Data fields:

- Distance and bearing from current aircraft position
- Latitude and longitude
- Applicable country and/or region (e.g., "SW USA")
- 2-D map of the surrounding area (Map views display on Preview and Runways tabs of the Airports page)
- Identifier and type icon

Controls:

- **Waypoint Identifier** key with access to multiple search tab

WAYPOINT SPECIFIC PAGE FEATURES

The following features are unique to the corresponding waypoint.

Airport

Selectable tabs:

Info: Airport location, elevation, time zone, airport charts, and fuel availability.



To open the specified airport chart, tap **View Charts**.

Preview: SafeTaxi depiction of airport and surrounding area.

Runway: Identifiers, size, surface type, traffic pattern direction, and PCL frequency.

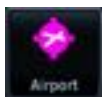

To open a list of available runways, tap **Runways**.

Frequencies: Available communication and localizer frequencies. The "c" symbol denotes frequencies that function as the CTAF. If available, for additional frequency information, tap "**More Information**."

Weather Data: METARs, city forecast, and TAF weather information for an airport.

NOTAMS: Applicable distant and FDC NOTAMs.

Airport Directory: Airport arrival information including local information based on AC-U-KWIK or AOPA data.

Intersection



Data fields:

From NRST VOR: identifier, type icon, bearing, and distance

Very High Frequency Omni-directional Range

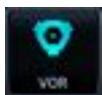

Data fields:

- Frequency
- To NRST APT: identifier, type icon, bearing, and distance
- Station Declination
- VOR Class

Visual Reporting Point



Data fields:

To NRST APT: identifier, type icon, bearing, and distance

Non-Directional Beacon



Data fields:

- Frequency
- To NRST APT: identifier, type icon, bearing, and distance
- Marker Description

4.16 Waypoint Selection



The **WP Identifier** key provides access to different waypoint search options. Enter a specific identifier or select one from the available search tabs.

4.16.1 Waypoint Autofill

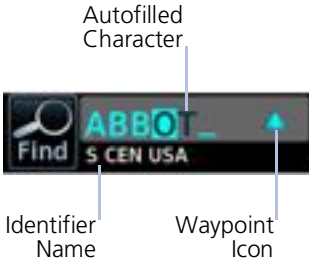

The autofill function assigns alphanumeric values into search entry fields.

Autofill characters are cyan and display from cursor position to the right of the field.

Characters autofill based on the first alphabetical match in the navigation database. Matching entries typically change with the addition of a each typed character. "No matches found" and "Duplicate found" annunciate when applicable.

4.16.2 Search Tabs



The **Find** key provides access to multiple search tabs. Each tab displays a list of identifiers based on specific criteria.



Each entry includes general information about the associated waypoint.

RECENT

Lists up to 20 of the most recently viewed waypoints.

NEAREST

Lists up to 25 waypoints within a 200 nm radius.

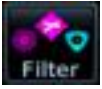

Tap **Filter** and select from the available filter options. Only waypoints belonging to the selected class appear in the list.

To list all classes, select **All**.

FLIGHT PLAN

Lists all waypoints contained in the active flight plan.

SEARCH NAME



Lists all airports, NDBs, and VORs associated with the specified facility name. Tap the key and enter the facility's name.

SEARCH CITY



Lists all airports, NDBs, and VORs found in proximity of the specified city. Tap the key and enter the city's name.

SiriusXM Audio Entertainment



The Music page provides controls for tuning and presetting satellite radio music channels.

FEATURE REQUIREMENTS

- Active SiriusXM Satellite Radio subscription
- Audio Radio and/or Data Radio ID
- Configured GDL 69/69A interface



Music Page

RADIO VOLUME



Directional keys allow volume adjustments.

Mute toggles radio audio output on or off.

4.17 SiriusXM Audio Activation



The GDL 69/69A Status page provides information necessary for activating SiriusXM Satellite Radio services. To access this page, navigate to the External LRUs list, or tap **Status**.

For information, refer to *GDL 69/69A SiriusXM Satellite Radio Activation Instructions*. For subscription activation instructions, visit <https://www.siriusxm.com/sxmaviation>.



If the Audio Radio ID and/or Data Radio ID do not display during GDL 69 operation, contact a Garmin dealer.

4.18 Browse Music Channels

SiriusXM Radio Options

- Channels 0 to 999
- Categories 0 to 63

Music provides both numeric entry and channel seek functionality.

4.18.1 Audio Category Selection

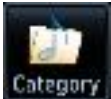

To filter the list of available channels according to a specific music type, tap **Category**.



Current Category Selection

Current Channel Selection

Category Key

Active Channel Indication

4.18.2 Direct Channel Tuning



To enter a specific radio channel by number, tap **Channel**.

ASSIGNING CHANNEL PRESETS

Quick Tuning Options

- Six preset groups
- Up to three preset channels per group

For quick tuning, use presets to store multiple channels in the unit's memory.



To assign a channel preset:

1. Select a channel.
2. Tap **Presets** until desired preset group displays.
3. Tap and hold any preset key for three seconds.

To select a preset:

1. Select a preset group.
2. Tap any preset key.

External Video



The Video page displays live video from up to four mounted cameras.

FEATURE REQUIREMENTS

- Composite or HD video camera input
- Purchased External Video feature enabled on GDU



**SD Display
(Control Window Active)**



HD Display

For GDU 1060 with dual MFDs, external video can only be viewed in one MFD at a time.

INPUT SOURCES

FORMAT	LIMIT
SD	2
HD	2

Two inputs are available for each video format. If an input source is not available, “No Video Input Signal” annunciates in place of a live image.



Camera designations are configured during installation.

PAN & ZOOM



Zooming magnifies the live image up to 10x its range. Zoom settings apply only to the active camera display. Panning allows movement of the zoomed image in any direction.

4.19 SD Video Setup

SD Display Settings

- Brightness
- Contrast
- Saturation

Selectable display settings are available for SD video only. HD display settings are configured at installation.

4.19.1 Settings Key



To open a control window, tap **Settings**.



To return to normal display mode, tap **Full**.

SETTINGS ADJUSTMENT

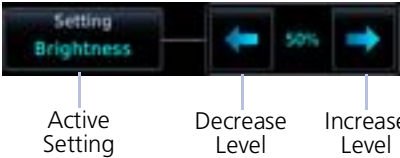

Directional keys allow adjustment of the active setting. Setting values are adjustable for each SD source.

RESTORE DEFAULTS

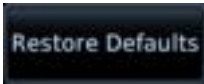

- Restores the active video display settings configured at installation
- Requires pilot confirmation

5 Weather Awareness

WEATHER DISPLAY

5.1	Weather Products	5-3
-----	------------------------	-----

DATALINK WEATHER

5.2	Weather Page Interactions	5-6
5.3	Weather Map Views	5-8
5.4	WX Display/Map Settings	5-9
5.5	Weather Product Age	5-10
5.6	Precipitation	5-11
5.7	Echo Tops	5-15
5.8	Clouds	5-15
5.9	Lightning	5-16
5.10	METARs and TAFs	5-17
5.11	Cell Movement	5-18
5.12	AIRMETs	5-19
5.13	Center Weather Advisory	5-22
5.14	SIGMETs	5-22
5.15	County Warnings	5-23
5.16	Cyclone/Hurricane Track	5-23
5.17	AIREP/PIREPs	5-24
5.18	Surface Analysis	5-25
5.19	City Forecast	5-25
5.20	Winds Aloft	5-26
5.21	Icing	5-27
5.22	Turbulence	5-29
5.23	Freezing Levels	5-30
5.24	TFRs	5-31
5.25	SiriusXM	5-32
5.26	FIS-B Weather	5-35
5.27	Connex Weather	5-39

STORMSCOPE

5.28	Stormscope Page	5-44
5.29	Stormscope Setup	5-45

AIRBORNE WEATHER RADAR

5.30	Weather Radar Page	5-47
5.31	Weather Radar Setup	5-49
5.32	Radar Modes	5-53
5.33	Radar Controls	5-56
5.34	Radar Alerts	5-60

Weather Display



Weather data displays as overlays on the dedicated weather page, Map page, and HSI Map. Available functions depend on the active weather source(s).



Common Weather Elements

5.1 Weather Products

WEATHER PRODUCT	WEATHER DISPLAY				
	MFD WX PAGE	MFD WX POP-UP TEXT	HSI MAP	MFD MAP PAGE	WAYPT INFO (ARPT)
AIRMET (Textual)	X, C	X, C			
AIRMET (Graphical)	F, X, C	F, X, C			
Cell Movement/SCIT	X	X		X	
Center Weather Advisory	F	F			
City Forecast	X	X			X
Cloud Top/IR Satellite	F, X, C			X, C	
County Warnings	X	X			
Cyclone Track	X				
Echo Tops	X			X	
Freezing Levels/Zero Degree Isotherm	X				
Icing Potential/SLD	F, X				
Lightning (Datalink)	F, X, C		F, X, C	F, X, C	
Lightning (Stormscope)	S		S	S	
METAR w/Decoding	F, X, C	F, X, C		F, X, C	F, X, C
NEXRAD/PRECIPI	F, X, C		F, X, C	F, X, C	
NOTAMS					F
AIREP	X	X			
PIREP	F, X, C	F, X, C			
SIGMET	F, X, C	F, X, C			
Surface Analysis	X				
TAF	F, X, C	F, X, C			F, X
Temps Aloft	F				
TFR	F, X, C	F, X, C	F, X, C	F, X, C	

WEATHER PRODUCT	WEATHER DISPLAY				
	MFD WX PAGE	MFD WX POP-UP TEXT	HSI MAP	MFD MAP PAGE	WAYPT INFO (ARPT)
Turbulence	F, X				
Weather Radar (on-board) [1]	W			W	
Winds Aloft	F, X, C				

[1] Not available on GDU 700() MFD/EIS.

LEGEND

Connex Product	C
FIS-B Product	F
On-board WX Radar Equipment	W
SiriusXM Product	X
Stormscope Product	S

Datalink Weather



WARNING

DO NOT RELY SOLELY ON DATALINK WEATHER FOR WEATHER INFORMATION. DATALINK WEATHER PROVIDES A SNAPSHOT IN TIME. IT MAY NOT ACCURATELY REFLECT THE CURRENT WEATHER SITUATION.



NOTE

Datalink weather is not intended to replace weather briefings or in-flight weather reports from AFSS or ATC.

FEATURE REQUIREMENTS

- FIS-B, GSR 56 transceiver, GDL 69/69A, or GDL 69/69A SXM receiver

Datalink weather services are available through FIS-B Weather, SiriusXM Weather, and Connex WX that transmit from a ground station or satellite.

5.2 Weather Page Interactions

ALTITUDE ADJUSTMENT KEYS



Plus and minus keys adjust altitude in increments for altitude-based weather products. Selectable altitude values vary by weather service and product. Includes:

- Icing
- Turbulence
- Winds Aloft

WEATHER ICONS

Tapping any weather icon displays an information banner. When applicable, a pop-up window displays additional data.



WX Info Banner Features

- Pan mode symbol
- Bearing and distance to map pointer from aircraft's current position
- Cloud Top altitudes
- Pan location
- Report data

AIRPORT ICONS



Tapping an airport icon displays information about local weather conditions.



PRODUCT LEGENDS

A scrollable legend provides relevant product colors and symbols via the data link weather menu page. Definitions are organized by product function.

To view a product legend, tap the **Menu** key and select **Legend**.



5.3 Weather Map Views

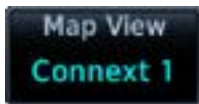

The **Map View** key in a weather menu may be used to select a user-configured view.



Three different views may be individually configured for each weather product. All settings configured in the weather product's menu are saved.

View configurations may be changed at any time.

Selecting any view loads previously saved view settings.

Tap **Customize** to change a view name or reset both the name and all menu settings to their default values.

5.4 WX Display/Map Settings

FEATURE LIMITATIONS

Shared map settings are per MFD instance, meaning that if you have a GDU 1060 with MFD 1 and MFD 2, each MFD has its own map settings. These settings are shared only with the datalink weather apps on that specific MFD. Map settings are not shared across multiple MFDs.

Several weather map display settings are based on selections made in the setup menu of the primary Map application.

From the Home page:

Tap **Map > Menu > Map Setup**, and select the appropriate tab. Applicable map settings are as follows:

Map Tab

Settings:

- North Up Above range
- LAT/LON Lines

Aviation Tab

Settings:

- Runway Extensions
- Airport Range
- Intersection Range
- NDB Range
- VOR Range
- VRP Range
- User Waypoint Range

Land Tab

Settings:

- Road Detail
- City Detail
- State/Province Borders
- River/Lake Detail

Changes to these map settings take effect immediately on the configured datalink weather app(s).

Map Settings and Multiple Map Views

Shared map settings are independent of map views. Map settings will transfer to a datalink weather app regardless of which map views you select.

5.5 Weather Product Age



NOTE

Data contained within a composite weather product may be older than its weather product age and should never be considered current.

A timestamp identifies the approximate time of data collection for each weather product. For quick reference, the age of each active weather product is calculated and shown in a color-coded side bar on the Weather and Map pages.

TIMESTAMP COLOR DEFINITIONS



Green

Weather product is considered current. Its age is newer than half its expiration time.

Tapping the Timestamp window displays time for all green colored weather products.

Yellow

Weather product is considered stale. Its age is older than half its expiration time.

A weather product may be yellow when its issue date and time occurs in the future by more than the complete expiration time for the requested weather product. (e.g., some TFRs).

Gray

Weather product data is one of the following:

- Expired
- Not received
- Not supported at the selected altitude

“No Data” or “ALT UNAVBL” displays next to the weather product title.



On PFD:

Timestamps for NEXRAD/PRECIP, lightning, and TFR products display in the HSI Setup menu.

5.6 Precipitation

AVAILABLE WITH:
FIS-B | SIRIUSXM | CONNEXT



WARNING

NEVER USE NEXRAD WEATHER FOR MANEUVERING IN, NEAR, OR AROUND AREAS OF HAZARDOUS WEATHER. NEXRAD IMAGES ARE SNAPSHOTS OF PAST WEATHER DATA. THEY ARE NOT SAFE FOR USE AS REAL TIME DEPICTIONS OF NEARBY WEATHER ACTIVITY.

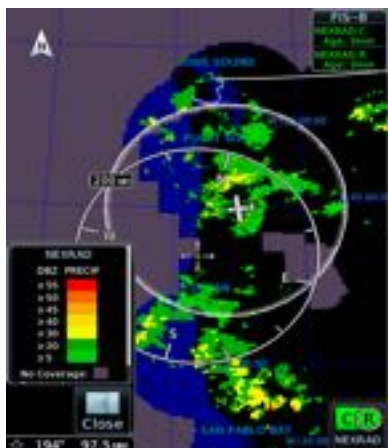
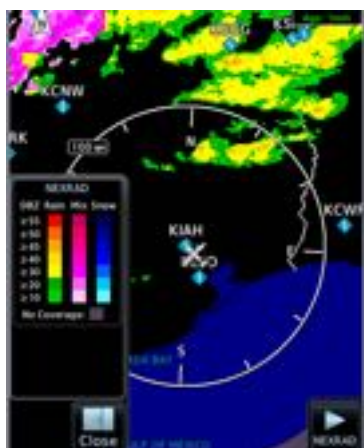

NEXRAD weather radar displays a mosaic of precipitation data, colored according to reflectivity. Composite reflectivity images depict the highest radar energy received from multiple antenna tilt angles at various altitudes. Base reflectivity images depict radar returns from the lowest antenna tilt angle.

The precipitation intensity level reflected by each pixel represents the highest level of composite radar reflectivity data sampled in that location.

A clear understanding of ground-based Doppler weather radar capabilities will allow you to interpret the NEXRAD weather imagery in the safest way possible. The National Oceanic and Atmospheric Administration hosts a description of the technology on its website: https://www.weather.gov/jetstream/doppler_intro

RADAR DATA ANIMATIONS



To depict trending weather movements over time, an animation function stitches the last three to six received radar images together in sequence, from oldest to newest, and replays them on a continuous loop. Play and stop controls are active when three or more NEXRAD images are available for playback.

5.6.1 Connex PRECIP

Precipitation products are available for areas around the world. For current coverage areas and product information, visit www.garmin.com/connex.

5.6.2 FIS-B NEXRAD

FIS-B NEXRAD is uplinked to the aircraft as two separate weather products: CONUS and Regional NEXRAD. Both products display individually or simultaneously, separated by a white hash-marked boundary. CONUS and Regional NEXRAD are selectable separately via the NEXRAD button on the bottom right of the weather map. FIS-B NEXRAD does not differentiate between liquid and frozen precipitation types.

REGIONAL

FIS-B Regional NEXRAD is a high-resolution weather image with a limited range, centered around each broadcasting ground station. The (high resolution) Regional NEXRAD pixels are 1.5 minutes (1.5 nautical miles = 2.78 km) wide by 1 minute (1 nautical miles = 1.852 km) tall. Each weather pixel varies with latitude. Above 60° latitude, pixel block widths double to 3 minutes/nautical mile for regional maps.

Depending on the locations of received FIS-B ground stations, Regional NEXRAD coverage can extend more than 250 nm around an aircraft's position. Aircraft flying at higher altitudes typically receive data from more ground stations than aircraft flying at low altitudes.

CONUS

FIS-B CONUS NEXRAD is a large, low-resolution weather image for the entire continental U.S. CONUS NEXRAD pixels are 7.5 minutes (7.5 nm = 13.89 km) wide by 5 minutes (5 nautical miles = 9.26 km) wide.

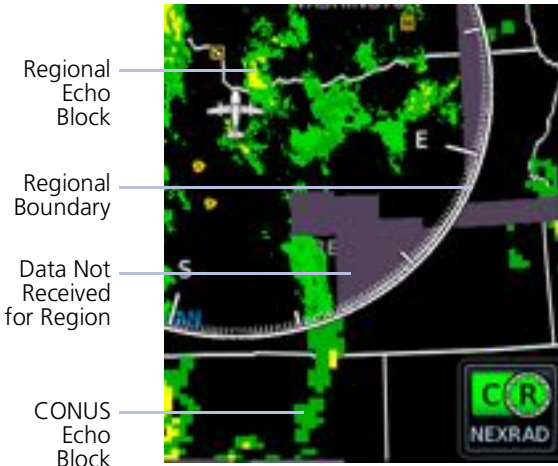

FIS-B Weather Display

Missing Data Indications

A semi-transparent mask indicates regions where data may be missing or incomplete. Color is dependent upon the presence of topographical data.

The mask is purple when there is no underlying topographical data, such as on the FIS-B weather display, or on Map when the TOPO overlay is off.

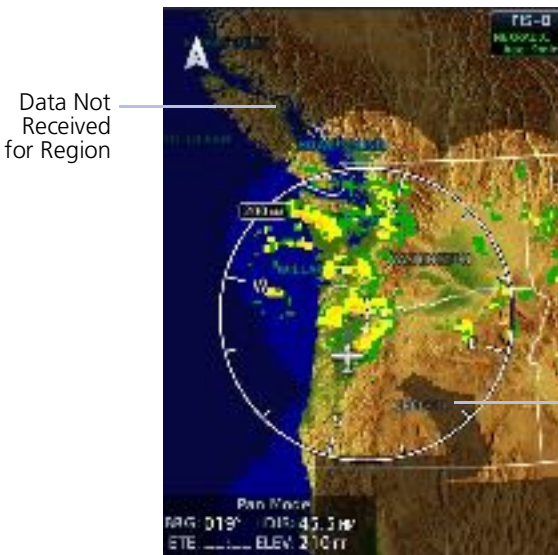

MFD Map Display

On Map, the mask is dark gray when the TOPO overlay is on, so that the underlying topographical features can still be interpreted.

5.6.3 SiriusXM NEXRAD

SiriusXM offers NEXRAD radar imagery from CONUS and non-CONUS sources. Weather menu options are Composite and Base.



Depending on the SXM service and installed GDL hardware, radar base reflectivity imaging may have broader coverage within North America or be limited to only Canada.

Source Options:

Composite (CONUS)

Composite reflectivity image of radar for the conterminous U.S.

Base

Base reflectivity image. Coverage and availability are dependent upon subscription.

Precipitation above 52° N may display as mixed precipitation regardless of actual precipitation type. Precipitation of an unknown type always displays as rain.

5.7 Echo Tops

AVAILABLE WITH: SIRIUSXM



Depicts the location, elevation, and direction of NEXRAD radar echoes. This information is useful for gauging storm intensity in a relative sense. A higher radar echo means a stronger storm updraft.

Due to similarities in color schemes, this product is mutually exclusive with Cloud Tops.

5.8 Clouds

5.8.1 Cloud Tops

AVAILABLE WITH:
FIS-B | SIRIUSXM



Indicates the altitude of the highest visible portions of a cloud at the time of measurement.

SXM cloud top altitude data is estimated from IR satellite imagery.

FIS-B cloud top data is generated by a computer model and has limited accuracy compared to actual conditions.

Due to similarities in color schemes, this product is mutually exclusive with Echo Tops.

5.8.2 IR Satellite

AVAILABLE WITH: CONNEXT



Infrared Satellite weather information is available for North America and Europe.

- Lighter grays depict colder temperatures
- Darker grays depict warmer temperatures

5.9 Lightning

AVAILABLE WITH:
FIS-B | SIRIUSXM | CONNEXT



SiriusXM Weather:

SXM displays a yellow cross icon to indicate a strike event occurring within a two kilometer region. Strike location is an estimate of its center.

Unlike Stormscope, the icon does not change shape or color as data ages.

Connex Weather:

Only cloud-to-ground strikes are reported through the Connex weather service.

FIS-B Weather:

Lightning strikes display as a bolt or cluster of bolts. The bolt color indicates the strike polarity.

5.10 METARs and TAFs

AVAILABLE WITH:
FIS-B | SIRIUSXM | CONNEXT

METAR and TAF reports provide information on current and forecast conditions. Colored METAR flags display for all TXi weather sources when a METAR reporting station is matched with a corresponding TXi navigation database identifier. When selected, the METAR is decoded and shows above the original METAR text. METARs are provided only in areas covered by the navigation database currently loaded.



METAR SYMBOLS

- VFR**
 Ceiling greater than 3,000 ft AGL and visibility greater than five miles.
- Marginal VFR**
 Ceiling 1,000 to 3,000 ft AGL and/or visibility three to five miles.
- IFR**
 Ceiling 500 to 1,000 ft AGL and/or visibility one to three miles.
- Low IFR**
 Ceiling below 500 ft AGL and/or visibility less than one mile.
- Unknown**
 Ceiling and/or visibility data unavailable.

5.11 Cell Movement

AVAILABLE WITH: SIRIUSXM

Information derived from NEXRAD displays the location of storm cells within a strong storm. Cell direction, speed, and storm top altitude is provided with a corresponding visual storm cell vector (arrow) indication.



5.12 AIRMETs

5.12.1 Textual AIRMETs

AVAILABLE WITH:
SIRIUSXM | CONNEXT

The AIRMET overlay draws the geographical boundaries of received AIRMETs on the dedicated weather page. AIRMETs include advisories of weather that may be particularly hazardous to single engine, light aircraft and VFR pilots. Tap an AIRMET graphic area to view the detailed AIRMET report text.



AIRMET TYPES

Icing	Areas of moderate airframe icing including areal extent
Turbulence	Areas of moderate turbulence including vertical extent
IFR	Weather conditions with ceilings <1,000 ft and/or visibility <3 mi
MTN OBSR	Widespread mountain obscuration due to clouds, precipitation, smoke, haze, mist, or fog
Surface Winds	Sustained surface winds >30 kt and/or potential non-convective wind shear below 2,000 ft AGL

5.12.2 Graphical AIRMETs

AVAILABLE WITH: FIS-B

Graphical AIRMETs (G-AIRMETs) display more weather phenomena than textual AIRMETs, while eliminating the need to interpret raw text.

Tapping a G-AIRMET displays textual details. Updates occur four times daily.



Filtering options allow you to mitigate page clutter. Forecast and filter selections are accessible from the FIS-B Weather menu.

Forecast Settings:

Off

Disables automatic functionality.
Filter options not available.

Current (Auto)







Displays active graphical records based on the current UTC.
Function automatically switches from 0 hr to 3 hr forecasts.

All Forecasts

Displays the most recent, non-expired graphical records.

Forecast periods include 0 hr, 3 hr, and 6 hr.

G-AIRMET FILTERS

	Freezing Level		MTN OBSCR
	Icing		Surface Winds
	IFR		Turbulence
	Low-level Wind Shear		

To view graphical AIRMETS:

1. Home > **Weather** > **FIS-B Weather** > **Menu**.
2. Toggle **G-AIRMET** on.
3. Tap **Settings**.
4. Select between **Current (Auto)** and **All Forecasts**.
5. Select one or more filters.
6. Return to the FIS-B Weather page.
7. Select any G-AIRMET line to view details.

5.13 Center Weather Advisory

AVAILABLE WITH: FIS-B

These advisories communicate en route and terminal weather conditions expected to occur within the next two hours. Information is valid for up to 2 hours.



5.14 SIGMETs

AVAILABLE WITH:
FIS-B | SIRIUSXM | CONNEXT

The SIGMET overlay draws the geographical boundaries of received SIGMETs on the dedicated weather page. Convective and non-convective SIGNificant METeological Information combine in a textual report and display graphically for the observed or forecast region. The SIGMET text displays when the graphical SIGMET is selected. Touch the graphical depiction for additional information.



5.18 Surface Analysis

AVAILABLE WITH: SIRIUSXM



Displays weather fronts, high (H) and low (L) pressure centers, and isobars.

Forecast Period Options:

- Current • 12 hour • 24 hour
- 36 hour • 48 hour

5.19 City Forecast

AVAILABLE WITH: SIRIUSXM

Four-day forecasts for major U.S. cities, including daily forecast high and low temperatures, chance of precipitation, and sky conditions.



5.20 Winds Aloft

AVAILABLE WITH:
FIS-B | SIRIUSXM | CONNEXT



Indicates wind speed and direction, and temperature forecast for the specified altitude.

The wind barb extends outward from the reporting location dot in the direction of wind origination.

Reporting altitudes vary depending on the weather provider.

FIS-B Winds & Temperatures Aloft: FIS-B wind forecasts also provide temperature data for the selected altitude. These forecasts update every 12 hours.

Altitude Range:

FIS-B	SIRIUSXM & CONNEXT
1,000 ft	
1,500 ft	
2,000 ft	
3,000 ft	
6,000 ft	
9,000 ft	
12,000 ft	
15,000 ft	
18,000 ft	
24,000 ft	
30,000 ft	
34,000 ft	
39,000 ft	
45,000 ft	Surface to 45,000 ft (at 3,000 ft intervals)
53,000 ft	SiriusXM data not available at 45,000 ft

Not all altitudes provide winds and temperatures aloft forecasts for all regions.

5.21 Icing

AVAILABLE WITH:
FIS-B | SIRIUSXM



NOTE

Due to the incremental and overlapping nature of the FIS broadcast, timestamps, regional coverage, and map data availability may vary with altitude for computer generated FIS-B icing forecasts.

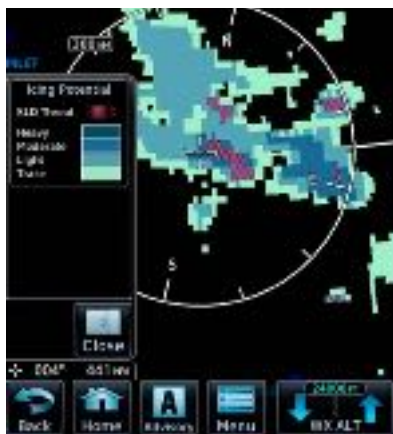



The Icing potential shows a graphic view of the current icing conditions. SLD threat areas are depicted as black and pink blocks over the icing colors.

Directional keys allow you to adjust the reporting altitude within product-specific limits.

	FIS-B	SIRIUSXM
Timestamp shows:	Valid time in UTC	Time of data compilation
Altitude Range:	2,000 to 24,000 ft (at 2,000 ft intervals)	1,000 ft 3,000 ft 6,000 ft 9,000 to 30,000 ft (at 3,000 ft intervals)

ICING CATEGORIES

	SLD Threat
	Heavy
	Moderate
	Light
	Trace ^[1]
	No Coverage ^[2]

Categories vary depending on the configured weather source.

Icing potential is not a forecast, but a presentation of icing potential at the time of analysis. Supercooled Large Droplet (SLD) icing conditions are characterized by the presence of relatively large, super cooled water droplets indicative of freezing drizzle and freezing rain aloft.

^[1] Available only from certain weather sources. ^[2] FIS-B Weather only.

5.22 Turbulence

AVAILABLE WITH:
FIS-B | SIRIUSXM



NOTE

Due to the incremental and overlapping nature of the FIS broadcast, timestamps, regional coverage, and map data availability may vary with altitude for FIS-B turbulence forecasts.



Turbulence data identifies the potential for erratic movement of high-altitude air mass associated winds. This information is intended to supplement AIRMETs and SIGMETs.

Turbulence is classified as light, moderate, severe or extreme.

Directional keys allow you to adjust the reporting altitude within product-specific limits.

	FIS-B	SIRIUSXM
Timestamp shows:	Valid time in UTC	Time of data compilation
Altitude Range:	2,000 to 24,000 ft (at 2,000 ft intervals)	21,000 to 45,000 ft (at 3,000 ft intervals)

Data may not be available for all regions at all altitudes.

5.23 Freezing Levels

AVAILABLE WITH:
FIS-B | SIRIUSXM



Color-coded contour lines indicate the altitude of the freezing level.

FIS-B freezing levels display as a G-AIRMET. Updates occur four times daily.

5.24 TFRs

AVAILABLE WITH:
FIS-B | SIRIUSXM | CONNEXT



WARNING

DO NOT EXCLUSIVELY USE DATALINK SERVICES FOR TFR INFORMATION. TFR DEPICTIONS ON THE GDU MAY NOT BE A COMPLETE LISTING AND MAY VARY BETWEEN COCKPIT DEVICES. ALWAYS CONFIRM TFR INFORMATION WITH OFFICIAL SOURCES SUCH AS FLIGHT SERVICE STATIONS OR AIR TRAFFIC CONTROL.

TFRs identify areas of airspace where aircraft are temporarily restricted from operating. They are routinely issued for occurrences such as dignitary visits, military activities, and forest fires.

Tapping a TFR displays textual details.



FIS-B Weather:

Latest TFR data transmit every 10 to 20 minutes.

For FIS-B datalink weather, TFRs and NOTAMs that do not include geographical locations are viewable from the FIS-B Raw Text Reports page.

5.25 SiriusXM



SiriusXM satellites deliver high bandwidth (S-band) data to provide high-resolution images. Available data is received within a few minutes after the aircraft satellite receiver comes into view of the SiriusXM satellite network.

FEATURE REQUIREMENTS

- Active SiriusXM Aviation Weather subscription
- Data Radio ID
- Configured GDL 69/69A interface

FEATURE LIMITATIONS

- For Icing Potential, Winds Aloft (U.S.), and Turbulence, the valid time displays instead of product age
- For Freezing Level and Winds Aloft (Canada), the generation time displays instead of valid time

5.25.1 SiriusXM Weather Setup

SiriusXM Weather Menu

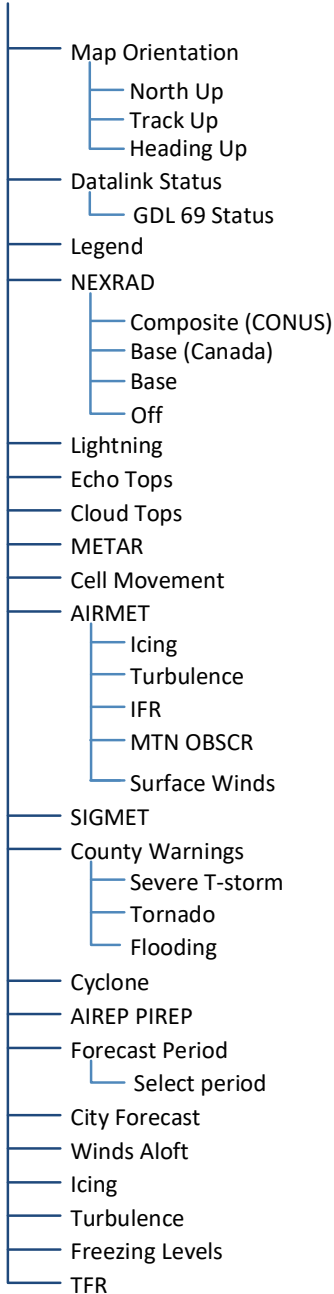

5.25.2 Activating Services

Before SiriusXM Weather is accessed, service must be activated by the SiriusXM customer service. This is accomplished by providing either one or two coded IDs, SiriusXM Satellite Weather (data) and SiriusXM Satellite Radio (audio). The coded IDs are used to send an activation signal, which allows the use of weather and entertainment products received by the GDL 69/69A.

For subscription activation instructions, visit siriusxm.com.

To complete activation:

1. Contact SiriusXM using the customer service phone number listed on the website.
2. Provide the customer service agent with your Data ID and Audio ID.
3. Position aircraft within satellite reception area and power unit.
4. Tap **Weather > SiriusXM Weather > Menu > Datalink Status**.
5. Verify activation. Status page displays Data ID, Subscription Level, and weather product listings.
6. Tap **Menu > Lock activation > OK**.

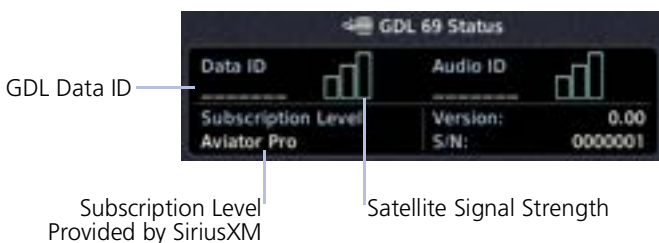

GDL 69 Status Page

5.25.3 SiriusXM Weather Products



When SiriusXM weather services are not activated:

- All weather product boxes are cleared on the GDL 69 Status page
- A yellow “Activation Required” message appears at the center of the page

Service Class refers to the groupings of weather products available for subscription.

5.26 FIS-B Weather



No pilot action is required to receive FIS-B weather information.

FIS-B weather products include:

- NEXRAD
- Icing
- METAR
- Center WX Advisory
- Cloud Tops
- Turbulence
- PIREP
- G-AIRMET
- Lightning
- Winds/Temps Aloft
- SIGMET
- TFR

FEATURE REQUIREMENTS

- UAT receiver (GDL 88, GNX 375, GTX 345)

The FAA provides FIS-B as a Surveillance and Broadcast Service operating on the UAT (978 MHz) frequency band. FIS-B uses a network of FAA-operated ground-based transceivers to transmit weather datalink information to the aircraft's receiver on a scheduled continuous basis.

The Flight Information Service-Broadcast (FIS-B) Weather service is freely available for aircraft equipped with a capable datalink universal access transceiver (UAT). Ground stations provide uninterrupted services for the majority of the contiguous U.S., Hawaii, Guam, Puerto Rico, and parts of Alaska. No weather subscription service is required. For the latest FAA ground station coverage information, visit: www.faa.gov/nextgen/programs/adsb/

FIS-B weather product update and transmission intervals are published in the SBS Description Document associated with TSO-C157b. This information is available electronically at the FAA's Regulatory and Guidance Library: <https://rgl.faa.gov/>

5.26.1 FIS-B Data Transmission Limitations

FIS-B broadcasts provide weather data in a repeating cycle which may take several minutes to completely transmit all available weather data. Therefore, not all weather data may be immediately present upon initial FIS-B signal acquisition.

LINE OF SIGHT RECEPTION

To receive FIS-B weather information, the aircraft's datalink receiver must be within range and line-of-sight of an operating ground-based transceiver. Reception may be affected by altitude, terrain, and other factors. Per the FAA, much of the United States has FIS-B In airborne coverage at and above 3,000 feet AGL. Terminal coverage is available at altitudes below 3,000 feet AGL and is available when flying near approximately 235 major U.S. airports. Surface coverage allows FIS-B ground reception at approximately 36 major U.S. airports.

PER FAA TSO-C157B

FIS-B information may be used for pilot planning decisions focused on updating the pilot's awareness of the dynamic flight environment; including avoiding areas of inclement weather that are beyond visual range and pilot near-term decisions where poor visibility precludes visual acquisition of inclement weather. FIS-B weather and NAS status information may be used as follows:

- a. To promote pilot awareness of ownship location with respect to reported weather, including hazardous meteorological conditions; NAS status indicators to enhance pilot planning decisions; and pilot near-term decision-making.
- b. To cue the pilot to communicate with Air Traffic Control, Flight Service Station specialist, operator dispatch, or airline operations control center for general and mission critical meteorological information, NAS status conditions, or both. FIS-B information, including weather information, NOTAMs, and TFR areas, are intended for the sole purpose of assisting in long-/near-term planning and decision making. The system lacks sufficient resolution and updating capability necessary for aerial maneuvering associated with immediate decisions. In extreme scenarios, the oldest weather radar data on the display can be up to 15 to 20 minutes older than the display's age indication for that weather radar data. Therefore, do not attempt to use FIS-B weather information to maneuver the aircraft at minimum safe distances from hazardous weather. FIS-B information must not be used in lieu of a standard preflight briefing.
- c. [Displaying FIS-B weather using GDL 88, GNX 375, or GTX 345 Class 1 transceivers] FIS-B uplink is a subscription-free FIS broadcast managed by FAA SBS. It provides an FAA approved source for METAR, TAF, WINDS, PIREPs, NEXRAD, AIRMET, SIGMET, and TFR information, and is subject to the broadcast range limits for these products. FIS-B uplink is not an FAA approved source for NOTAMs.

NOTAM 30-DAY LIMITATION

NOTAMs received via FIS-B may not be a complete listing. Active NOTAMs are removed from the FIS-B data stream 30 days after issuance. Before flight, review all necessary aeronautical and meteorological information from official sources. For more information, consult AC 00-63.

5.26.2 FIS-B Weather Setup

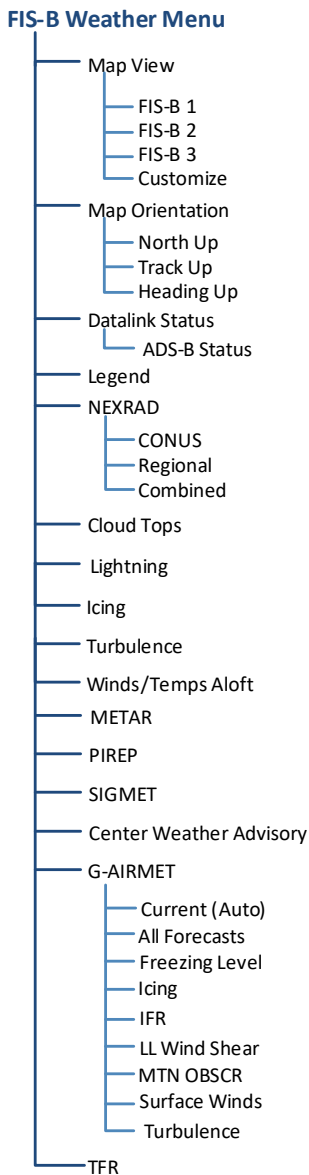

5.26.3 Raw Text Reports

Access FIS-B raw text data by tapping the **Raw Text Reports** key on the ADS-B Status page. Selecting a FIS-B data link textual product accesses the latest uploaded data.



To display Raw Text Reports from the FIS-B Weather Menu, tap:

Datalink Status > Raw Text Reports

Tap **Raw Text Reports** for FIS-B Textual Data

5.26.4 FIS-B Ground Reception Status

FIS-B ground station transmission status may be monitored when the UAT transceiver is powered and the FIS-B weather option is selected. A current report lists completeness of NOTAM-TFR, G-AIRMET, CWA, and SIGMET data for all received ground stations.

For the received ground station, the station range field indicates complete/incomplete status only for those products within the ground station's range.



To access the FIS-B Reception Status page from the FIS-B Weather menu, tap **Datalink Status > Radio Stations**.

5.27 Connex Weather

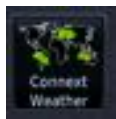

Garmin provides Connex datalink, on-demand weather products through the Iridium satellite system via a GSR 56 transceiver and L-band frequencies. An Iridium satellite data subscription service is required for worldwide Connex weather coverage.

FEATURE REQUIREMENTS

- GSR 56 transceiver
- Data plan

Connex Weather coverage is available throughout most of Europe, Canada, and the U.S. Additional radar coverage areas are added continuously. For the latest radar coverage information, visit:

<https://fly.garmin.com/fly-garmin/connex/worldwide-weather/>

Various world-wide weather subscription package options provide weather reporting for most of Europe, Canada, Australia, and the U.S.

5.27.1 Activating Connex Services

To access Connex Weather, visit flyGarmin.com and create a Connex Satellite Services account. Be ready to provide the GDU ID, airframe information (model, tail number), and Iridium serial number. Garmin will issue an access code for entry on the Connex Registration page. If access code and system ID are correct, the airframe registration details will display.

To complete activation:

1. Move aircraft within satellite range and power unit.
2. Go to MFD home page.
3. Tap **Weather > Connex Weather > Menu > Connex Settings > Datalink Status > Connex Registration > Access Code**.
4. Enter the required code, then tap **Register** to complete the process.

5.27.2 Deactivating Connex Unit Registration

Specific GDU Connex registration can be deactivated in order for the unit to no longer make requests to Connex. This does not cancel the subscription. While viewing the Connex Registration display page, tap **Access Code**.

Enter an invalid access code to deactivate the Connex registration. Weather requests will now fail and the system will no longer link to the Connex account.



Connex Registration Page

5.27.3 Connex Weather Product Age



Connex weather product requests are pilot controlled. Weather products are refreshed at intervals that are defined and controlled by Connex and its data vendors.

Weather product age is based on the time difference between when the data was assembled by Connex and current GPS time. Weather products expire at intervals based on each product. When the data expires, it is removed from the display. This ensures that displayed data is consistent with what is currently provided by Connex Satellite Radio services.

5.27.4 Connex Weather Setup

Connex Weather Menu

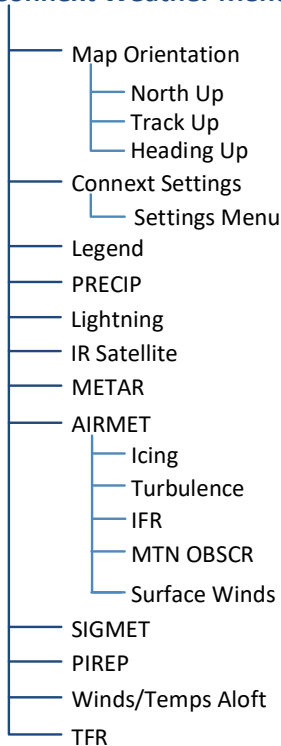

Connex Settings Menu

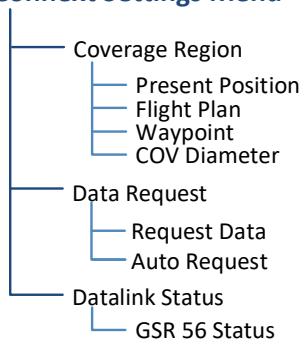

5.27.5 Connex Data Requests



Connex weather data may be updated on an on-request basis. This feature allows the pilot to download selected weather products for a specific waypoint, flight plan, or destination, and the time frame.

Access is via the Connex Settings menu.

Coverage Boundary



The pilot can update Connex weather data at any time regardless of predetermined automatic update frequency.

CONNEXT WEATHER REQUEST CONTROLS

Present Position	Request weather information around aircraft's present position. COV diameter determines extent of request.
Destination	Request weather information for the destination airport.
Flight Plan	Request weather information for the active flight plan route.
Distance	Enter requested weather information for a specified distance along the active flight plan. Range: 10 nm to 500 nm
Waypoint	Request weather information for a specified waypoint.
COV Diameter	Define the diameter of coverage. Range: 10 nm to 500 nm
Request Data	Request weather data at any time. Reset Auto Request timer (if active) for next request interval.
Auto Request	Select the automatic weather request period. Options: Off, 5 min, 10 min
Datalink Status	View Iridium satellite datalink status and signal strength.

Stormscope



Stormscope lightning data display on a dedicated weather page or as overlays on Map page and HSI Map.

5.28 Stormscope Page



WARNING

DO NOT EXCLUSIVELY USE THE LIGHTNING DETECTION SYSTEM FOR WEATHER AVOIDANCE. THE SYSTEM MAY DISPLAY INACCURATE OR INCOMPLETE INFORMATION. REFER TO THE LIGHTNING DETECTION SYSTEM DOCUMENTATION FOR ADDITIONAL INFORMATION.

FEATURE REQUIREMENTS

- WX-500 Stormscope Weather Mapping Sensor

FEATURE LIMITATIONS

- Stormscope lightning information cannot display concurrently with a data link (SiriusXM, Connex, or FIS-B) Lightning weather product

Stormscope Features

- Passive weather avoidance system
- Detects electrical discharges from thunderstorms within 200 nm of current position
- Plots strike count and relative bearing location every two seconds
- Heading and distance from aircraft
- Arc and 360° viewing options

For additional information, consult the WX-500 pilot's guide.

5.29 Stormscope Setup

Stormscope Menu

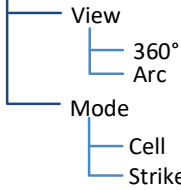

Setup options reside in the setup menu.

Changes in mode selection on the Stormscope page reflect across all lightning overlays (Map page, HSI Map).





5.29.1 Stormscope Modes & Symbols

CELL

Cell mode identifies cluster of electrical activity, grouping individual strikes together. Use Cell mode during heavy storm activity to identify where storm cells are located.

STRIKE

Strike mode plots discharge points in relation to where the individual discharges are detected. Strike mode displays the initial strikes associated with a building thunderstorm in relation to where it's detected.

SYMBOL	TIME SINCE STRIKE (SECONDS)
	Less than 6 (lightning bolt indicates initial strike)
	Less than 60
	Less than 120
	Less than 180

STRIKE RATE

Strike Rate reports the approximate number of strikes per minute for a given view range. It is useful when trying to determine if storm cells are building or decaying.

Mode: Strike Rate: 47

Strikes occur at a higher rate as a storm matures. They are less frequent as the storm dissipates.

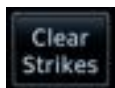

To reset the rate value, clear the page of all strikes.

5.29.2 Views

Stormscope provides both arc and 360° views of lightning data.

ARC VIEW



Strike Mode



Cell Mode

360° VIEW

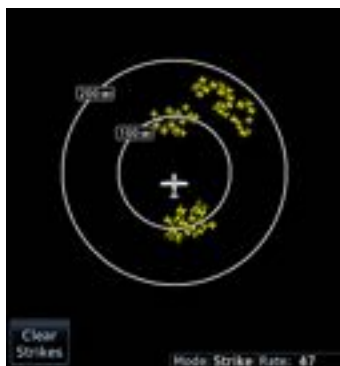

Strike Mode



Cell Mode

Airborne Weather Radar



Weather radar data display on a dedicated weather page or as overlays on the Map page.

5.30 Weather Radar Page



WARNING

USE WEATHER RADAR TO AVOID SEVERE WEATHER, NOT TO ENTER IT.

FEATURE REQUIREMENTS

- GDU 1060 or full screen MFD on GDU 700P

FEATURE LIMITATIONS

- Available modes and intensity levels depend on the installed radar type
- Not available on GDU 700() EIS/MFD

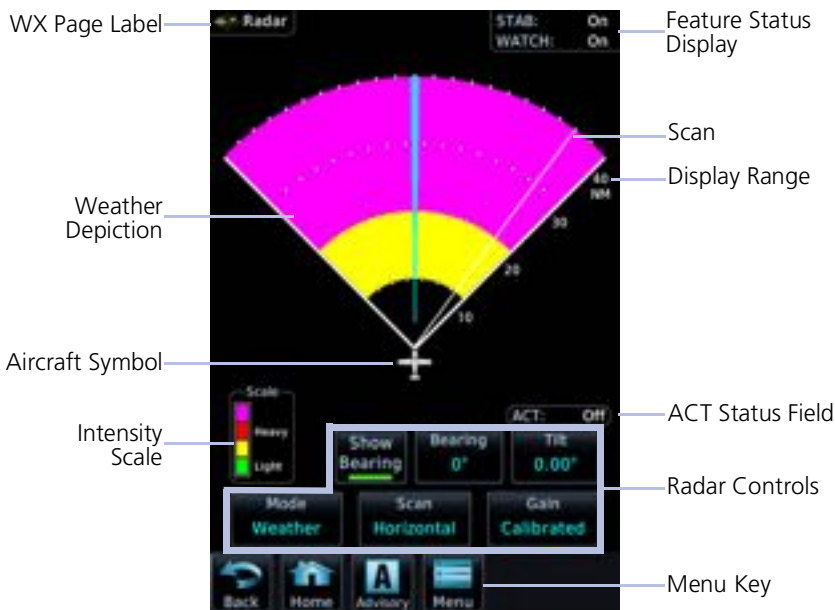

Weather Radar Page

RADAR UNITS

Distances on the Weather Radar page display in nautical miles.

DISPLAY ADJUSTMENTS

To change radar display range, adjust the inner control knob.

To adjust tilt and bearing angle, tap and drag the line indicator as necessary, or use the associated control keys.

INTENSITY SCALE



Weather



Ground

Each operating mode uses a unique color palette to depict increasing intensity levels.

WARM-UP COUNTDOWN TIMER



A warm-up period initiates upon power up (GWX 68 only). Duration varies depending on how long the radar is off. The radar begins transmitting once warm-up is complete.

5.31 Weather Radar Setup

Radar Menu

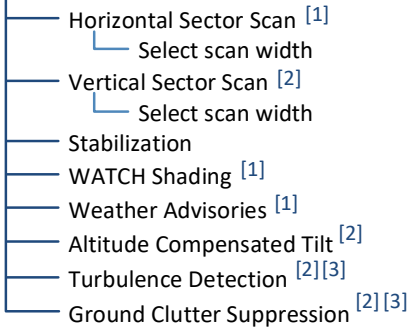

Available setup options are dependent upon configuration.

With the exception of Sector Scan, all selections are on/off only.

[1] Not available for third-party radars.

[2] GWX 70/75 only.

[3] Requires feature enablement.

5.31.1 Sector Scan

The sector scan option focuses the scan on a smaller segment of the radar sweep. This is useful when monitoring priority weather targets.

SCAN	INCREMENTS
Horizontal	20°, 40°, 60°, 90°, Full
Vertical	10°, 20°, 30°, Full
The 90° horizontal scan option is available only for radars with extended scan capabilities (120° sweep).	

Increments vary according to scan type.

Horizontal sector scans center on the bearing line, vertical sector scans center on the tilt line.

5.31.2 Stabilization

This feature helps stabilize the antenna so the scan is parallel to the ground when active. When off, the antenna scan is relative to the aircraft lateral axis. Status displays in the upper right corner of the Radar page.

5.31.3 WATCH

FEATURE LIMITATIONS

- Not available for third party radars

Use WATCH to determine areas of inaccuracies in displayed intensity from attenuation while in horizontal scan mode. Adjust tilt to determine the extent of attenuation in a shaded area. WATCH only displays in horizontal scans.

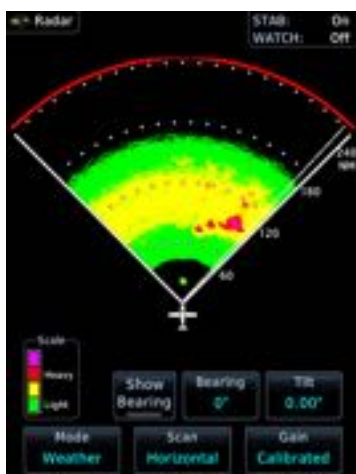

WATCH Off

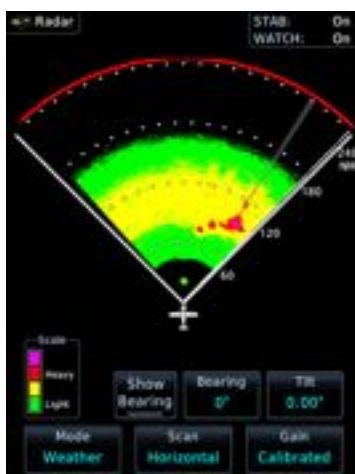

WATCH On

5.31.4 Weather Alert

FEATURE LIMITATIONS

- Not available for third party radars

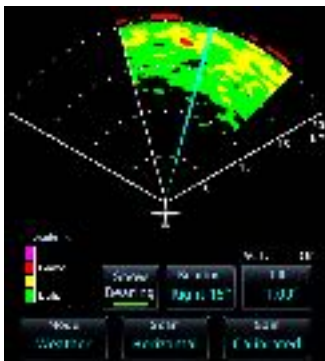

These alerts indicate the presence of heavy precipitation beyond the current display range (80 nm to 320 nm from current position).

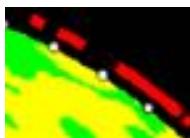

Red bands on the outer range ring display at the approximate azimuth of severe weather targets.

If the antenna tilt is adjusted too low, a weather alert is generated by ground returns. If a weather alert is detected within ± 10 degrees of the aircraft heading, an advisory displays on the MFD in the advisory window.

5.31.5 Altitude Compensated Tilt

FEATURE LIMITATIONS

- GWX 70/75 only



This feature adjusts the tilt to compensate for altitude changes as the aircraft climbs and descends. Status displays above the radar controls.

5.31.6 Turbulence Detection

FUNCTIONAL REQUIREMENTS

- Purchased GWX Turbulence Detection feature enabled on GDU

FEATURE LIMITATIONS

- GWX 70/75 only

This feature detects and displays severe turbulence. Status reports as inactive when:

- Current scan range is greater than 160 nm
- Radar is not in weather mode
- Vertical scan is active



Turbulence Off



Turbulence On

5.31.7 Ground Clutter Suppression

FEATURE REQUIREMENTS

- Purchased GWX Ground Clutter Suppression feature enabled on GDU

FEATURE LIMITATIONS

- GWX 70/75 only
- Not available for vertical scans

This feature reduces the amount of returns of highly reflective objects on the ground, while maintaining the intensity and size of weather returns.

5.32 Radar Modes



WARNING

DO NOT TRANSMIT WHEN PERSONNEL OR OBJECTS ARE WITHIN 11 FEET OF THE ANTENNA.



CAUTION

PLACE RADAR IN STANDBY MODE BEFORE TAXIING TO PREVENT DAMAGE TO THE RADAR ASSEMBLY.

5.32.1 Mode Key



Tapping this key opens a list of available mode options.



A confirmation pop-up alerts the pilot when attempting to scan while on the ground.

STANDBY



- Parks the antenna at the centerline
- **Scan** and **Gain** controls are inactive
- Automatic standby occurs during power up and landing

Inactive

TEST



- Places transmitter in standby as the display simulates a radar sweep
- Test data verifies communication between the weather radar and display
- Radar pulses do not transmit from the antenna during this mode

GROUND

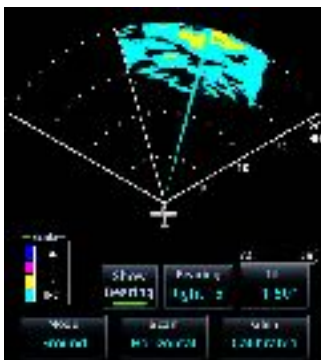

- Presents a depiction of terrain similar to that of a topographical map
- Useful when trying to verify aircraft position

GROUND MAP MODE COLOR	GROUND TARGET INTENSITY LEVELS	
	GWX RADAR INTENSITY	THIRD-PARTY RADAR LEVEL
Black	0 dB	0
Light Blue	> 0 dBZ to < 9 dBZ	1
Yellow	9 dBZ to < 18 dBZ	2
Magenta	18 dBZ to < 27 dBZ	3 and above
Blue	27 dBZ and greater	Not used

WEATHER

- Presents an airborne depiction of precipitation
- Colors represent approximate rainfall intensity and rates for weather radar targets

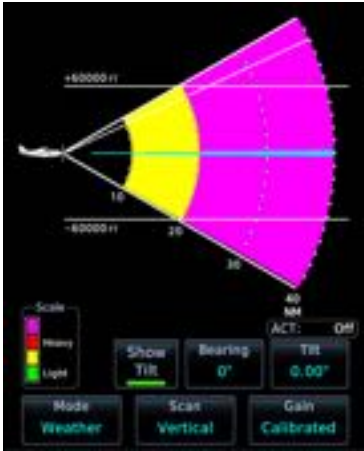

GWX 68/70

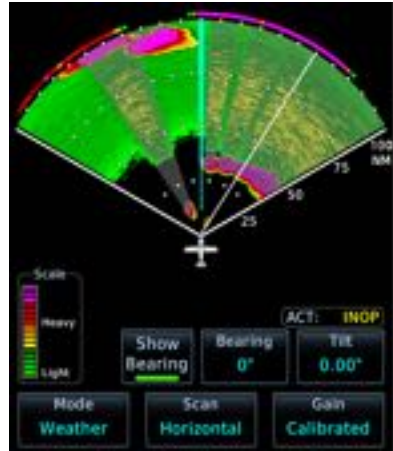

GWX 75

WEATHER MODE COLOR	GWX 68/70/75 RADAR		THIRD-PARTY RADAR
	APPROXIMATE INTENSITY	APPROXIMATE RAINFALL RATE (IN/HR)	RADAR RETURN LEVEL [1]
Black	< 23 dBZ	< .01	0
Green	23 dBZ to < 33 dBZ	.01 to < 0.1	1
Yellow	33 dBZ to < 41 dBZ	0.1 to < 0.5	2
Red	41 dBZ to < 49 dBZ	0.5 to < 2.0	3
Magenta	49 dBZ and greater	2.0 and greater	4
White	Turbulence Detection [2]		

[1] Consult the appropriate third-party radar documentation.

[2] GWX 70 and GWX 75 radar only.

5.33 Radar Controls

Weather Radar Page

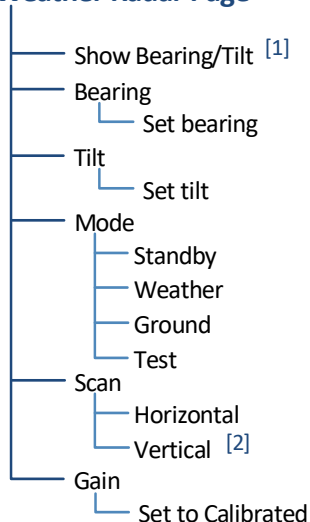

Some radars allow independent sweeps when connected to multiple displays.

[1] Dependent on scan type selection.

[2] Not available for RS 181 and RS 811 radars.

5.33.1 Show Bearing/Tilt

Displays the tilt or bearing line depending on current scan selection. This feature is useful when making horizontal or vertical scan adjustments.

5.33.2 Bearing

FEATURE LIMITATIONS

- Not available on RS 181 and RS 811 radars



Directional keys allow fine adjustment of the bearing line angle. This method is optional to tapping and dragging.

5.33.3 Tilt

Use antenna tilt to locate the top and bottom of storm cells and to increase intensity of ground target returns. One degree of tilt equals 100 feet of altitude per nautical mile. In areas of multiple heavy cells, use the vertical scan feature along with antenna tilt to examine the cells. Avoid shadowed areas behind targets.

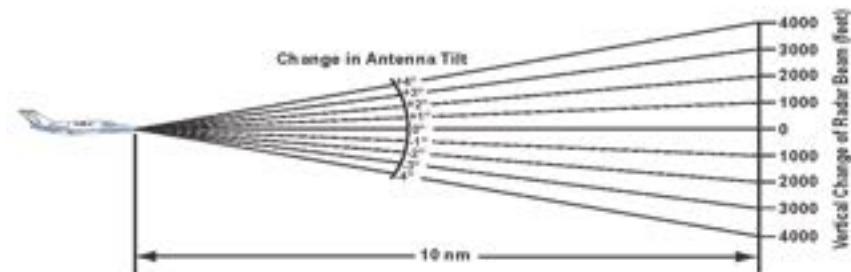

A typical tilt setup adjusts the bottom of the radar beam to 4° below parallel with the ground. To adjust the antenna tilt for this typical setup:

1. Fly the aircraft level.
2. Adjust antenna tilt so ground returns display at a distance equal to the aircraft's current altitude (AGL) divided by 1,000.

When flying at altitudes between 2,000 and 30,000 ft AGL with the typical tilt setup, avoid target returns at 5 nm. These may be either weather or ground returns that are 2,000 ft or less below the aircraft. Raise the antenna tilt 4° to separate ground returns from weather returns in flat terrain. Return the antenna to the previous setting after a few sweeps of the radar. Set the display range to 60 nm for aircraft flying at 15,000 ft or lower. Monitor ground returns for possible threats.

If flying above 29,000 ft with the typical tilt setup, be cautious of targets 30 nm or closer. This may indicate a thunderstorm that the aircraft cannot fly over safely.

5.33.4 Scan

FEATURE LIMITATIONS

- RS 181 and RS 811 radars do not support vertical scan functionality

Horizontal scans provide a visual depiction of weather in front of the aircraft. Vertical scans focus the radar on a particular vertical target.

HORIZONTAL

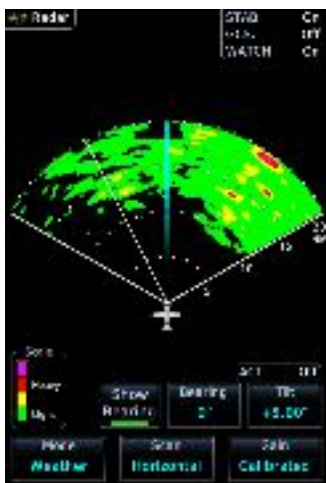

For bearing line visibility, tap **Show Bearing**.

To adjust the horizontal scan bearing:

- Tap and drag the bearing line left or right

Or

- Adjust the angle using the **Bearing** control

To adjust vertical angle for the horizontal scan, tap **Tilt** and then adjust the angle using directional keys.

VERTICAL

When vertically scanning with stabilization on, the physical area that the radar is sweeping may not match the displayed vertical scan. This occurs when the aircraft pitch is not at 0°. To compensate, the GDU does not draw the unscanned portion.

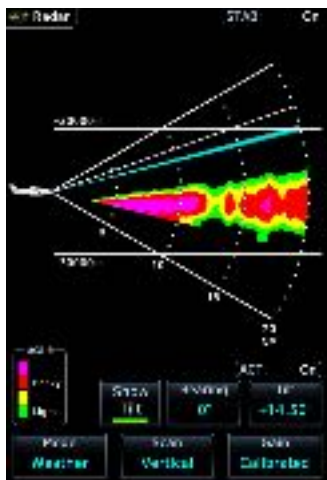

For tilt line visibility, tap **Show Tilt**.

To adjust the tilt of vertical scan:

- Tap and drag the tilt line up or down

Or

- Adjust the angle using the **Tilt** control

To adjust horizontal angle for the vertical scan, tap **Bearing** and then adjust the angle using directional keys.

5.33.5 Gain



NOTE

Precipitation intensity may not be accurate if the gain is changed.

FEATURE LIMITATIONS

- For third party radars, this control is active only during ground mode

This feature controls the sensitivity of the radar receiver. Adjustments to receiver sensitivity automatically change the intensity of radar targets.



Directional keys allow sensitivity adjustments.

Tapping **Set to Calibrated** restores the calibrated gain setting and returns intensity depictions to their actual colors.

5.34 Radar Alerts

A caution message alerts the pilot of a weather radar failure. Scan depictions on Weather Radar and Map pages do not display.

Weather radar overlay detail is absent from the Map page if heading input is lost.

ANNUNCIATION	ALERT TYPE & CONDITION
RADAR FAULT	Alert Type: Caution
	Condition:
	Data contains a fault unrelated to attitude.
RADAR FAIL	Alert Type: Caution (GWX only)
	Condition:
	Weather radar product status is timed out.
RADAR CONTROLS DISAGREE	Alert Type: Caution (Third-party radars only)
	Condition:
	Radar's actual state does not match the commanded state.
RADAR ACTIVE	Alert Type: Caution (GWX 70/75 and third-party radars)
	Condition:
	Radar is in standby, but remains active due to another interfacing controller.

6 Traffic Awareness

TRAFFIC DISPLAY

6.1	Traffic Page	6-3
6.2	Traffic Setup	6-6

TRAFFIC TYPES

6.3	TIS-A	6-8
6.4	TAS/TCAS I	6-10
6.5	TCAS II	6-12
6.6	ADS-B	6-16
6.7	Traffic Alerts	6-21

Traffic Display



The Traffic page displays intruding traffic in relation to the current position and altitude of the aircraft without clutter from other data.

Collision avoidance and traffic surveillance data display on the Traffic page or as overlays on the Map page and HSI Map. Synthetic vision traffic depictions display on PFD when SVT is enabled.

Available Traffic Sources

- TIS-A
- TAS/TCAS I
- ADS-B with or without TCAS
- TCAS II

The availability of functions, alerting features, and options depend on the traffic system source.

ADS-B controls are accessible from the Traffic menu. Controls for other traffic systems are located on the Traffic page.

FEATURE LIMITATIONS

- Symbols depicted depend on traffic source (e.g., TIS-A, TAS, ADS-B)
- Intruding aircraft without altitude reporting capabilities do not display altitude separation data or climb/descent indications
- Available display ranges and vector types depend on traffic source

6.1 Traffic Page

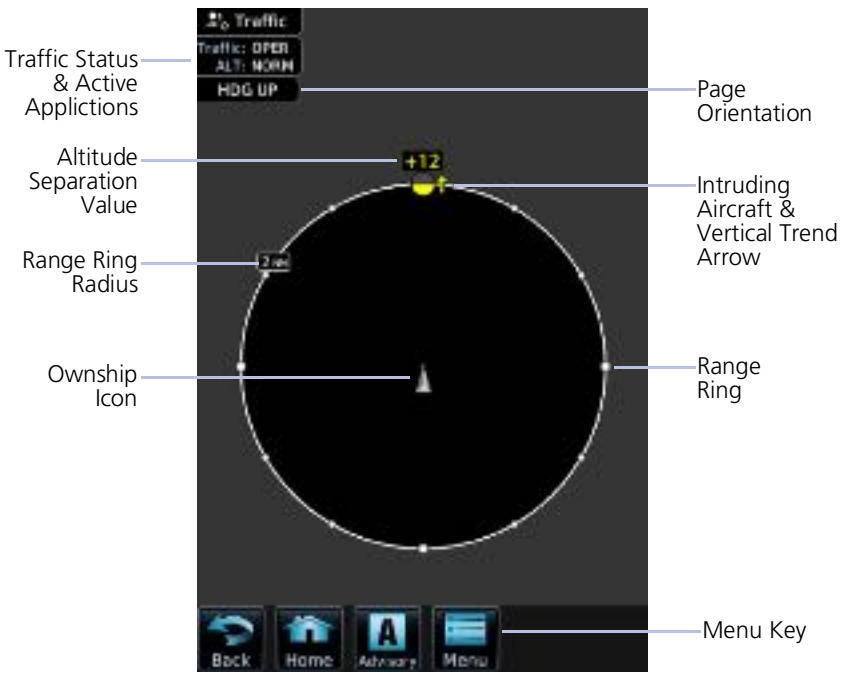

Traffic Page Features

DISPLAY OBJECT	FUNCTION
Ownship Icon	<ul style="list-style-type: none"> • Depicts current aircraft position • Nose of the ownship is the actual ownship location • Unlike the configured aircraft symbol on map displays, ownship icon is always a directional arrow
Page Orientation Label	<p>Orientations:</p> <ol style="list-style-type: none"> 1. Heading up (HDG UP) during normal operation. 2. Track up (TRK UP) if there is no valid heading.
Range Rings	<ul style="list-style-type: none"> • Ranges vary according to traffic system type • Outer ring represents selected range
Altitude Separation Value	<p>Indicates when an intruder is above or below the ownship. Value placement is based on intruder location.</p> <ul style="list-style-type: none"> • Above traffic symbol if intruder is above • Below symbol if intruder is below • Plus or minus sign denotes higher or lower altitude
Vertical Trend Arrow	<ul style="list-style-type: none"> • Active when an intruder is climbing or descending at a vertical speed greater than 500 fpm
Intruding Aircraft Symbol	<p>Color may be cyan or white depending on configuration. Actual intruder location varies according to symbol type.</p> <ul style="list-style-type: none"> • Tip of directional symbols • Center of non-directional symbols

INVALID ALTITUDE DEPICTIONS





If an intruder does not have a valid altitude, its symbol displays without the altitude tag.

OFF SCALE TRAFFIC ALERTS



Off scale (out of range) traffic alerts are depicted as half yellow symbols on the outermost range ring at the correct bearing.

TRAFFIC OVERLAY STATUS ICONS

ICON	DESCRIPTION
	Map is displaying traffic.
	Map is not displaying traffic.

Overlay icons indicate the status of displayed traffic on HSI Map, Rotorcraft PFD VFR Map, and the MFD Map page.

TRAFFIC UNITS

PARAMETER	UNITS
Altitude	ft
Distance	nm

Traffic units are always uniform.

System Units page selections do not affect the traffic display.



If the system units for altitude are set to meters, an annunciation reminds the pilot that all displayed altitude values remain in feet.

6.2 Traffic Setup

Traffic settings are synchronized between all MFDs.

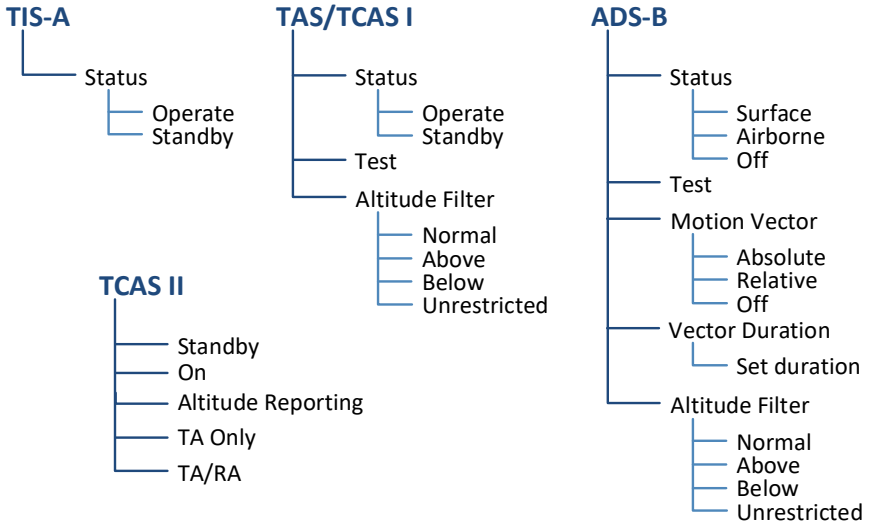

6.2.1 Traffic Test

FEATURE LIMITATIONS

- ADS-B, TAS, and TCAS applications only
- Available only when the aircraft is on ground (i.e., standby mode)
- Test pattern depiction is dependent upon the active traffic system

TEST KEY



The test function displays a test pattern on the Traffic page. For ADS-B, this option is accessible via the Traffic menu.

The system automatically returns to normal operating mode once the test is complete.

6.2.2 Altitude Filtering

FEATURE LIMITATIONS

- ADS-B, TAS, and TCAS applications only

Pilot selectable filters limit the display of traffic to a specific altitude range relative to the altitude of the ownship.

Filter selections apply to both the Traffic page and the traffic overlay on the Map page.

SELECTION	ALTITUDE RANGE
Normal	-2,700 ft to 2,700 ft
Above	-2,700 ft to 9,900 ft
Below	-9,900 ft to 2,700 ft
Unrestricted	-9,900 ft to 9,900 ft

On a standalone PFD, HSI Map always presents traffic at the Normal filter setting. On GDU 1060 with PFD and MFD, it uses the same filter selections on MFD.

Traffic Types

6.3 TIS-A

FEATURE REQUIREMENTS

- Aircraft location is within the service volume of a Mode S terminal radar site
- TIS-capable Mode S transponder is interfaced to the GDU

FEATURE LIMITATIONS

For information about TIS-A functions and limitations, consult the AIM.

TIS-A Features

- 2-D graphical depiction of proximate traffic based on data received from terminal radars
- Track vector depicts intruder trajectory over the ground
- Vertical coverage: +3,500/ -3,000 ft from ownship
- Eight intruder maximum within an 8 nm radius
- Five second update cycle
- Normal and standby mode options

6.3.1 TIS-A Setup Selections

SELECTION	FUNCTION
Status	Select operating mode. Options are Operate and Standby.

6.3.2 TIS-A Traffic Symbols

Traffic information is for advisory use only. The pilot is responsible for identifying and avoiding traffic.



Non-threat Traffic



Traffic Advisory (TA)



TA Off-scale

6.3.3 TIS-A Status Indications

ANNUNCIATION	DESCRIPTION
Data Failed	GDU receives data from the transponder, but a failure exists in the data stream.
Failed	Transponder failure.
No Data	GDU is not receiving valid data from the transponder.
TA X.X NM \pm XX \updownarrow	System cannot determine TA bearing. Intruder depiction not available. Annunciation includes: <ul style="list-style-type: none"> Distance in nautical miles Altitude separation in hundreds of feet Altitude trend arrow (climbing/descending)
TA OFF SCALE	TA is outside the selected display range.
Traffic Coast x SEC	Intruder depictions are more than six seconds old.
Traffic Removed	Intruder depictions are more than 12 seconds old. Traffic symbols no longer display.
Unavailable	Transponder not receiving TIS-A data from ground station.

6.4 TAS/TCAS I

TAS/TCAS I Features

- Airborne traffic system independent of ground radar
- 2-D graphical depiction of traffic relative to aircraft position and altitude

6.4.1 TAS/TCAS I Setup Selections

SELECTION	FUNCTION
Status	Select operating mode. Options are Operate and Standby.
Test	Initiate a test of the traffic system.
Altitude Filter	Select filter range. Options include: <ul style="list-style-type: none"> • Normal • Above • Below • Unrestricted

6.4.2 TAS/TCAS I Traffic Symbols

Traffic information is for advisory use only. The pilot is responsible for identifying and avoiding traffic conflict.



Other Traffic



Proximity Advisory



Traffic Advisory



TA Off-scale

6.4.3 TAS/TCAS I Status Indications

ANNUNCIATION	DESCRIPTION
Data Failed	GDU receives traffic data, but the TAS unit is reporting a failure.
Failed	Traffic data failure.
No Data	GDU is not receiving valid data from the TAS unit.
TA X.X NM \pm XX \updownarrow	<p>System cannot determine TA bearing. Intruder depiction not available. Annunciation includes:</p> <ul style="list-style-type: none"> • Distance in nautical miles • Altitude separation in hundreds of feet • Altitude trend arrow (climbing/descending)

6.5 TCAS II



WARNING

TRAFFIC INFORMATION SHOWN ON SYSTEM DISPLAYS IS PROVIDED AS AN AID IN VISUALLY ACQUIRING TRAFFIC. TRAFFIC AVOIDANCE MANEUVERS ARE BASED UPON TCAS II RESOLUTION ADVISORIES, ATC GUIDANCE, OR POSITIVE VISUAL ACQUISITION OF CONFLICTING TRAFFIC.



NOTE

If the installed TCAS II traffic system is not a GTS 8000, refer to the applicable documentation for system-specific information.

FEATURE REQUIREMENTS

- GTS 8000 or third-party TCAS II system

TCAS II Features

- Monitors nearby airspace for aircraft flying with operating transponders
- Issues TAs to assist in visual identification of traffic
- Issues RAs to provide recommended vertical guidance maneuvers to resolve traffic conflicts

6.5.1 TCAS II Status Indications

SELECTION	MFD TRAFFIC PAGE TCAS STATUS
TCAS II Self-Test Initiated (TEST)	TEST
Traffic and Resolution Advisory (TA/RA)	TA/RA
Traffic Advisory Only	TA ONLY
TCAS II Standby	STBY
TCAS II Failed	FAIL



TCAS II status is shown in the MFD Traffic page data block.

6.5.2 TCAS II Annunciations

SELECTION	PFD ANNUNCIATIONS
TCAS II Self-Test Initiated (TEST)	TCAS TEST
Traffic Advisory Only	TA ONLY
TCAS II Standby	TCAS STBY
TCAS II Failed	TCAS FAIL
TCAS Resolution Advisories Unavailable	TCAS VS RA FAIL
Traffic and Resolution Advisory (TA/RA)	TRAFFIC
RA Display Unavailable (Expand the PFD display area to resolve)	VS RA N/A

TCAS annunciations will appear on the right side of the PFD. Information annunciations are in black text on white backgrounds. Caution annunciations are in black text with yellow backgrounds. Warning annunciations are in white text with red backgrounds.

When the TCAS II unit issues a TA or RA, "TRAFFIC" appears and flashes for 5 seconds, and remains until no TAs or RAs are detected.

- RA "TRAFFIC" annunciations are white text with red backgrounds
- TA "TRAFFIC" annunciations are black text with yellow backgrounds
- If a TA and RA occur simultaneously, only the red and white RA "TRAFFIC" annunciation displays

If the GDU is not displaying the Traffic page, the system displays a traffic alert pop-up.

- During a TA event, the system issues a single "Traffic, Traffic" voice alert each time the system detects a new TA threat
- During an RA event, voice alert(s) provide vertical guidance to resolve the traffic conflict
 - The VSI displays a range of vertical speeds to fly to or avoid as applicable
 - Additional voice alerts occur if the RA status changes and when the aircraft is clear of the conflict

TRAFFIC ALERT BANNER

If the traffic system cannot determine the bearing of a traffic or RA, the alert displays as a traffic alert banner.

RA X.X ± XX <UP> OR <DN>

Warning Banner

- Displays when the system is unable to determine the bearing of an RA and extreme pilot vigilance is required
 - Banner indicates distance in nm and altitude separation in hundreds of feet
 - If altitude trend is available, the banner indicates altitude trend up <UP> for climbing and down <DN> for descending traffic
-

TA X.X ± XX <UP> OR <DN>

Caution Banner

- Displays when the system is unable to determine the bearing of a TA and pilot vigilance is required
 - Banner indicates distance in nm and altitude separation in hundreds of feet
 - If altitude trend is available, the banner indicates altitude trend up <UP> for climbing and down <DN> for descending traffic
-

6.5.3 TCAS II Traffic Symbols

Traffic information is for advisory use only. The pilot is responsible for identifying and avoiding traffic conflict. TCAS II categorizes detected traffic into four groups of increasing collision threat potential. Lowest threat is OT and the highest is RA.



OT

Other non-threatening traffic.



PA

Traffic is not currently a threat, but is within 6 nm and $\pm 1,200$ ft of the own-aircraft altitude.



TA

Indicates traffic is within 20-48 seconds of a potential collision area.



Off-scale TA

Traffic is beyond the selected map range and the system displays a half-TA symbol at the edge of the map at the approximate relative bearing of the TA traffic. If TA traffic subsequently meets the criteria for an RA, the system issues an RA.



RA

Indicates traffic is within 15-35 seconds of a potential collision area.



Off-scale RA

If RA traffic is beyond the selected map range, the system displays a half-RA symbol at the edge of the map positioned at the approximate relative bearing to the RA traffic.

6.5.4 TCAS II with ADS-B



NOTE

Aircraft that are surveilled by ADS-B In only will not trigger a TCAS resolution advisory.

TCAS II interrogates Mode-S transponder data while automatically receiving ADS-B position and velocity information directly from a comparably equipped aircraft target. For preciseness, the system correlates between two data sources and the system displays the traffic information for the source determined to be the most accurate. Traffic that is not correlated (i.e., only detected by one system but not the other) is also displays for the flight crew. This may occur, for example, if another aircraft is beyond the surveillance range of the TCAS II, but it is still receiving position and velocity information from other ADS-B equipped aircraft. The traffic correlation feature improves the accuracy of the traffic displayed, while reducing the occurrence of displaying a single target twice.

6.6 ADS-B

ADS-B Features

















- Runway and taxiway depiction during SURF mode (< 2 nm range scale)
- Selectable traffic icons display intruder and vector information
- Customizable motion vectors (type, duration)
- Airborne and surface mode options
- On-scene mode option (rotorcraft only)

6.6.1 ADS-B Setup Selections

SELECTION	FUNCTION
ADS-B Status	Enable automatic mode selection. System selects between Surface and Airborne depending on the state of the aircraft. Selecting Off disables the function.
Test	Initiate a test of the traffic system.
Motion Vector	Select motion vector type. Selecting Off removes all motion vectors from the display. <ul style="list-style-type: none"> • Absolute • Relative • Off
Vector Duration	Select the amount of time represented by the endpoint. Options range from 0 seconds to 5 minutes. A longer duration results in a longer vector.
Altitude Filter	Select filter range. Options include: <ul style="list-style-type: none"> • Normal • Above • Below • Unrestricted

6.6.2 ADS-B Traffic Symbols

Traffic Information is for advisory use only. The pilot is responsible for identifying and avoiding traffic conflict.

	Basic Directional		Proximate Directional
	Basic Non-directional		Proximate Non-directional
	Basic Off-scale Selected		Proximate Off-scale Selected
	Directional (On-Ground)		Non-directional Alerted
	Non-directional (On-Ground)		Off-scale Non-directional Alerted Traffic
	Proximate Directional (On-Ground)		Directional Alerted Traffic
	Proximate Non-directional (On-Ground)		Off-scale Directional Alerted Traffic
	Directional Surface Vehicle		Non-directional Surface Vehicle

6.6.3 ADS-B Traffic Applications

FEATURE LIMITATIONS

- On-scene mode functionality is available only for rotorcraft

MODE	FEATURES
AIRB	<ul style="list-style-type: none"> • Airborne traffic application • Active in the en route environment (>5 nm and >1,500 ft above the nearest airport)
SURF	<ul style="list-style-type: none"> • Airborne and ground traffic application • Active on ground or within the terminal environment (<5 nm and <1,500 ft above field elevation) • Runway and taxiway depictions when the zoom scale is <2 nm (Traffic page only) • Ground vehicle depictions
On-scene	<ul style="list-style-type: none"> • Rotorcraft nuisance alert suppression option • Reduces alerts caused by proximity rotorcraft operating in a scene environment (e.g., EMS landing zone, news gathering events) • Mode activation and control by way of navigator • Look-ahead time: 3 seconds • Traffic alarm vertical threshold: 200 ft • Incremental protected traffic volume: 1,000 ft

6.6.4 Motion Vectors

FEATURE LIMITATIONS

- Motion vectors display on the Traffic page only

A motion vector is a line extending from the nose of an intruder icon. Its orientation represents the intruder's direction and movement. A yellow vector indicates when traffic meets intruding TA criteria (i.e., closing rate, distance, vertical separation).

MOTION VECTOR TYPES	
Absolute	<ul style="list-style-type: none"> • Cyan or white vector depending on configuration • Depicts intruder ground track • Calculations based on intruder direction and ground speed • Endpoint depicts intruder's position over the ground at the end of the selected duration • Airborne and ground functionality
Relative	<ul style="list-style-type: none"> • Green vector • Depicts intruder movement relative to the ownship • Calculations based on track and ground speed of both intruder and ownship • Endpoint depicts intruder's location relative to the ownship at the end of the selected duration • Airborne functionality only • "Relative Motion - Unavailable" annunciates during ground operations

6.6.5 ADS-B Status Indications

ANNUNCIATION	DESCRIPTION
Absolute Motion - XX SEC/MIN	Active motion vector type is absolute.
Failed	ADS data failure.
No Data	GDU is not receiving valid traffic data.
No GPS Position	ADS-B LRU detects that GPS unit is initializing.
Relative Motion - XX SEC/MIN	Active motion vector type is relative.
Relative Motion - UNAVAILABLE	Aircraft is not airborne and the active motion vector type is relative.
Unavailable	Necessary traffic data not available.

6.6.6 ADS-B Traffic Interactions

Selected Traffic Information

- Registration/call sign
- Vehicle type
- Closure rate
- Track
- Ground speed
- AIRB/SURF eligibility

Selecting a traffic symbol displays information about the aircraft in the upper right corner of the page.

Selections remain active through altitude filtering, zoom scale, and page changes.

Tapping **Next** repeatedly steps through multiple symbols spaced closely together.

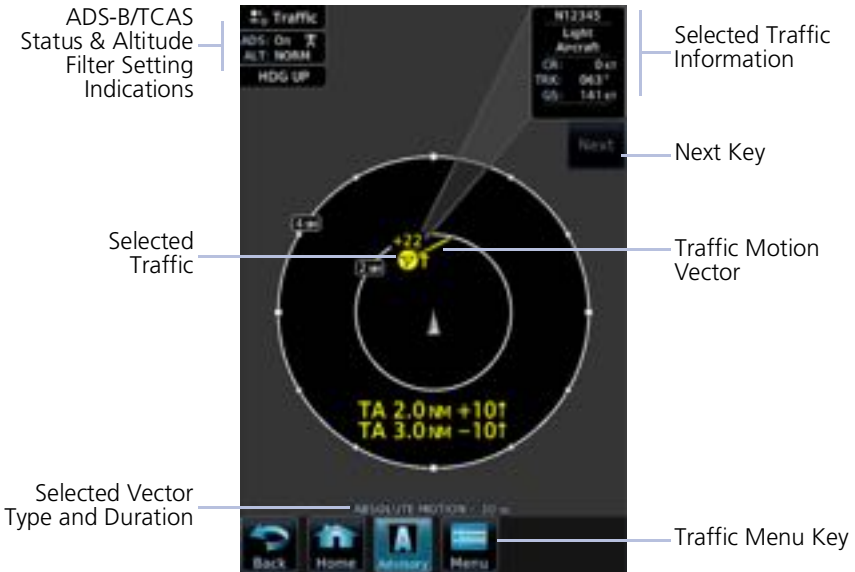

ADS-B Traffic Features

6.7 Traffic Alerts

Traffic alerts occur anytime there is an increase in the number of traffic advisories. They remain active until the area is clear of all TAs.



MFD Pop-up

Traffic alerts appear as textual annunciations on the PFD, and as a pop-up window on the MFD, when applicable.

Aural traffic alerts are not a function of the GDU.



PFD Annunciation

ANNUNCIATION	ALERT TYPE, POP-UP, CONDITIONS, & VOICE MESSAGE	
TRAFFIC	Alert Type: Caution Pop-up Alert: Yes	
	Condition The traffic system reports a traffic advisory.	Voice Message Message content depends on current traffic system configuration.

INTENTIONALLY LEFT BLANK

7 Terrain Awareness

TERRAIN CONFIGURATIONS

7.1	GPS Altitude for Terrain	7-2
7.2	Database Limitations	7-4

TERRAIN DISPLAY

7.3	Terrain Page	7-5
7.4	Terrain Setup	7-7
7.5	Terrain Proximity	7-8

TERRAIN ALERTING

7.6	Alert Types	7-13
7.7	Terrain-FLTA	7-19
7.8	TAWS-B	7-23
7.9	External TAWS/HTAWS	7-27

Terrain Configurations

Available Terrain Configurations

- (H)Terrain Proximity
- (H)Terrain-FLTA
- TAWS-B
- External TAWS/HTAWS
- TAWS-A

Terrain, obstacle, and wire data display as overlays on the Terrain page, Map page, and HSI Map. Alerting functions are dependent upon the aircraft type and configured terrain alerting options.

Terrain controls are accessible from the Terrain menu. Map overlay keys are accessible from the associated map menu.

EXTERNAL TAWS

Depending on system configuration, the GDU may be capable of remotely indicating TAWS information from the navigator.

7.1 GPS Altitude for Terrain

FUNCTIONAL REQUIREMENTS

GPS altitude is derived from satellite measurements. To acquire an accurate 3-D fix (latitude, longitude, altitude), a minimum of four operating satellites must be in view of the GPS receiver antenna.

The terrain system uses GPS altitude and position data to:

- Create a 2-D image of surrounding terrain and obstacles relative to the aircraft's position and altitude
- Calculate the aircraft's flight path in relation to surrounding terrain and obstacles
- Predict hazardous terrain conditions and issue alerts

7.1.1 GSL Altitude & Indicated Altitude

The GDU converts GPS altitude data to GSL altitude (i.e., the geometric altitude relative to MSL) for use in terrain functions. All Terrain page depictions and elevation indications are in GSL.

Variations between GSL altitude and the aircraft's corrected barometric altitude (or indicated altitude) are common. As a result, Terrain page altitude data may differ from current altimeter readings. Both GSL altitude and indicated altitude represent height above MSL, but differ in accuracy and reliability.

GSL Altitude

- Highly accurate and reliable geometric altitude source
- Does not require local altimeter settings to determine height above MSL
- Not subject to pressure and temperature variations
- Affected primarily by satellite geometry

Indicated Altitude

- Barometric altitude source corrected for pressure variations
- Requires frequent altimeter setting adjustment to determine height above MSL
- Subject to local atmospheric conditions
- Affected by variations in pressure, temperature, and lapse rate

7.2 Database Limitations



NOTE

Garmin cross-validates terrain and obstacle data in accordance with TSO-C151c. However, the information should never be considered all-inclusive. Database inaccuracies or omissions may exist.

Terrain and obstacle data are not available when the aircraft is operating outside of the installed database coverage area.

Garmin obtains terrain and obstacle data from government sources and cannot independently verify the accuracy and completeness of the information. Pilots must familiarize themselves with the appropriate charts and other data for safe flight.

DATABASE	COVERAGE LIMITATIONS
Terrain	<ul style="list-style-type: none"> • Not available north of 89° N latitude and south of 89° S latitude
Obstacle	<ul style="list-style-type: none"> • Coverage areas vary according to database type • Power line indications for the contiguous United States and small parts of Canada and Mexico • Regional definitions may change without notice • May not contain uncharted obstacles • May include power lines or only HOT lines depending on database type [1]

[1] HOT lines are power lines that share location with other obstacles identified by the FAA.

Terrain Display



Unlike the Map page and HSI Map, the Terrain page does not provide controls for toggling overlays on or off.

7.3 Terrain Page



WARNING

DO NOT USE TERRAIN AND OBSTACLE DATA TO NAVIGATE OR MANEUVER AROUND TERRAIN. THEY ARE AN AID TO SITUATIONAL AWARENESS ONLY.



FEATURE REQUIREMENTS

All terrain functions require the following components to operate properly.

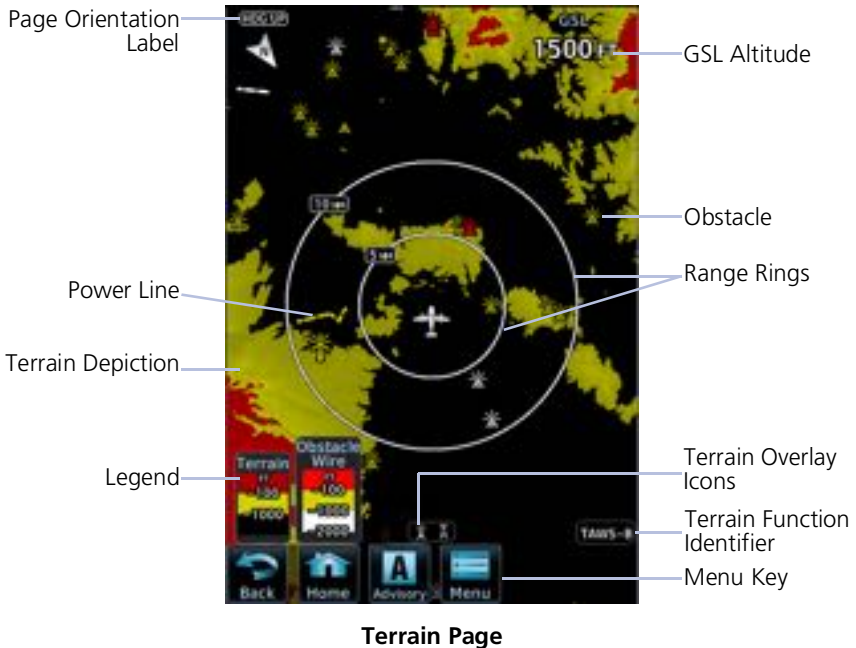
- Valid 3-D GPS position for terrain and obstacle data display
- Valid terrain/obstacle database

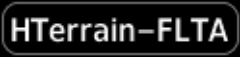

Terrain Page

DISPLAY OBJECT	FUNCTION
Page Orientation Label	Normally, Heading Up orientation. Changes to Track Up in the event of a heading failure.
GSL Altitude	Displays current GPS height above mean sea level. Pilot selectable units are available on the System Units page.
Legend	Displays color designations for terrain and obstacle relative altitude ranges.
Terrain Function Identifier	Indicates the active terrain function. Includes:  TAWS-A, TAWS-B, (H)Terrain-FLTA, Terrain Proximity
Terrain Overlay Icon	Indicates when power lines or obstacles are present at the current zoom scale.  Automatic removal of obstacle and power line data occurs at range scales greater than 10 nm.
Menu Key	Provides access to pilot selectable settings, self-test, and alert inhibit functions.

AUTOMATIC ZOOM



In the event an alert occurs, the page automatically zooms to provide the best depiction of that alerted terrain, obstacle, or power line.

7.4 Terrain Setup

Terrain Page Menu

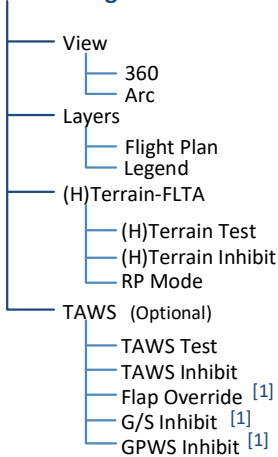

[1] TAWS-A only.

Tap **Menu** to access pilot selectable terrain settings, including self test and alert inhibit functions.

SELECTION		FUNCTION
View	360	<ul style="list-style-type: none"> Changes view format to a 360° ring encircling the aircraft (default view)
	Arc	<ul style="list-style-type: none"> Changes view format to a forward-looking 120° arc
Layers	Flight Plan	<ul style="list-style-type: none"> Toggles the active flight plan display over terrain map on or off
	Legend	<ul style="list-style-type: none"> Toggles the Terrain and Obstacle/Wire legend on or off
(H)Terrain FLTA	(H)Terrain Test	<ul style="list-style-type: none"> Performs terrain alerting system test Verifies the validity of required databases
	(H)Terrain Inhibit	<ul style="list-style-type: none"> Inhibits the FLTA aural and visual alerts
	RP Mode [1]	<ul style="list-style-type: none"> Reduces alerting thresholds for low-level operations

SELECTION		FUNCTION
TAWS-A	Flap Override	<ul style="list-style-type: none"> • Overrides flap-based FIT alerting while other FIT alert functions remain in effect • Inhibits nuisance FIT alerts where flap extension is not desired
	G/S Inhibit	<ul style="list-style-type: none"> • Inhibits glideslope or glidepath alerts depending on current state • Use to prevent glideslope/glidepath deviation alerts (e.g., when flying a localizer backcourse approach) • Active only for a single approach
	GPWS Inhibit	<ul style="list-style-type: none"> • Inhibits GPWS audible and visual alerts (i.e., EDR, ECR, FIT, and NCR)
TAWS-A & B	TAWS Test	<ul style="list-style-type: none"> • Performs TAWS alerting system test • Verifies the validity of required databases
	TAWS Inhibit	<ul style="list-style-type: none"> • Inhibits the PDA/FLTA audible and visual alerts

[1] Rotorcraft only.

7.5 Terrain Proximity

FEATURE LIMITATIONS

- Terrain and obstacle depictions are relative to aircraft altitude
- Obstacle depictions are dependent upon database
- Setup does not provide visual or aural alerts

Terrain Proximity Features

- Non-TSO C151c certified terrain display system
- 2-D graphical representation of surrounding terrain, obstacles, and power lines relative to aircraft position and altitude
- Declutter automatically removes obstacle and power line data at large ranges
- Continuous monitoring of database validity, GPS and hardware status
- Displays when higher level terrain functions are active

7.5.1 Terrain Elevation Depictions

Color shading depicts terrain elevations relative to the aircraft's position and altitude. Colors automatically adjust as the aircraft's altitude changes.

TERRAIN DEPICTIONS, FIXED WING

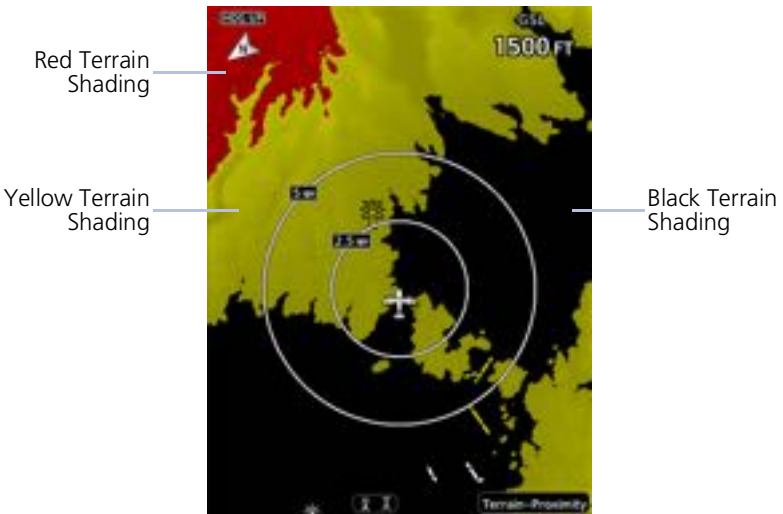
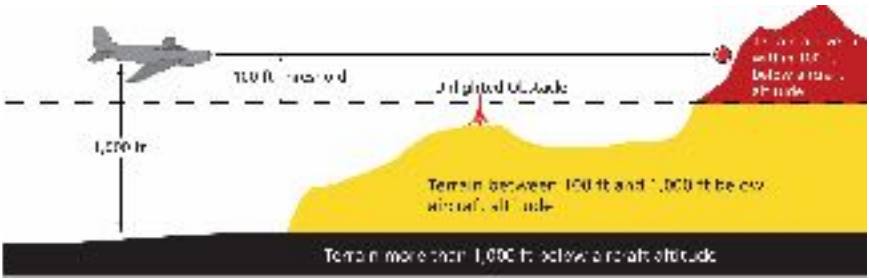



TERRAIN DEPICTIONS, ROTORCRAFT

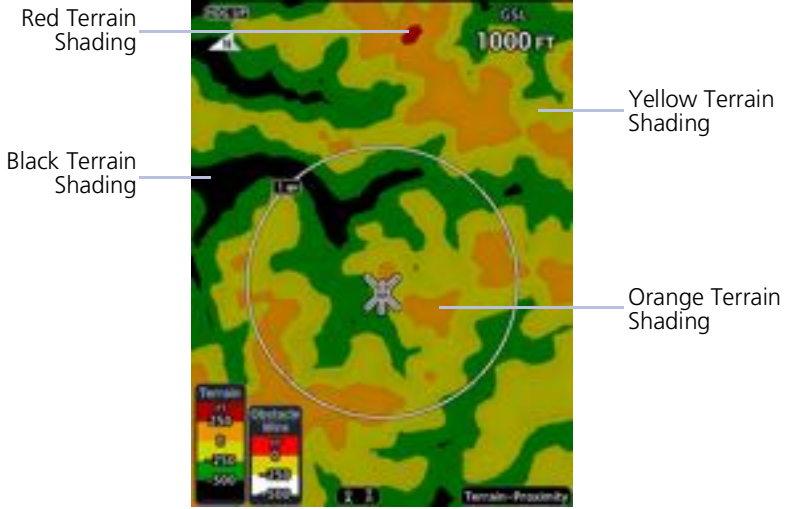
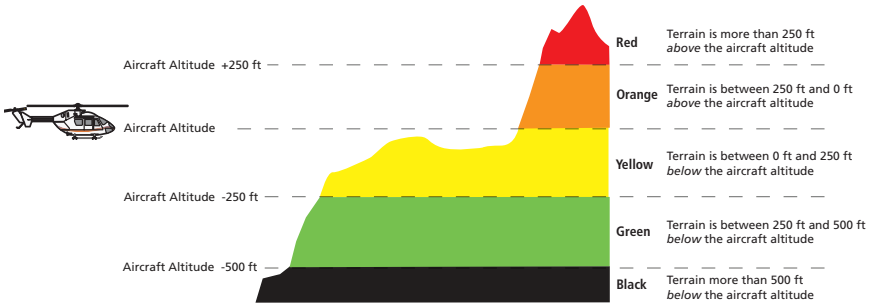

7.5.2 Obstacle Elevation Depictions

FEATURE LIMITATIONS

- Fixed wing aircraft: obstacles more than 2,000 ft below current altitude do not display
- Rotorcraft: obstacles more than 500 ft below current altitude do not display
- Power line depictions in synthetic vision are currently not available



TOWER OBSTACLES

UNLIGHTED OBSTACLE		LIGHTED OBSTACLE		OBSTACLE LOCATION	
<1,000' AGL	>1,000' AGL	<1,000' AGL	>1,000' AGL	FIXED WING	ROTORCRAFT
				Red obstacle is above or within 100 ft below current altitude.	Red obstacle is at or above current altitude.
				Yellow obstacle is between 100 ft and 1,000 ft below current altitude.	Yellow obstacle is within 250 ft below current altitude.
				White obstacle is between 1,000 ft and 2,000 ft below current altitude.	White obstacle more than 250 ft below current altitude.

WIND TURBINE OBSTACLES

UNLIGHTED WIND TURBINE OBSTACLE	LIGHTED WIND TURBINE OBSTACLE	WIND TURBINE OBSTACLE LOCATION	
		FIXED WING	ROTORCRAFT
		Red obstacle is above or within 100 ft below current altitude.	Red obstacle is at or above current altitude.
		Yellow obstacle is between 100 ft and 1,000 ft below current altitude.	Yellow obstacle is within 250 ft below current altitude.
		White obstacle is more than 1,000 ft below current altitude.	White obstacle more than 250 ft below current altitude.

POWER LINE OBSTACLES

OBSTACLE	POWER LINE OBSTACLE LOCATION
	Red power line is above or within 100 ft below current altitude.
	Yellow power line is between 100 ft and 1,000 ft below current altitude.
	White power line is between 1,000 ft and 2,000 ft below current altitude.

OBSTACLE GROUPS

With the exception of power lines, obstacles within close proximity of each other may display as a group.



- Asterisk indicates that the obstacle belongs to a group
- Relative altitude of the highest obstacle determines color
- Depiction is of the most immediate threat

Terrain Alerting

The behavior of an alerting function is determined at installation. Installer configurable settings allow:

- Alert suppression for specific runway types
- Gender selection for voice messages
- Volume level

7.6 Alert Types

TERRAIN-FLTA
<ul style="list-style-type: none"> • Imminent Impact • Reduced Clearance
TAWS-A
<ul style="list-style-type: none"> • Imminent Impact • Reduced Clearance • Premature Descent • Excessive Descent Rate • Excessive Closure Rate • Negative Climb Rate • Flight Into Terrain • Excessive Below Glideslope/Glidepath Deviation
TAWS-B
<ul style="list-style-type: none"> • Imminent Impact • Reduced Clearance • Premature Descent • Excessive Descent Rate • Negative Climb Rate

Available alerting functions depend on the installed terrain system.

ALERT TYPE	CONDITION
Imminent Impact [1]	Aircraft reaches the minimum clearance altitude of any obstacle (IOI), terrain (ITI), or power line (ILI) in the projected flight path.
Reduced Clearance [1]	Aircraft's vertical flight path is projected to be within the minimum clearance altitude of an obstacle (ROC), terrain (RTC), or power line (RLC).
Premature Descent [2]	Aircraft is significantly below the normal approach path for the nearest runway. <ul style="list-style-type: none"> • Altitude is <700 ft above terrain • Distance from destination airport is 15 nm or less
Excessive Descent Rate	Aircraft descends toward terrain at an excessive rate.
Excessive Closure Rate [3]	Aircraft closes upon terrain at a rate excessive for gear and flaps in the landing configuration.
Negative Climb Rate	Aircraft loses altitude following takeoff. <ul style="list-style-type: none"> • Altitude is <700 ft above terrain • Distance from departure airport is 2 nm or less • Deviation from departure heading is <110°
Flight Into Terrain	Aircraft is too low with respect to terrain. Based on landing gear status, flap position, and ground speed.
Excessive Below Glideslope or Glidepath Deviation	Aircraft is significantly below the glidepath for the selected approach. Active only after departure and when the following conditions are met. <ul style="list-style-type: none"> • Altitude is <1,000 ft AGL • Gear is configured for landing • ILS, LPV, LNAV/VNAV, or LNAV+V approach is active and the unit is indicating vertical navigation

- [1] Alerting inhibited <200 ft AGL within 0.5 nm of approach runway or <125 ft AGL within 1.0 nm of runway threshold.
- [2] Alerting inhibited within 0.5 nm of approach runway or <125 ft AGL within 1.0 nm of runway threshold. Alerting thresholds for final descent are based on current position, speed, and flight path data.
- [3] Alerting inhibited within 5 nm of nearest airport, except when FLTA is not available. In such cases, "TAWS N/A or TAWS FAIL annunciates and ECR alerting remains active until landing.

7.6.1 Alerting Thresholds

FLIGHT PHASE	MINIMUM CLEARANCE ALTITUDE	
	LEVEL FLIGHT	DESCENDING
En Route	700 ft	500 ft
Terminal	350 ft	300 ft
Approach	150 ft	100 ft
Departure	100 ft	100 ft

EDR THRESHOLDS

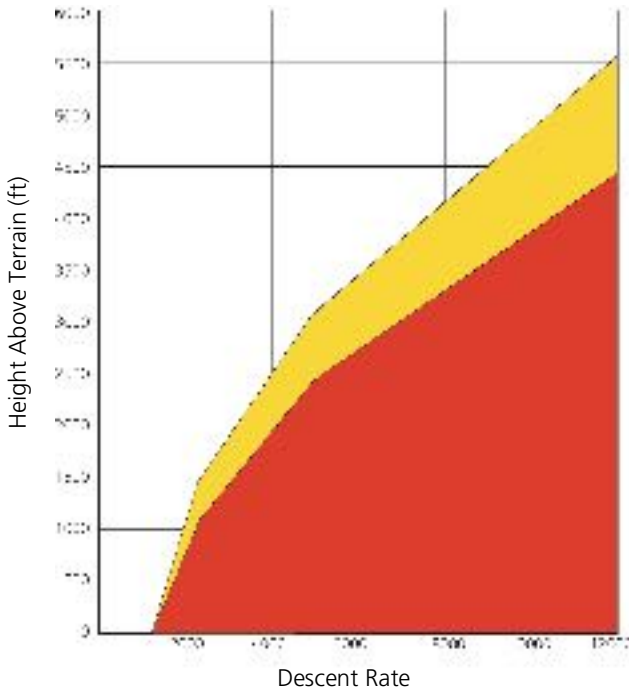

Sink Rate ■ "Pull Up" ■

PDA THRESHOLD

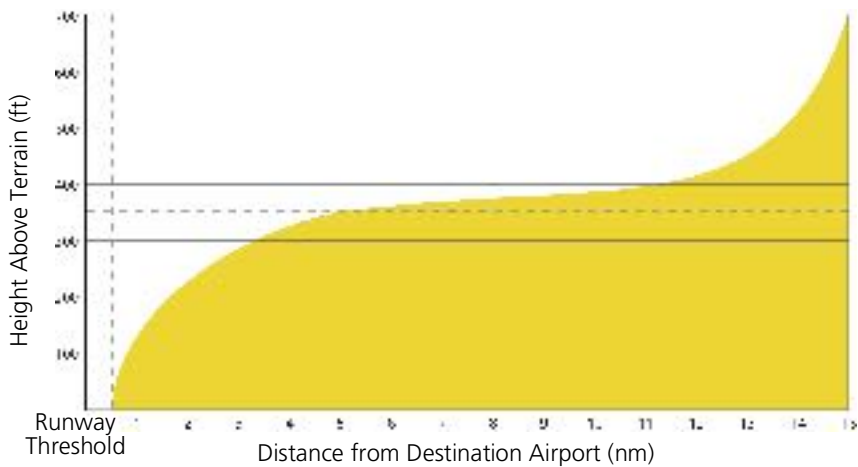

Alerting Area

NCR THRESHOLDS

Alert triggers: altitude loss, sink rate

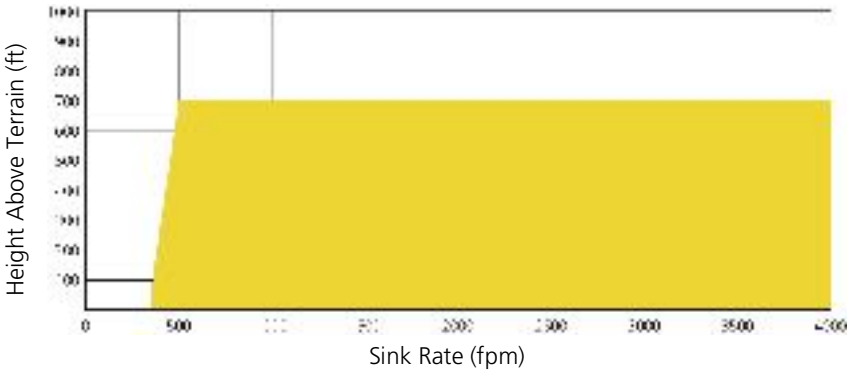
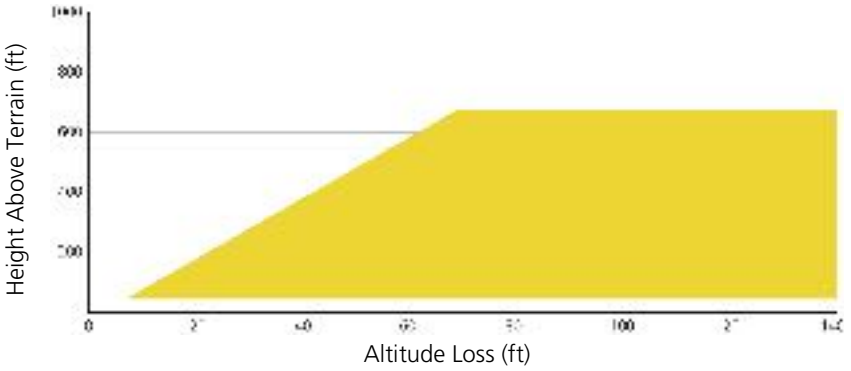

"Don't Sink"

7.6.2 Alert Inhibit, TAWS and Terrain-FLTA



The **Terrain Inhibit** control is accessible via the terrain pop-up alert or Terrain page menu.



NOTE

Always use discretion when inhibiting TAWS or Terrain-FLTA alerts. Re-activate the alert function when appropriate.

TERRAIN INHIBIT FUNCTIONS	
INHIBIT	Manually inhibits TAWS or Terrain-FLTA aural and visual alerts for low altitude approaches or rotorcraft operation.
AUTOMATIC INHIBIT	Automatically inhibits TAWS and Terrain-FLTA alerts when the aircraft meets the following approach criteria. <ul style="list-style-type: none"> TAWS: <ul style="list-style-type: none"> • GPS/SBAS approach • Position inside FAF TAWS & TERRAIN-FLTA: <ul style="list-style-type: none"> • Altitude <200 ft above runway elevation • Position <0.5 nm of approach end or between each runway end

TAWS-A INHIBIT ANNUNCIATIONS



Terrain Page Annunciations

TAWS-A alert inhibit annunciations appear at the bottom right of the display.

“FLAP OVRD” does not annunciate if GPWS Inhibit is already active, as both functions inhibit FIT alerts.

A plus sign indicates multiple alerts.

TAWS INHB+

7.7 Terrain-FLTA

Terrain-FLTA Features

- Non-TSO C151c certified terrain alerting system
- Aural and visual alerts for potential flight path conflicts involving terrain, obstacles, or power lines
- FLTA functions: RTC, RLC, ROC, ITI, ILI, and IOI
- Terrain depictions and display overlays
- Cautions and warnings indicate alert severity and threat type
- Textual annunciations on PFD and MFD
- Pop-up alerts on MFD
- Threat location indication on map displays (Map page, HSI Map, Terrain page) and SVT
- Self-test and alert inhibit functionality. FLTA is active whether synthetic vision is on or off
- Reduced protection mode (rotorcraft only)

7.7.1 Reduced Protection Mode, Rotorcraft Only

FEATURE LIMITATIONS

- Rotorcraft only
- Alerting times are significantly less than during normal operating mode

During reduced protection mode, alerting times are significantly less than during normal operating mode. Use this function only when terrain is within sight.

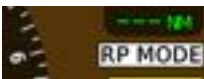

PFD Annunciation

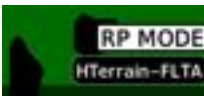

MFD Annunciation

- Allows rotorcraft-configured systems to operate using reduced terrain alerting system thresholds
- Suppresses caution alerts during low level operations and off airport landings while providing warning alert protection from terrain and obstacles

7.7.2 Terrain-FLTA Alerts

ANNUNCIATION	ALERT TYPE, POP-UP, CONDITIONS, & VOICE MESSAGE	
<p>TER FAIL</p>	<p>Alert Type: Caution Pop-up Alert: N/A</p>	
	<p>Condition</p>	<p>Voice Message</p>
	<p>Terrain reports a system failure. The database is missing or corrupt.</p>	<p>“Terrain System Failure”</p>
<p>TER INHB</p>	<p>Alert Type: Advisory Pop-up Alert: N/A</p>	
	<p>Condition</p>	<p>Voice Message</p>
<p>TER N/A</p>	<p>Alert Type: Caution Pop-up Alert: N/A</p>	
	<p>Condition</p>	<p>Voice Message</p>
	<p>No certified GPS position. Degraded GPS signal. Aircraft is outside of the terrain database regional coverage.</p>	<p>“Terrain System Not Available”</p>
<p>Voice Message Only</p>	<p>Alert Type: Advisory Pop-up Alert: N/A</p>	
	<p>Condition</p>	<p>Voice Message</p>
	<p>Terrain system is transitioning from unavailable to available.</p>	<p>“Terrain System Available”</p>

ANNUNCIATION	ALERT TYPE, POP-UP, CONDITIONS, & VOICE MESSAGE	
TERRAIN	Alert Type: Warning Pop-up Alert: Yes	
	Condition	Voice Message
	Reduced Required Terrain Clearance	"Warning, Terrain, Terrain"
	Imminent Terrain Impact	
	Alert Type: Caution Pop-up Alert: Yes	
	Condition	Voice Message
Reduced Required Terrain Clearance	"Caution, Terrain, Terrain"	
Imminent Terrain Impact		
TER TEST	Alert Type: Advisory Pop-up Alert: N/A Condition: Terrain system test is in progress.	
Voice Message Only	Alert Type: Advisory Pop-up Alert: N/A	
	Condition	Voice Message
	Terrain system test is okay.	"Terrain System Test Okay"
OBSTACLE	Alert Type: Warning Pop-up Alert: Yes	
	Condition	Voice Message
	Reduced Obstacle Clearance	"Warning, Obstacle, Obstacle"
	Imminent Obstacle Impact	
	Alert Type: Caution Pop-up Alert: Yes	
	Condition	Voice Message
Reduced Obstacle Clearance	"Caution, Obstacle, Obstacle"	
Imminent Obstacle Impact		

ANNUNCIATION	ALERT TYPE, POP-UP, CONDITIONS, & VOICE MESSAGE	
WIRE	Alert Type: Warning Pop-up Alert: Yes	
	Condition	Voice Message
	Reduced Line Clearance	"Warning, Wire, Wire"
	Imminent Line Impact	
	Alert Type: Caution Pop-up Alert: Yes	
	Condition	Voice Message
	Reduced Line Clearance	"Caution, Wire, Wire"
Imminent Line Impact		

7.8 TAWS-B

FUNCTIONAL REQUIREMENTS

- Valid 3-D GPS position
- TAWS-B feature enablement
- External annunciator for displaying alert information (non-PFD GDUs only)

TAWS-B Features

- Optional TSO C151c Class B terrain alerting system
- All Terrain-FLTA functions plus: premature descent, excessive descent rate, negative climb rate, and altitude voice callout (500 ft) alerts

7.8.1 TAWS-B Alerts

ANNUNCIATION	ALERT TYPE, POP-UP, CONDITIONS, & VOICE MESSAGE	
PULL UP	Alert Type: Warning Pop-up Alert: Yes	
	Condition	Voice Message
	Reduced Required Terrain Clearance	"Terrain, Terrain; Pull Up, Pull Up"
	Imminent Terrain Impact	Or "Terrain Ahead, Pull Up; Terrain Ahead, Pull Up"
	Reduced Obstacle Clearance	"Obstacle, Obstacle; Pull Up, Pull Up"
	Imminent Obstacle Impact	Or "Obstacle Ahead, Pull Up; Obstacle Ahead, Pull Up"
	Reduced Line Clearance	"Wire Ahead, Pull Up; Wire Ahead, Pull Up"
	Imminent Line Impact	Or "Wire, Wire; Pull Up, Pull Up"
	Excessive Descent Rate	"Pull Up"

ANNUNCIATION	ALERT TYPE, POP-UP, CONDITIONS, & VOICE MESSAGE	
TAWS FAIL	Alert Type: Caution Pop-up Alert: N/A	
	Condition	Voice Message
	An internal TAWS-B audio failure exists.	"TAWS System Failure"
	A necessary database is missing or corrupt.	
	Internal terrain alerting configuration is invalid.	
TAWS-B reports a system failure.		
TAWS INHB	Alert Type: Advisory Pop-up Alert: N/A Condition: TAWS-B reports inhibit mode active	
TAWS N/A	Alert Type: Caution Pop-up Alert: N/A	
	Condition	Voice Message
	<p>The GDU is using backup GPS.</p> <p>The navigation solution is degraded or the aircraft is beyond the database coverage area. TAWS-B reports that the system is not available.</p>	"TAWS Not Available"
Voice Message Only	Alert Type: Advisory Pop-up Alert: N/A	
	Condition	Voice Message
	GPS signal integrity returns or the aircraft is back within the database coverage area. TAWS transitions from unavailable to available.	"TAWS Available"

ANNUNCIATION	ALERT TYPE, POP-UP, CONDITIONS, & VOICE MESSAGE	
TAWS TEST	Alert Type: Advisory Pop-up Alert: N/A Condition: TAWS-B system test is in progress	
Voice Message Only	Alert Type: Advisory Pop-up Alert: N/A	
	Condition	Voice Message
Voice Message Only	Internal TAWS-B system test is okay.	"TAWS System Test Okay"
	Alert Type: Advisory Pop-up Alert: N/A	
Voice Message Only	Condition	Voice Message
	Aircraft is descending through 500 ft AGL.	"Five Hundred"
TERRAIN	Alert Type: Caution Pop-up Alert: Yes	
	Condition	Voice Message
	Reduced Required Terrain Clearance	"Caution, Terrain; Caution, Terrain"
	Imminent Terrain Impact	Or "Terrain Ahead; Terrain Ahead"
	Excessive Descent Rate	"Sink Rate"
	Premature Descent Alert	"Too Low, Terrain"
Negative Climb Rate	"Don't Sink" Or "Too Low, Terrain"	

ANNUNCIATION	ALERT TYPE, POP-UP, CONDITIONS, & VOICE MESSAGE	
OBSTACLE	Alert Type: Caution Pop-up Alert: Yes	
	Condition	Voice Message
	Reduced Obstacle Clearance	"Caution, Obstacle; Caution, Obstacle"
	Imminent Obstacle Impact	Or "Obstacle Ahead; Obstacle Ahead"
WIRE	Alert Type: Caution Pop-up Alert: Yes	
	Condition	Voice Message
	Reduced Line Clearance	"Caution, Wire; Caution, Wire"
	Imminent Line Impact	Or "Wire Ahead; Wire Ahead"

7.9 External TAWS/HTAWS

FEATURE REQUIREMENTS

- TAWS/HTAWS function provided by a source external to the GDU

FEATURE LIMITATIONS

- TAWS/HTAWS controls are available only on the external TAWS/HTAWS device

Garmin External TAWS/HTAWS function

- Terrain function relies on an external Garmin GPS device for all TAWS/HTAWS data [1]
- GDU determines terrain map coloration based on the external GPS position and GPS altitude
- **On PFD:** Changes in CDI source selection have no effect on TAWS/HTAWS alerting functions

[1] For more information, refer to the applicable GNS 500W series or GTN series pilot's guide and/or addendum.

TAWS/HTAWS SOURCE	TXI FEATURES
GTN	<ul style="list-style-type: none"> • TAWS/HTAWS alert depictions on the Terrain page, Map page, and in synthetic vision • Terrain depictions and display overlays • Textual annunciations on PFD • Pop-up alerts on MFD
GNS	<ul style="list-style-type: none"> • Terrain depictions and display overlays • Textual annunciations on PFD
Third Party TAWS	<ul style="list-style-type: none"> • GDU display provides only Terrain Proximity functionality

7.9.1 TAWS-A

FUNCTIONAL REQUIREMENTS

- Valid 3-D GPS position
- GTN with TAWS-A feature enablement
- Valid flap and landing gear status inputs into the GTN
- Valid radar altimeter
- External annunciator for displaying alert information (non-PFD GDUs only)

TAWS-A Features

- Optional TSO C151c Class A terrain alerting system
- All Terrain-FLTA functions plus: premature descent, excessive descent rate, negative climb rate, excessive glideslope/glidepath deviation, flap override, flight into terrain, and altitude voice callout (500 ft) alerts
- Terrain depictions and display overlays
- Textual annunciations on PFD
- Pop-up alerts on MFD

On PFD: Changes in CDI source selection have no effect on TAWS alerting functions. For more information, refer to the applicable GTN series pilot's guide.

7.9.2 TAWS-A Alerts

ANNUNCIATION	ALERT TYPE, POP-UP, CONDITIONS, & VOICE MESSAGE	
PULL UP	Alert Type: Warning Pop-up Alert: Yes	
	Condition	Voice Message
	Reduced Required Terrain Clearance	"Terrain, Terrain; Pull Up, Pull Up"
	Imminent Terrain Impact	Or "Terrain Ahead, Pull Up; Terrain Ahead, Pull Up"
	Reduced Obstacle Clearance	"Obstacle, Obstacle; Pull Up, Pull Up"
	Imminent Obstacle Impact	Or "Obstacle Ahead, Pull Up; Obstacle Ahead, Pull Up"
	Reduced Line Clearance	"Wire Ahead, Pull Up; Wire Ahead, Pull Up"
	Imminent Line Impact	Or "Wire, Wire; Pull Up, Pull Up"
	Excessive Descent Rate	"Pull Up"
Excessive Closure Rate		
TAWS FAIL	Alert Type: Caution Pop-up Alert: N/A	
	Condition	Voice Message
	An internal TAWS-A audio failure exists.	"TAWS System Failure"
	A necessary database is missing or corrupt.	
	Internal terrain alerting configuration is invalid.	
TAWS-A reports a system failure.		

ANNUNCIATION	ALERT TYPE, POP-UP, CONDITIONS, & VOICE MESSAGE	
TAWS INHB	Alert Type: Advisory Pop-up Alert: N/A Condition: TAWS-A reports inhibit mode active	
TAWS N/A	Alert Type: Caution Pop-up Alert: N/A	
	Condition	Voice Message
	The GDU is using backup GPS. The navigation solution is degraded or the aircraft is beyond the database coverage area. TAWS-A reports that the system is not available.	"TAWS Not Available"
Voice Message Only	Alert Type: Advisory Pop-up Alert: N/A	
	Condition	Voice Message
	GPS signal integrity returns or the aircraft is back within the database coverage area. TAWS transitions from unavailable to available.	"TAWS Available"
TAWS TEST	Alert Type: Advisory Pop-up Alert: N/A Condition: TAWS-A system test is in progress	
Voice Message Only	Alert Type: Advisory Pop-up Alert: N/A	
	Condition	Voice Message
	Internal TAWS-A system test is okay.	"TAWS System Test Okay"

ANNUNCIATION	ALERT TYPE, POP-UP, CONDITIONS, & VOICE MESSAGE	
Voice Message Only	Alert Type: Advisory Pop-up Alert: N/A	
	Condition	Voice Message
	Aircraft is descending through 500 ft AGL.	"Five Hundred"
TERRAIN	Alert Type: Caution Pop-up Alert: Yes	
	Condition	Voice Message
	Reduced Required Terrain Clearance	"Caution, Terrain; Caution, Terrain"
	Imminent Terrain Impact	Or "Terrain Ahead; Terrain Ahead"
	Excessive Descent Rate	"Sink Rate"
	Excessive Closure Rate	"Terrain, Terrain"
	Flight Into Terrain (High Speed or Takeoff)	"Too Low, Terrain"
	Flight Into Terrain (Flaps)	"Too Low, Flaps"
	Flight Into Terrain (Gear)	"Too Low, Gear"
	Premature Descent Alert	"Too Low, Terrain"
	Negative Climb Rate	"Don't Sink" Or "Too Low, Terrain"

ANNUNCIATION	ALERT TYPE, POP-UP, CONDITIONS, & VOICE MESSAGE	
OBSTACLE	Alert Type: Caution Pop-up Alert: Yes	
	Condition	Voice Message
	Reduced Obstacle Clearance	"Caution, Obstacle; Caution, Obstacle"
	Imminent Obstacle Impact	Or "Obstacle Ahead; Obstacle Ahead"
WIRE	Alert Type: Caution Pop-up Alert: Yes	
	Condition	Voice Message
	Reduced Line Clearance	"Caution, Wire; Caution, Wire"
	Imminent Line Impact	Or "Wire Ahead; Wire Ahead"
GLIDESLOPE	Alert Type: Caution Pop-up Alert: Yes	
	Condition	Voice Message
	Glideslope Deviation	"Glideslope"
GPWS FAIL	Alert Type: Caution Pop-up Alert: N/A	
	Condition	Voice Message
	Incorrect TAWS configuration	"GPWS System Failure"
	Radar altimeter unavailable	
	GPS position unavailable or degraded	
Internal TAWS-A audio failure exists		

ANNUNCIATION	ALERT TYPE, POP-UP, CONDITIONS, & VOICE MESSAGE	
GPWS N/A	Alert Type: Caution Pop-up Alert: N/A	
	Condition	Voice Message
	GPWS not available	N/A
	Incorrect TAWS configuration	
	Radar altimeter unavailable	
	GPS position unavailable or degraded	
Internal TAWS-A audio failure exists		
G/S INHB	Alert Type: Advisory Pop-up Alert: N/A Condition: TAWS-A reports glideslope inhibit mode active	
FLAP OVRD	Alert Type: Advisory Pop-up Alert: N/A Condition: TAWS-A reports flap override mode active	

INTENTIONALLY LEFT BLANK

8 Fuel & Engine Indicating System

RECIPROCATING ENGINES

8.1	EIS Display	8-2
8.2	EIS Setup	8-4
8.3	EIS Functions	8-6
8.4	Configuration Report.....	8-19

TURBINE ENGINES

8.5	EIS Display	8-20
8.6	EIS Setup	8-22
8.7	EIS Functions	8-23
8.8	Configuration Report.....	8-35

FUEL

8.9	Fuel Gauges	8-36
8.10	Fuel Computer	8-39

ADVANCED EIS CONFIGURATIONS

8.11	Fuel Balance Monitoring	8-41
8.12	Automatic Ignition.....	8-42
8.13	Gauge-Driven Discrete Outputs	8-43

EIS OPERATIONS

8.14	Record Keeping	8-44
8.15	Flight Operations	8-45

ENGINE ADVISORIES & ALERTS

8.16	Engine Advisories	8-48
8.17	Engine Alerts	8-49

Reciprocating Engines

8.1 EIS Display



The EIS displays engine, electrical, and fuel information using parameter specific indicator types (e.g., analog indicators, digital data fields, bar graphs, horizontal and vertical bar indicators).



Single Engine



Multi-engine

These instruments replace traditional analog gauges used for starting the engine and monitoring performance. For limitations, consult the AFM or POH.

Layout varies according to:

- Display type
- Number of engines in aircraft
- Number and type of installed sensors



GDU 700P



GDU 700L

GDU 700L and GDU 700P present engine instrumentation on a full-screen dedicated display when configured for EIS.

40% 60%



GDU 700L with EIS/MFD

GDU 700() with the EIS/MFD layout present a split view of required engine instrumentation with an MFD function. This configuration supports single-engine aircraft.



Engine Page



Gauge Strip

GDU 1060 presents two views of engine instrumentation: a pilot selectable Engine page on the MFD, and a vertical gauge strip which is always present.

<p>Engine Page</p>	<ul style="list-style-type: none"> • Gauges depicting oil temperature, oil pressure, and fuel flow • Pilot selectable user fields • Graphical depiction of engine CHT/EGT/TIT values [1] • Menu access key • Lean Assist mode function key
<p>Gauge Strip</p>	<ul style="list-style-type: none"> • Unobstructed compact view of engine information • Resides at the left or right edge of the display [2] • No selectable features

[1] Primary EGT and TIT dependent upon aircraft type.
 [2] Location dependent upon configuration.

8.2 EIS Setup

Engine Menu

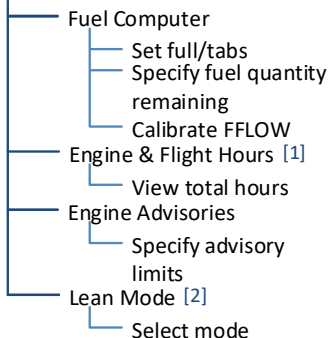

The **Menu** key provides access to the fuel computer, engine and flight hours, engine advisories, and lean modes. On GDU 700(), controls for customizing system settings also reside here.

GDU 700() setup functions are accessible from the System menu. On GDU 1060, they reside on the MFD System page.

System GDU 700()

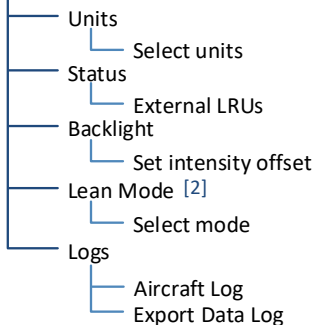

System Page GDU 1060

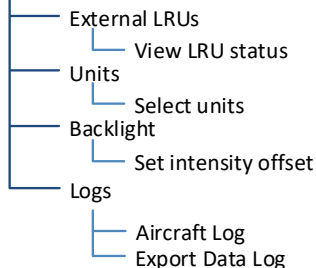

[1] This page is informational only.

[2] Mode selections dependent upon aircraft configuration.

EIS SETUP SELECTIONS

Units	Specify units of measure for fuel computer and pilot selectable gauges. Selections synchronize across all configured GDUs. [1] <ul style="list-style-type: none">• Distance• Fuel Computer• Temperature
Status	<ul style="list-style-type: none">• View unit and software information• Check status of all configured LRUs
Backlight	<ul style="list-style-type: none">• Adjust display brightness
Aircraft Log	<ul style="list-style-type: none">• View engine and airframe cycle counters
Export Data Log	<ul style="list-style-type: none">• Save logged data to SD card
Lean Mode [2]	<ul style="list-style-type: none">• Select Lean Mode from popup menu• Options dependent upon configured engine type

[1] Engine gauge units are not adjustable.

[2] On GDU 1060, this function is accessible from the Engine menu.

8.3 EIS Functions



Common EIS Display Elements

Graphical Indicators	Display a graphical presentation and digital readout of the specified value. [1]
Digital Data Fields	Display a digital readout from the associated sensor. [1] Includes single or dual input values depending on system configuration. Placement corresponds to engine location.
Bar Graphs	Provide digital EGT/TIT and CHT cylinder readings. [2] <ul style="list-style-type: none"> • CHT and EGT digital values are selectable by cylinder • After 10 seconds, CHT values default to the hottest cylinder on each engine
Fuel Quantity Gauges	Display fuel amounts for the specified fuel tanks. [3]
Horizontal and Vertical Bar Indicators	Display instrument information on a single horizontal or vertical bar. Includes single or dual pointers depending on engine type. May include digital readout fields depending on display layout.

<p>Prop Sync Indicator</p>	<p>Provides a visual reference for synchronizing multi-engine RPM. This indicator uses inputs received from the left and right engine tachometer to show a comparison of the matched RPM and the propeller phase angles between two engines.</p> <ul style="list-style-type: none"> • If RPM for both engines is the same, indicator remains stationary • If RPM varies between engines, the indicator rotates in direction of the faster engine <p>The speed at which the indicator rotates is determined by the RPM differential between the two engines.</p>
<p>Selectable User Field</p>	<p>Opens a menu of the selectable data fields available for display. The type of parameters available for selection is determined during installation.</p> <p>A white border differentiates selectable user fields from non-selectable digital data fields.</p>
<p>Lean/Monitor Key</p>	<p>Enables or disables Lean Assist mode.</p> <ul style="list-style-type: none"> • To enable mode and change the name on the key label, tap Lean • To exit mode and return the graph to its normal temperature monitoring mode, tap Monitor <p>Lean Assist mode is required for all engine leaning operations.</p>

- [1] Limits are configured according to system design or the AFM/POH. They are not pilot selectable.
- [2] Primary EGT and TIT indications are dependent upon aircraft type.
- [3] Fuel gauges are configured and calibrated during installation.

8.3.1 Gauge Types

Gauge labels are customizable to match aircraft configuration. Labeling presented in the following table may differ from actual labeling on the unit.

LABEL	UNITS	FUNCTION
RPM	RPM	<ul style="list-style-type: none"> Engine tachometer
MAN	inHg, psi	<ul style="list-style-type: none"> Engine manifold pressure
PWR [1]	%	<ul style="list-style-type: none"> Percent power
Fuel or Fuel Pressure	psi, bar	<ul style="list-style-type: none"> Fuel pressure
FF	gph, lt/hr, PPH, kg/hr	<ul style="list-style-type: none"> Fuel flow
CARB or CARB Temperature	°C, °F	<ul style="list-style-type: none"> Carburetor air temperature Blue arc indicates temperature range where carburetor icing is likely to occur (-15 to 5°C)
Oil or Oil Pressure	psi, HPa, bar	<ul style="list-style-type: none"> Oil pressure
Oil or Oil Temperature	°C, °F	<ul style="list-style-type: none"> Oil temperature
CHT	°C, °F	<ul style="list-style-type: none"> Cylinder head temperature for hottest cylinder (bar indicator) [2]
		<ul style="list-style-type: none"> Graphical representation of CHT for each cylinder [3] Hottest cylinder and cooling rate indications Selectable temperature values on full EIS layouts [4]
CT [5]	°C, °F	<ul style="list-style-type: none"> Coolant Temperature
EGT	°C, °F	<ul style="list-style-type: none"> Graphical representation of exhaust gas temperature for each cylinder [3] Peak EGT Selectable temperature values [6] [7]
		<ul style="list-style-type: none"> Average exhaust gas temperature for engine (Primary EGT) [8]
TIT	°C, °F	<ul style="list-style-type: none"> Turbine inlet temperature
IAT	°C, °F	<ul style="list-style-type: none"> Inlet air temperature
CDT	°C, °F	<ul style="list-style-type: none"> Compressor discharge temperature
IAT CDT Diff	°C, °F	<ul style="list-style-type: none"> IAT, CDT, and IAT/CDT temperature differential

LABEL	UNITS	FUNCTION
Fuel or Main Fuel	lb, lt, gal, kg	• Current fuel quantity in main tanks
Tip Fuel	lb, lt, gal, kg	• Current fuel quantity in tip tanks
Aux Fuel	lb, lt, gal, kg	• Current fuel quantity in auxiliary tanks
Bus Volts	V	• Bus voltage
Bat Volts	V	• Battery voltage
ALT AMPS or ALT %	A, %	• Alternator load
BAT Amps	A	• Battery load
Vac or Vacuum	in Hg, PSI	• Vacuum/Pressure
Rudder or Rudder Trim	° (degrees)	• Rudder Trim

- [1] Cirrus aircraft only.
- [2] EIS gauge strip only.
- [3] Due to limited space, not all cylinders display on EIS/MFD layouts.
- [4] GDU 700() or GDU 1060 Engine page.
- [5] Replaces CHT when coolant temperature sensor is configured.
- [6] Graph labels are dependent upon aircraft configuration (e.g., “E” indicates Primary EGT; “T” indicates TIT).
- [7] EIS gauge strip presents Primary EGT (if installed) or hottest of the individual EGTs.
- [8] Range and units are dependent upon configuration.

STANDARD DIAL GAUGES

Standard round gauges completely replace mechanical gauges and may include additional features such as digital readouts and dynamic gauge markings. Labels vary based on configuration.

Tachometer



Oil Pressure



For aircraft equipped with a starting vibrator, tachometer RPM readings are not accurate during engine cranking. For aircraft that measure engine RPM using P lead sensors, the readings may momentarily fluctuate when selecting operation on a single magneto.

BAR GAUGES

These gauges may display a digital value to the right of the bar indicator.

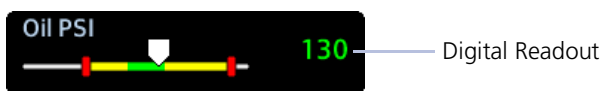

8.3.2 Markings & Indications



NOTE

It is the responsibility of the pilot in command to know and abide by all published limitations and operating ranges in the POH/AFM.

DYNAMIC GAUGE MARKINGS

FEATURE LIMITATIONS

The dynamic gauge feature relies on the installer to configure specific aircraft/engine data. It is possible that not all operating limitations are entered into the EIS system.

Dynamic Gauge Markings

The EIS system is useful for managing engine and aircraft systems within safe operating limits. Dynamic gauges further assist the pilot by presenting only the gauge limits and markings appropriate for the current aircraft conditions. This allows for easier gauge interpretation as well as increased safety and efficiency.

Dynamic gauge range markings change to accommodate non-safe range and alerting parameters. For example, manifold pressure gauge markings may change based on altitude.

Marking Sets

Dynamic markings modify the standard gauge by showing only the pertinent information during a particular flight situation.

Dynamic Markings (Example)

Standard



Configured by the installer to match the existing manifold pressure gauge in the aircraft.

If for any reason the system cannot determine the correct markings to show, the gauge defaults to the standard set.

20,000 ft



Markings adjust to match the maximum manifold pressure for the pressure altitude.

In this example, the maximum manifold pressure decreases as the pressure altitude increases.

24,000 ft



Markings dynamically adjust as pressure altitude thresholds are reached.

Unlike analog gauges, which require you to memorize limitations or interpret multiple markings, dynamic gauges present only the limitations applicable to specific situations or flight conditions.

Gauge range indications are color coded in accordance with their specified operating limits. Units of measure, limits, and gauge colors are configured during installation.

- Amber radial line or arc denotes a caution range
- Red minimum/maximum line or arc denotes a limitation

When an indication is within a colored gauge range, the color of the digital readout will be the same as the range.

NON-SAFE RANGE INDICATIONS & ALERTING

Alert Suppression

The following gauges do not alert when the tachometer indicates less than 100 RPM and the aircraft is on ground.

- Fuel flow
- Fuel pressure
- Manifold pressure
- Oil pressure

To attract attention, engine gauges change appearance when a parameter is within a caution or warning alert band. These non-safe range indications remain active while the gauge is within the alerted range.

For alerting purposes, gauges are split into two groups: engine power and engine performance. Alerting functions differ for each group.

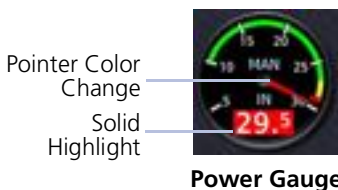

Power Gauge

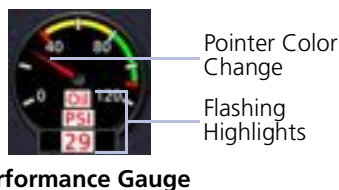

Performance Gauge

GROUP	GAUGE	FUNCTION
Engine Power	Manifold Pressure Tachometer Fuel Flow	<ul style="list-style-type: none"> • Pointer changes color to reflect non-safe operating status. • Readout field turns solid amber or red depending on alert type.
Engine Performance	Oil Pressure [1] Oil Temperature Primary EGT CHT CDT Amps/Volts Fuel Pressure Fuel Quantity	<ul style="list-style-type: none"> • Pointer changes color to reflect non-safe operating status. • Gauge label, readout field, and units (if displayed) flash amber or red depending on alert type. • ACK key flashes (GDU 700() only). • All flashing indications turn solid once the pilot acknowledges the alert. [2]

[1] To minimize the number of nuisance alerts, oil pressure gauges do not flash when within the caution band.
 [2] Alerts automatically acknowledge after 10 seconds on GDU 1060.

8.3.3 EGT/CHT Bar Graphs

The EIS graphically displays CHT and EGT data for each cylinder.

Each bar graph contains the following components.

- Dynamic chart depicting cylinder temperature status
- Digital temperature reading of the highlighted cylinder
- Limit markings

Tapping a graph manually advances the selector to the next temperature value (e.g., CHT, EGT, Primary EGT, or TIT).

- CHT selections revert to auto mode after 10 seconds of inactivity
- EGT values are not selectable during lean assist operations

The size of each graph varies according to aircraft type (i.e., single or twin engine aircraft), the number of cylinders per engine, and gauge configuration (i.e., TIT or primary EGT). Graduations are scaled and sized during installation.

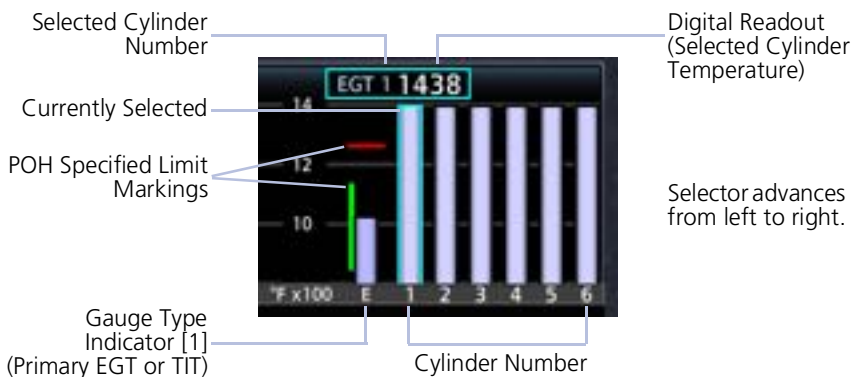

Selector advances from left to right.

[1] Presence and type dependent upon configuration.

SYMBOL	INDICATION	MEANING
	Cyan CHT/EGT Highlight	Currently selected cylinder
	Orange CHT Highlight	Hottest cylinder (automatically selected)
	Single Blue CHT Arrow	CHT is cooling at a rate faster than 30°F (16.7°C) per minute
	Double Blue CHT Arrow	CHT is cooling at a rate faster than 60°F (33.3°C) per minute

8.3.4 Lean Assist Mode

FEATURE REQUIREMENTS

- For specific engine leaning procedures and temperature targets, consult the AFM

FEATURE LIMITATIONS

- Lean mode availability is dependent upon aircraft configuration and engine instrumentation

Selectable lean modes allow you to identify peak EGT/TIT temperatures and temperature differential values associated with the leaning process.

Available mode selections are listed in the Lean Mode menu.

LEAN MODE KEY

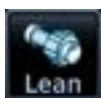

Tapping the **Lean** key once places the EIS in Lean Assist mode.



To return to normal operating mode, tap **Monitor**.

When Lean Assist mode is active:

- EGT graph features are not selectable
- Engine menu is not available
- **Monitor** key displays in the navigation bar
- Mode type annunciates at the bottom of the display

PEAK TEMPERATURE INDICATIONS

During Lean Assist mode, the system waits for the EGT or TIT to peak, and then decrease by a minimum of 6°F. When this occurs:

- The corresponding temperature bar on the graph turns white.
- A white saddle indicates the maximum temperature value recorded for the sensor. In cases where the system waits for the last engine cylinder to peak, violet saddles indicate the maximum temperature of all other peaked cylinders.
- The “PEAK” annunciation and temperature value display in white at the top of the graph. After three seconds, this field reverts to the current operating temperature.
- A numeric field displays the difference between the peak and current operating temperatures. This value changes to reflect all subsequent temperature fluctuations. A negative value denotes an operating temperature lower than the maximum recorded value. A positive value denotes a temperature increase greater than the previously detected peak.
- Saddle position and deviation values automatically adjust to reflect any increases in peak temperature.

ROP Lean

ANNUNCIATION	MODE	FUNCTION
ROP LEAN	Rich of Peak Lean	<ul style="list-style-type: none"> • Indicates the first engine cylinder to reach peak EGT during the leaning process



ROP Lean (Twin Engine Aircraft)

LOP Lean

ANNUNCIATION	MODE	FUNCTION
LOP LEAN	Lean of Peak Lean	<ul style="list-style-type: none"> Indicates the last engine cylinder to reach peak EGT during the leaning process

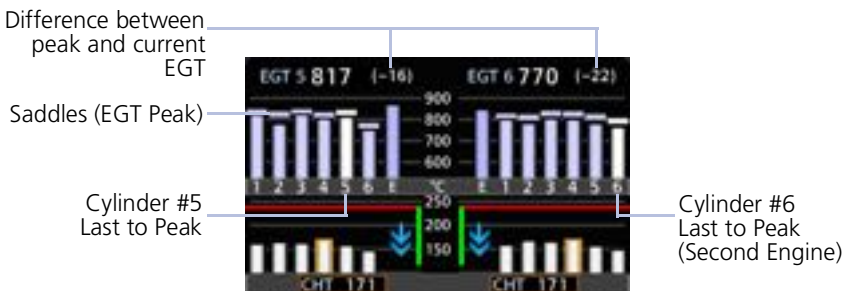

LOP Lean (Twin Engine Aircraft)

EGT Lean

ANNUNCIATION	MODE	FUNCTION
EGT LEAN	Primary EGT Lean	<ul style="list-style-type: none"> Indicates the peak temperature of the primary EGT during the leaning process Available only when Primary EGT is the configured gauge type

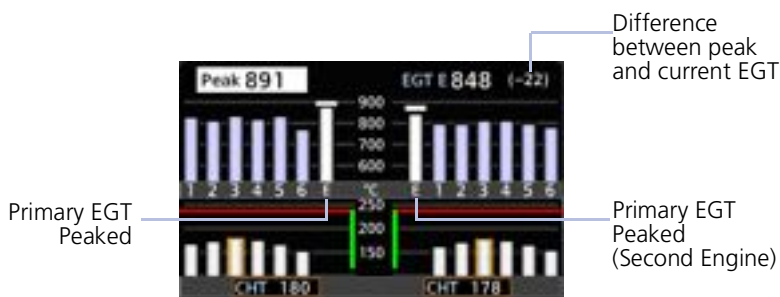

EGT Lean (Twin Engine Aircraft)

TIT Lean

TIT leaning is available for turbocharged aircraft configured for single or dual TIT measurements.

ANNUNCIATION	MODE	FUNCTION
TIT LEAN	Turbine Inlet Temperature Lean	<ul style="list-style-type: none"> Indicates the peak TIT during the leaning process Available only on single turbocharger aircraft
TIT 1 LEAN	Turbine Inlet Temperature Lean First Peak	<ul style="list-style-type: none"> Indicates the first temperature sensor to reach peak TIT Available only on single engine aircraft equipped with dual turbochargers Function resembles ROP Lean
TIT 2 LEAN	Turbine Inlet Temperature Lean Second Peak	<ul style="list-style-type: none"> Indicates the second temperature sensor to reach peak TIT Available only on single engine aircraft equipped with dual turbochargers Function resembles LOP Lean

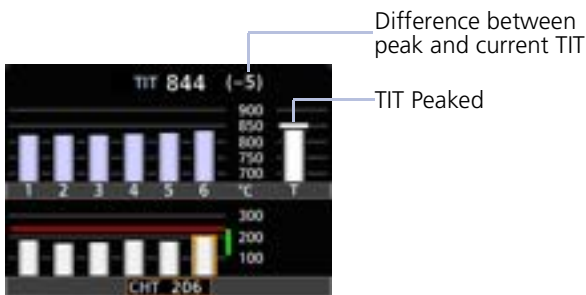

TIT Lean

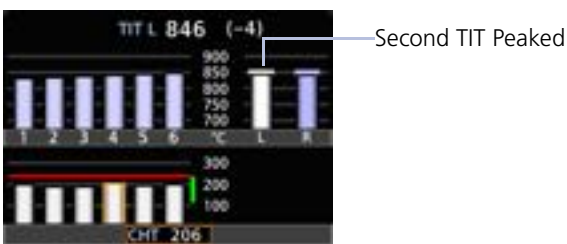

Second TIT Lean

8.3.5 Selectable User Fields

These fields allow you to select engine and fuel parameters for display on the EIS. Available user fields and selectable parameters are determined during installation.

Tapping any user field opens a list of available engine parameters and their current values. Selecting a parameter displays its value on the EIS and closes the menu.

- Fields may be modified to display alternate data at any time
- Several parameter units are pilot adjustable

KEY	DISPLAYS
EST Fuel Remaining	Estimated amount of total fuel remaining [1] [3]
Fuel Used	Total fuel used since last update to estimated fuel remaining quantity [1] [3]
Range	Total range based on remaining fuel and current ground speed [1] [3]
Endurance (HH+MM)	Fuel endurance time in hours+minutes [1]
Fuel at Destination	Estimated fuel amount at current flight plan destination [1] [2] [3]
Endurance at DEST	Remaining fuel endurance time (hours+minutes) at destination [1] [2]
Flight/Hobbs/Tach Hours	Total flight, Hobbs, and tach hours [5]
Efficiency	Fuel efficiency [3]
Outside Air TEMP (ISA)	Degrees deviation from the International Standard Atmosphere model [4]
Outside Air TEMP (SAT)	Outside static air temperature [4]
Outside Air TEMP (TAT)	Outside total air temperature [4]
CHT DIFF	Difference between hottest and coldest CHT for each engine [6]
EGT DIFF	Difference between hottest and coldest EGT for each engine [6]
Percent Power	Percent of maximum rated engine power calculated from manifold pressure, RPM, fuel flow, and outside air temperature

[1] Values are based on fuel computer calculations.

[2] Requires an active flight plan from the navigator.

[3] Parameter units are pilot selectable.

[4] Units are independent of PFD units.

[5] Hobbs hours accumulate when an engine is running. Flight hours accumulate when the aircraft is in air. Tach hours increment at a rate proportional to the configured cruise RPM.

[6] Units are dependent upon configuration.

8.4 Configuration Report

A report detailing all system configuration details, including the different dynamic marking states for each individual gauge, can be provided by your dealer. This information is unique to the aircraft and its configuration.

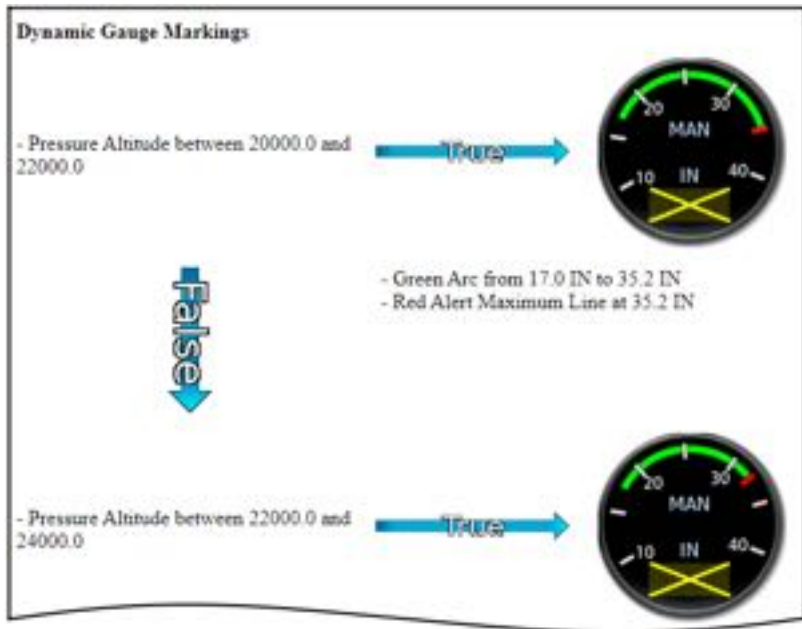

Configuration Report

Use this report to familiarize yourself with the different marking states that are possible with each gauge. To obtain a report, contact your dealer for assistance.

Turbine Engines

8.5 EIS Display



The EIS displays engine, electrical, and fuel information using parameter specific indicator types (e.g., analog indicators, digital data fields, dynamic markings, horizontal and vertical bar indicators).

FEATURE REQUIREMENTS

- GDU 700P configured for turboprop EIS only
- GDU 1060 with turboprop EIS display



GDU 700P

These instruments replace traditional analog gauges used for starting the engine and monitoring performance. For limitations, consult the AFM or POH.

Layout varies according to display type and the number and type of installed sensors.

GDU 700P presents engine instrumentation on a full-screen dedicated display when configured for EIS.



Engine Page



Gauge Strip

GDU 1060 presents two views of engine instrumentation: a pilot selectable Engine page on the MFD, and a vertical gauge strip which is always present.

<p>Engine Page</p>	<ul style="list-style-type: none"> • Expanded information for configured secondary engine gauges • Pilot selectable user fields • Menu access key
<p>Gauge Strip</p>	<ul style="list-style-type: none"> • Unobstructed compact view of primary engine information • Resides at the left or right edge of the display [1] • No selectable features

[1] Location dependent upon configuration.

8.6 EIS Setup

Engine Menu

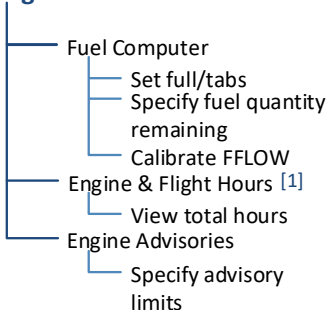

The **Menu** key provides access to the fuel computer, engine and flight hours, and engine advisories. On GDU 700P, controls for customizing system settings also reside here.

GDU 700P setup functions are accessible from the System menu. On GDU 1060, they reside on the MFD System page.

System

GDU 700P

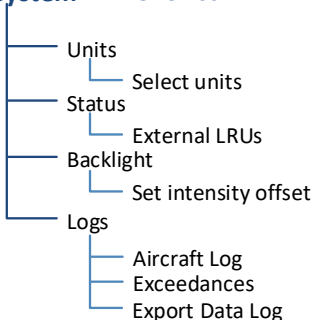

System Page

GDU 1060

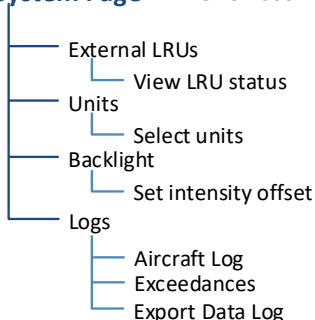

[1] This page is informational only.

EIS SETUP SELECTIONS

Units	<p>Specify units of measure for fuel computer and pilot selectable gauges. Selections synchronize across all configured GDUs. [1]</p> <ul style="list-style-type: none"> Distance Fuel Computer Temperature
Status	<ul style="list-style-type: none"> View unit and software information Check status of all configured LRUs
Backlight	<ul style="list-style-type: none"> Adjust display brightness
Aircraft Log	<ul style="list-style-type: none"> View engine and airframe cycle counters
Exceedances	<ul style="list-style-type: none"> View and acknowledge exceedance advisories
Export Data Log	<ul style="list-style-type: none"> Save logged data to SD card

[1] Engine gauge units are not adjustable.

8.7 EIS Functions

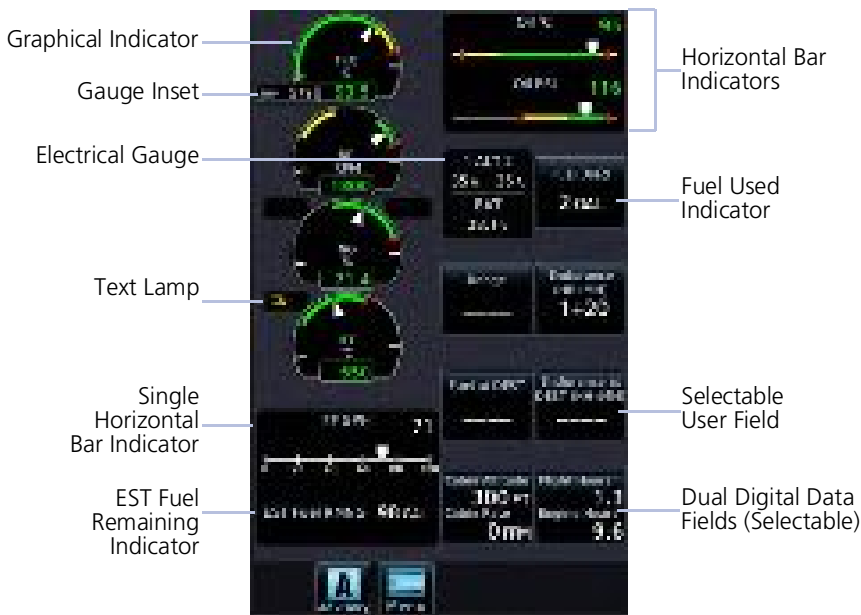

Common EIS Display Elements

<p>Graphical Indicators</p>	<p>Display a graphical presentation and digital readout of the specified value. If configured, these gauges may be accompanied by a text lamp and/or gauge inset. [1]</p>
<p>Digital Data Fields</p>	<p>Display a digital readout from the associated sensor. [1] Includes single or dual input values depending on system configuration.</p>
<p>Fuel Quantity Gauges</p>	<p>Display fuel amounts for the specified fuel tanks. [2]</p>
<p>Horizontal and Vertical Bar Indicators</p>	<p>Display instrument information on a single horizontal or vertical bar. Includes single or dual pointers depending on engine type. May include digital readout fields depending on display layout.</p>
<p>Selectable User Field</p>	<p>Opens a menu of the selectable data fields available for display. The type of parameters available for selection is determined during installation. A gray border differentiates selectable user fields from non-selectable digital data fields.</p>

[1] Limits are configured according to system design or the AFM/POH. They are not pilot selectable.
 [2] Fuel gauges are configured and calibrated during installation.

8.7.1 Gauge Types

Gauge labels are customizable to match aircraft configuration. Labeling presented in the following table may differ from actual labeling on the unit.

LABEL ^[1]	UNITS	FUNCTION
NG	%, RPM	• Engine gas producer speed
NP	%, RPM	• Propeller RPM
TRQ	%, psi, ft-lb	• Engine torque
Engine TEMP	°C, °F	• Turbine engine temperature • Typically inter turbine temp (ITT) or exhaust gas temp
Fuel or Fuel Pressure	psi, bar	• Fuel pressure
FF	gph, lt/hr, PPH, kg/hr	• Fuel flow
Oil or Oil Pressure	psi, HPa, bar	• Oil pressure
Oil or Oil Temperature	°C, °F	• Oil temperature
Fuel or Main Fuel	lb, lt, gal, kg	• Current fuel quantity in main tanks
EST Fuel RMNG	lb, lt, gal, kg	• Estimated fuel based on pilot entered value and fuel flow
Tip Fuel	lb, lt, gal, kg	• Current fuel quantity in tip tanks
Aux Fuel	lb, lt, gal, kg	• Current fuel quantity in auxiliary tanks
Bus Volts	V	• Bus voltage
Bat Volts	V	• Battery voltage
ALT/Gen AMPS or ALT/Gen %	A, %	• Alternator/generator load
BAT Amps	A	• Battery load
Vac or Vacuum	in Hg, PSI	• Vacuum/Pressure
Rudder or Rudder Trim	° (degrees)	• Rudder Trim

[1] Actual gauge labels are dependent upon installer setup.

SUNRISE TURBINE GAUGES

These truncated round gauges have fewer graduations, similar to typical mechanical turbine gauges. Labels may vary based on configuration.

Gas Generator Turbine Speed (N1, NG)



- RPM or % RPM values

Engine Temperature



- Units are °F or °C

Torque



- Units are %, ft-lb, or psi
- Displays up to four whole numbers

Propeller RPM



- RPM or % RPM values

Propeller RPM Minimum Threshold

Depending on aircraft, sensor type, and configuration, this gauge may be configured with a minimum threshold value. During start and shutdown, RPM values below this threshold display as a series of dashes (---). Values above the threshold display as normal.

BAR GAUGES

Bar gauges also display a digital value to the right of the bar indicator.

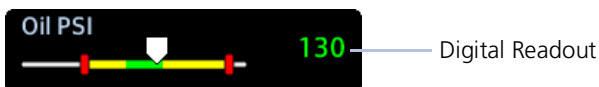

8.7.2 Markings and Indications



NOTE

It is the responsibility of the pilot in command to know and abide by all published limitations and operating ranges in the POH/AFM.

DYNAMIC GAUGE MARKINGS

FEATURE LIMITATIONS

The dynamic gauge feature relies on the installer to configure specific aircraft/engine data. It is possible that not all operating limitations are entered into the EIS system.

Dynamic Gauge Markings

The EIS system is useful for managing engine and aircraft systems within safe operating limits. Dynamic gauges further assist the pilot by presenting only the gauge limits and markings appropriate for the current aircraft conditions. This allows for easier gauge interpretation as well as increased safety and efficiency.

Dynamic gauge range markings change to accommodate non-safe range and alerting parameters. For example, torque gauge markings change based on propeller RPM, while temperature markings change based on engine operating conditions.

Color Indications

Colors are in accordance with their specified operating limits. Units of measure, limits, and gauge colors are configured during installation.

- Amber radial line or arc denotes a caution range
- Red minimum/maximum line or arc denotes a limitation

Marking Sets

Dynamic markings modify the standard gauge by showing only the pertinent information during a particular flight situation or other configured condition.

Dynamic Markings (Example)

Standard



Configured by the installer to match the existing ITT gauge in the aircraft.

If for any reason the system cannot determine the correct markings to show, the gauge defaults to the standard set.

Starting (Condition)



Once the system determines that the engine is starting, the gauge changes to show the starting temperature limits.

In this example, the absolute maximum temperature is absent and the highest red line limit indicates starting maximum temperature.

Running (Condition)



Once the system determines that the engine is running, the gauge changes to show the cruise red line limit.

Starting limit indications are absent.

Unlike analog gauges, which require you to memorize limitations or interpret multiple markings, dynamic gauges present only the limitations applicable to specific situations or flight conditions.

NON-SAFE RANGE INDICATIONS & ALERTING

Alert Suppression

To avoid nuisance alerts while the parameters are in typical ranges for the engine state, flashing is suppressed for fuel pressure, oil pressure, and oil temp when the engine is off or starting.

To attract attention, engine gauge display markings (bands, radials, limitations) change appearance when a parameter is within a caution or warning alert band. These non-safe range indications remain active while the gauge is within the alerted range.

Warning

Caution

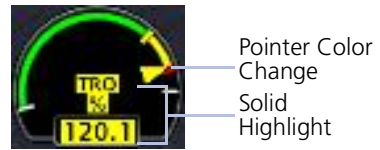
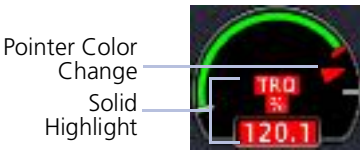

Dynamic Gauge

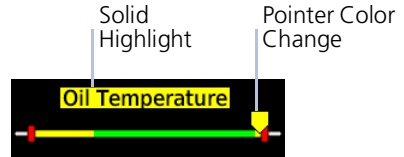
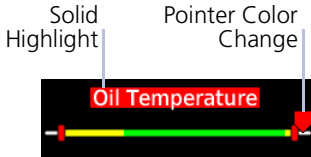

Horizontal Bar Indicator

8.7.3 Additional Gauge Features

TEXT LAMPS

Text lamps are available for the following sunrise gauges:

- Torque
- ITT
- NG
- NP
- Fuel Flow
- Oil Temperature
- Oil Pressure

If configured, sunrise gauges may be accompanied by a text lamp. These windows display a single abbreviated message when the related system is in operation.

These fields appear at the top left of the gauge.



Text color and behavior (i.e., solid or flashing) are dependent upon configuration.

Starter lamps may display a timer.



When the system is inactive, the window is empty.

TEXT	MEANING
START	Starter on
IGN	Ignition on
BETA	Reverse thrust
BLEED	Bleed Valve Closed
INSEP	Inertial Separator Open

Text color and behavior (i.e., solid or flashing) are dependent upon configuration.

When the starter lamp is configured, GDU uses the photocell for display brightness during engine start. This is to ensure EIS visibility as power is drawn to start the engine.

GAUGE INSETS

Gauge insets are available for the following sunrise gauges:

- Torque
- NP

If configured, sunrise gauges may be accompanied by a gauge inset. These windows display a digital readout of secondary information related to the primary gauge for reference.

These fields appear at the bottom left of the gauge.



TEXT	MEANING
SHP	Shaft horsepower
%PWR	Percent power

TIMERS

FEATURE LIMITATIONS

- Timer type, quantity, and availability are dependent upon configuration
- Maximum allowable exceedance time (or grace period) dependent upon configuration

Timers are available for the following gauges:

- Torque
- Prop RPM
- NG/N1
- Turbine Engine Temperature
- Oil Temperature
- Oil Pressure
- Fuel Pressure

Timers indicate the amount of time remaining in the allowable grace period for operation above a limit.

If configured, timers appear at the bottom right of the gauge, adjacent to the parameter field.

Timer exceedances are viewable in the System Logs.

A single gauge may contain multiple timers running simultaneously.

Timer fields always display the parameter with the shortest time remaining. The other timers continue to count down. If a timer expires, the system generates an exceedance log entry for the parameter.

Timers:

- Exceedance
- Engine start/cooldown

Exceedance Timers



Exceedance timers indicate the maximum allowable time that the parameter can operate at an elevated level. This grace period is configured by the installer during initial setup. Depending on the parameter type, the time limit may be based on aircraft or engine manufacturer specifications.

Exceedance Timer Behaviors

- Timer begins counting once the indicated parameter exceeds its threshold
- Timers reset/disappear if the parameter falls below the threshold prior to expiration
- Exceedance recording begins when the timer expires (i.e., once grace period ends)
- Exceedances without a grace period cause the system to record a log entry upon going above the threshold and does not display a timer

Exceedance timers are very useful for recording temperature exceedances during engine starts. For more information about exceedance logging, refer to section 1.32.

Within Range



Timer does not display during normal operating conditions

Above Threshold



Timer displays once the parameter exceeds threshold. Automatic countdown begins.

Approaching Time Limit



Timer begins to flash during the last 5 seconds of the configured grace period.

Warning/Expired



Timer changes color once it reaches zero. It flashes in unison with the alerted gauge pointer, value, and label, indicating a warning condition. Exceedance recording begins.

While the timer counts down, attempt to remedy the exceeding parameter by managing aircraft systems or reducing engine power.

The exceedance timer feature is useful for managing engine and aircraft systems within safe operating limits. The feature relies on the installer to configure specific aircraft/engine data and it is possible not all operating limitations are entered into the EIS system. The pilot in command is responsible to know and abide by all published limitations and operating ranges in the POH/AFM.

Engine Start/CoolDown Timers



- Availability dependent upon configuration
- Start timer counts up from zero when the starter engages
- Starter cooldown timer changes to blue and counts down from zero if the starter engages then disengages without a successful engine start
- May display as a text lamp with a sunrise gauge or as a user-selectable field on the MFD Engine page (depending on configuration)

On MFD: The start timer is available as a user select gauge on the Engine page.



When the starter is active:

- Label changes to show that the starter is “Engaged”
- Timer begins counting up from zero to indicate the amount of time that the starter has been active

When the starter is inactive, the gauge displays underscores.



When the starter switches from active to inactive, but the engine is OFF:

- Timer text turns blue and the label changes to show the starter is in “Cooldown”
- Timer counts down from zero (negative value) to indicate the time since the starter was turned off



When the starter goes from active to inactive, and the engine is in the RUNNING or STARTING state, the annunciation changes to “Ready.”

8.7.4 Selectable User Fields

These fields allows selection of engine and fuel parameters for display on the EIS. Available user fields and selectable parameters are determined during installation.

Tapping any user field opens a list of available engine parameters and their current values. Selecting a parameter displays its value on the EIS and closes the menu.

- Fields may be modified to display alternate data at any time
- Several parameter units are pilot adjustable

KEY	DISPLAYS
EST Fuel Remaining	Estimated amount of total fuel remaining [1] [3]
Fuel Used	Total fuel used since last update to estimated fuel remaining quantity [1] [3]
Range	Total range based on remaining fuel and current ground speed [1] [3]
Endurance (HH+MM)	Fuel endurance time in hours+minutes [1]
Fuel at Destination	Estimated fuel amount at current flight plan destination [1] [2] [3]
Endurance at DEST	Remaining fuel endurance time (hours+minutes) at destination [1] [2]
Flight/Hobbs Hours	Total flight and Hobbs hours [5]
Efficiency	Fuel efficiency [3]
Outside Air TEMP (ISA)	Degrees deviation from the International Standard Atmosphere model [4]
Outside Air TEMP (SAT)	Outside static air temperature [4]
Outside Air TEMP (TAT)	Outside total air temperature [4]
Cabin Altitude/Rate	Cabin altitude and calculated cabin rate [6] [7]
Shaft Horsepower	Engine shaft horsepower
% Power	Engine percent power

[1] Values are based on fuel computer calculations.

[2] Requires an active flight plan from the navigator.

[3] Parameter units are pilot selectable.

[4] Units are independent of PFD units.

[5] Hobbs hours accumulate when an engine is running. Flight hours accumulate when the aircraft is in air.

[6] Units are dependent upon configuration.

[7] Requires cabin altitude data from GFC 600. Rate calculations performed by GDU.

8.8 Configuration Report

A report detailing all system configuration details, including the different dynamic marking states for each individual gauge, can be provided by your dealer. This information is unique to the aircraft and its configuration.

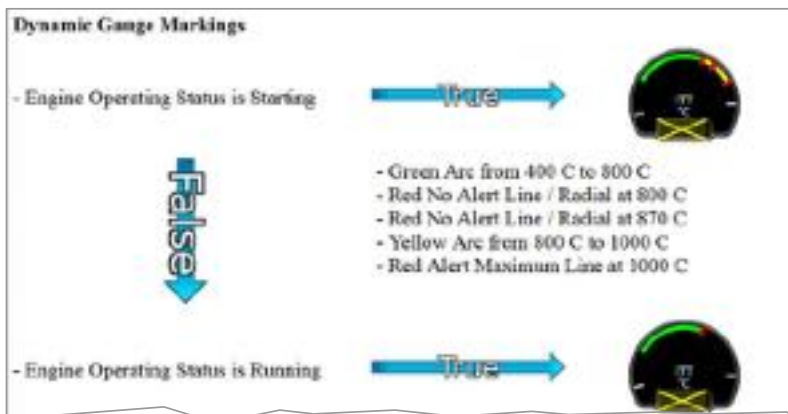

Configuration Report

Use this report to familiarize yourself with the different marking states that are possible with each gauge. To obtain a report, contact your dealer for assistance.

Fuel

8.9 Fuel Gauges

Fuel gauges display the quantity of fuel available in the fuel tanks. There are three basic types of fuel gauge: slider, vertical bar, and digital. The type of gauge depends on GDU and aircraft configuration.

Slider gauges are horizontal bars with one or two moving pointers to indicate fuel quantities. On slider gauges with two pointers, the pointers are labeled to identify the tank locations. Slider gauges may be configured with or without additional digital readouts.

Digital gauges have up to three simple digital readouts to indicate fuel quantities. Two digital gauges may be combined to provide up to six indicators in a single gauge. On the narrow bar gauges available for turbine aircraft using the alternate 11-indicator layout, the digital gauge is limited to two indicators.

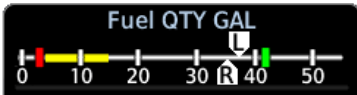

Slider Gauge



Digital Gauge

Vertical bar gauges have up to three filled vertical bars to indicate fuel quantities, with digital readouts above the bars. Two vertical bar gauges may be combined to provide up to six indicators in a single gauge.

GAUGE MARKINGS

A label at the top of each gauge indicates the type of gauge (Fuel QTY) and units of measurement (GAL, LB, LT, or KG). In addition, each fuel tank indicator in a gauge may be customized with a custom tank label up to four characters long. The fuel tank indicators can be arranged in any order. Gauges can also be configured with range markings.

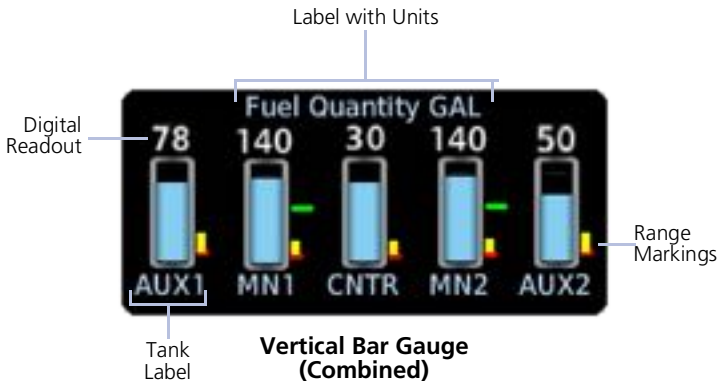

Vertical Bar Gauge (Combined)

VISUAL ALERTS

Gauges with yellow caution range and red minimum alert markings display visual alerts when fuel quantities are within the markings. The gauge label, affected tank label, and digital readout are highlighted in the active range color. On vertical bar gauges, the fill color will also change to the range color. When the gauge enters the range, the visual indicators will flash until the condition is acknowledged. On 1060 PFD/MFD/EIS, alerts are automatically acknowledged after ten seconds.



Visual Range Alerts

GAUGE-DRIVEN DISCRETES

When configured by the installer, the system can send a discrete signal to other aircraft systems based on gauge values or ranges.

FUEL IMBALANCE

Fuel gauges can also be configured to provide visual indication of fuel imbalance. When a fuel imbalance condition is detected, a yellow line will link the affected tanks, the tank label text will change to yellow, and the word “IMBALANCE” or “IMBAL” will be displayed. On slider gauges, the word “IMBAL” is displayed on the side of the gauge adjacent to the lighter tank. When the imbalance is initially detected, indicators flash until the condition is acknowledged. On 1060 PFD/MFD/EIS, alerts are automatically acknowledged after ten seconds. After acknowledgment, the yellow visual indicators will remain until the imbalance is corrected.

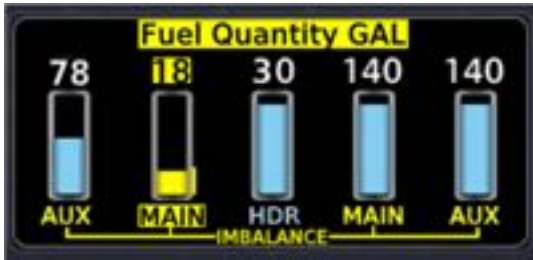

On the narrow strip gauges available for turbine aircraft using the alternate 11-indicator layout, the yellow linking line is replaced with boxes outlining both digital fuel readouts.



SELECTABLE FUEL GAUGES

For aircraft with four fuel tanks but only two selectable fuel quantity signals, selectable fuel gauges are available. Selectable gauges may be either vertical bar or digital types.

Vertical bar selectable gauges display the current fuel quantities for selected tanks and the last known fuel quantities for unselected tanks simultaneously. Unselected tank indicators have gray fill color to indicate that the last known fuel quantity is being displayed, and the digital readout is replaced by a dashed line after ten seconds. If a selectable fuel tank has not been selected since the system was started, the indicator will be filled with gray hash marks to indicate that fuel quantity for that tank has not yet been initialized.



Digital selectable gauges display only the fuel quantities for the currently selected fuel tanks. The digital indicator tank labels change to either MAIN or AUX depending on which tanks are selected. When an indicator is set to an AUX tank, the tank label will be highlighted.



8.10 Fuel Computer



CAUTION

ENSURE THAT ESTIMATED FUEL QUANTITY VALUES IN THE FUEL COMPUTER ARE ACCURATE BEFORE FLIGHT. FUEL QUANTITY GAUGE INDICATIONS MAY NOT PROVIDE THE ACCURACY REQUIRED FOR DETERMINATION OF ON BOARD FUEL DURING FLIGHT.

The fuel computer calculates and displays fuel parameter values when a flight plan is active in a connected and compatible navigator. Calculations are based on GPS ground speed, the pilot specified destination airport, estimated fuel remaining, and inputs received from the engine fuel flow sensor. Fuel parameters are available for display on the EIS in a selectable user field. They include:

- Aircraft endurance
- Endurance at destination
- Fuel used
- Efficiency
- Fuel at destination
- Range

SELECTION	FUNCTION
EST Fuel Remaining	<p>Opens a keypad for specifying the estimated fuel remaining value. The fuel computer bases its calculations on the value entered here.</p> <p>To account for added fuel and maintain accurate fuel flow measurements over time, always update this value upon refueling.</p> <p>This keypad provides additional controls for specifying preset fuel values.</p>
Calibrate FFLOW	<p>Opens the Fuel Flow Calibration page. Controls for calibrating the fuel flow meter reside here.</p> <p>This key remains inactive until a new value is entered for EST Fuel Remaining.</p>

Points About Estimated Fuel Remaining Data

- Based on estimated fuel remaining value entered by the pilot
- Initial value automatically reduced based on current fuel flow
- Not limited to the capacity of the aircraft fuel system
- Preset keys for "full" and "tabs" aid in fuel data entry

Fuel range rings are a pilot-selectable map overlay indicating an estimate of remaining flight distance based on fuel onboard, fuel consumption rates, and current ground speed.

The map depicts two separate rings: an outer yellow ring displaying total endurance range, and an inner dashed green ring displaying range to reserve fuel. These rings offer the pilot additional situational awareness regarding fuel remaining and endurance.

8.10.1 Preset Fuel Quantities

The fuel computer stores preset fuel amounts for estimated full and tab amounts. For the operating limitations of a specific aircraft, consult the POH.

SELECTION	FUNCTION
Full	Sets the fuel remaining value to the specified full amount.
Tab	Sets the fuel remaining value to the specified tab amount.
Set Full/Tabs	<p>Opens the Set Fuel Tabs menu. Select the appropriate data entry key and enter the estimated fuel amounts. These values vary according to aircraft type.</p> <p>Fuel Full Capacity: Specify the tank full amount.</p> <p>Fuel Tab Capacity: Specify a tank tab amount.</p>

8.10.2 Fuel Flow Calibration

A calibration function compares the estimated fuel used amount (calculated by the system) with the actual fuel used amount (determined by the pilot upon refueling). The system calculates a fuel flow correction factor based on these inputs. This adjustment value is applied to future fuel flow calculations.

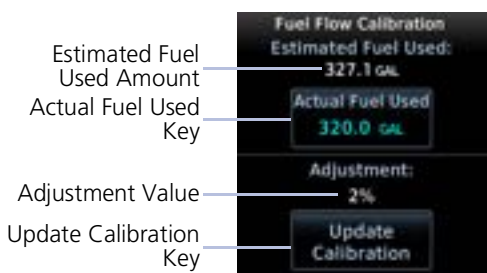

Calibrating the fuel flow meter helps ensure the accuracy of all fuel computer calculations.

SELECTION	FUNCTION
Actual Fuel Used	Allows you to specify the actual amount of fuel used since the last adjustment to the EST Fuel Remaining quantity.
Update Calibration	Updates the current calibration value. Confirming the request re-calibrates the fuel flow meter and saves the new calibration value.

Advanced EIS Configurations

8.11 Fuel Balance Monitoring

FEATURE REQUIREMENTS

- Engine adapter installed (GEA 110 or GEA 71x)
- Installer configuration

FEATURE LIMITATIONS

- Not compatible with selectable fuel gauges

Out of balance fuel loads can trigger visual indications on the affected fuel gauges and activate other aircraft systems.

The fuel imbalance system can monitor up to three pairs of fuel tanks and left and right fuel totals. The system installer can configure these settings for each pair:

- Imbalance monitoring on or off
- Left- and right-heavy discrete outputs
- Maximum imbalance threshold
- Activation threshold
- Activation time delay
- Discrete inhibit signal input
- Fuel imbalance discrete outputs on or off

The system is activated when:

- A monitored pair is out of balance by more than its activation threshold for longer than its time delay.

When the system is activated:

- Fuel gauges provide a visual indication.
- If the imbalance is less than the maximum imbalance threshold, installer configured aircraft systems are activated.

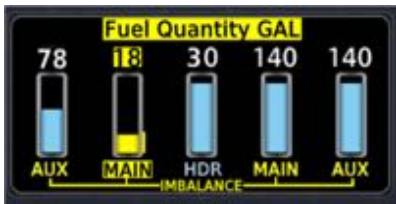

Vertical Bar Gauge Imbalance

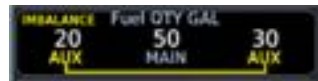

Digital Gauge Imbalance

Fuel transfer pumps, external annunciators, or other aircraft systems can be activated. The installer can also configure a switch or other signal to inhibit the activation of these aircraft systems by the fuel imbalance monitor.

8.12 Automatic Ignition

FEATURE REQUIREMENTS

- GDU 700P/1060 only
- Engine adapter installed (GEA 71x)
- Applicable sensor interfaces configured
- Installer configuration

FEATURE LIMITATIONS

- Turbine only
- The auto ignition feature does not trigger a unique indicator on the GDU. If an ignition text lamp is configured, the ignition indicator will be shown, but does not indicate if the system was activated by the auto ignition system.

This feature automatically switches turbine engine ignition systems on and off based on engine parameters and/or aircraft configuration.

Engine ignition systems that can be switched on and off with an external input can be triggered by a signal from the GDU based on installation-specific configurations.

If a trigger parameter is not available, the automatic ignition feature is disabled and an advisory is displayed. If a parameter becomes unavailable on the ground, a "Service Required" advisory will be displayed. When the aircraft is in the air and the feature is disabled, an "Automatic Ignition Unavailable" advisory will be displayed.

Activation and deactivation conditions are configured separately, and may include multiple AND/OR conditions. Trigger parameters include ITT, NG, NP, torque, condition lever position, and air/ground state. Conditions may also include a delay time.

Example 1:

Auto ignition is switched on when ITT is less than 500°C AND the condition lever is not in cutoff/feather.

Example 2:

Auto ignition is switched off when ITT is more than 500°C for more than 10 seconds.

8.13 Gauge-Driven Discrete Outputs

FEATURE REQUIREMENTS

- Engine adapter installed (GEA 110 or GEA 71x)
- Installer configuration

Gauge-driven discrete outputs are available for the following gauges:

- ITT
- Torque
- Propeller RPM
- NG
- Manifold Pressure
- Fuel Flow
- Oil Pressure
- Oil Temperature
- Vacuum Pressure
- Alt/Gen Amps
- Alt/Gen Volts
- Bus Volts
- Battery Amps
- Battery Volts
- Fuel Quantity
- Engine Power
- Flight Control Trim Position

This feature sends a discrete signal to other aircraft systems based on gauge values or ranges.

Gauge-driven discrete outputs are available with a GDU that is not configured as an EIS. This feature does not require the gauge which drives an output to be displayed.

A single gauge can drive multiple outputs of different configurations.

An output may be triggered when:

- A gauge is at or above, below, or between configured values.
- A parameter is within green, yellow, or red ranges.

EIS Operations

8.14 Record Keeping



NOTE

Do not reboot the GDU during flight unless operational procedures dictate. Doing so may register an additional engine or airframe cycle. Contact a Garmin dealer to adjust counters to match other tracking records.

Counter Types

- Hobbs and flight hours
- Tach hours (piston only)
- Takeoffs and landings
- Starts and shutdowns (turbine only, based on engine data)

Counters record various cycle data, such as takeoffs and landings, Hobbs and flight hours, and tach hours (piston only). These fields always display the counter type with the higher value. For example, if the number of starts is higher than the number of shutdowns, then the number of starts displays.

Counter values are viewable in the System Logs.

ENGINE & AIRFRAME CYCLE COUNTERS

Types include: Takeoffs and Landings; Starts and Shutdowns (based on engine data)

Turbine engine components are life limited by hours of operation and the number of cycles. In the past, aircraft operators would typically record the number of flight hours and operations in a paper logbook. The GDU records this information automatically.

- Takeoffs/landings increment based on GPS, air data, or the weight on wheels discrete
- System records parameters separately on individual counters
- Higher counter value always displays (e.g., if the number of starts is higher than the number of shutdowns, the field displays the number of starts)



GDU stores and displays the information in the aircraft log.

Home > **System** > **Logs** > **Aircraft Logs**

ENGINE AND FLIGHT HOURS



The system records Hobbs, tach (piston only), and flight hours. These parameters may display as a user-selectable field. They are also viewable in the aircraft log.



For convenience, these counters also display at startup.

For twin engine aircraft, dual tach timers are available.

8.15 Flight Operations

PHASE OF FLIGHT	OPERATION
Initial Setup	Customize system settings
	Set fuel full and tank capacity levels
	Set engine advisories
	Calibrate fuel flow
Preflight	Add fuel
En Route	Lean the engine [1]
	Monitor gauges
Post Flight	Record Hobbs and flight hours
	Record tach hours (piston only)
	Record aircraft log and exceedance data [2]

[1] Reciprocating engine only.

[2] Turbine engine only.

8.15.1 Initial Setup

CUSTOMIZE SYSTEM SETTINGS

Specify all necessary EIS settings. Customization options reside in either the System page (GDU 1060) or the System menu (GDU 700()).

SET FUEL FULL AND TAB CAPACITY

Specify estimated fuel full and tab values using the controls in the fuel computer.

SET ENGINE ADVISORIES

Specify engine advisory parameters and limit values.

CALIBRATE FUEL FLOW



NOTE

If the calculated adjustment factor exceeds the 10 percent fuel flow calibration limit, contact your dealer for support.

Calibrate fuel flow using the controls provided in the fuel computer. Re-calibration is recommended following the first flight or any time there is a significant difference between the estimated remaining fuel quantity and the actual amount of fuel in the tanks.

1. Fuel aircraft to a known level (i.e., the bottom of the tabs inside each fuel filler port).
2. Tap **EST Fuel Remaining** and enter the amount of fuel on board.
NOTE: This value must be at least 5 liters (2 gallons) greater than the previous estimated fuel on board amount.
3. Burn no less than 10 percent of usable fuel. Burning more than 10 percent will yield a more accurate calibration.
4. Refuel to the previously entered level.
5. Tap **EST Fuel Remaining** and enter the amount of fuel on board.
6. Tap **Calibrate FFlow**.
7. Enter the amount of actual fuel used. Note the adjustment value.
8. Tap **Update Calibration**.
9. Confirm the request.
10. Acknowledge the pop-up message.

8.15.2 Preflight

ADD FUEL

Update the remaining fuel quantity whenever fuel is added to the aircraft.

1. Fuel the aircraft.
2. Enter the appropriate fuel amount using the fuel computer.

8.15.3 En Route

LEAN THE ENGINE (PISTON ONLY)

1. Select the preferred leaning function from the Lean Mode menu.
2. Tap **Lean**.
3. Monitor the temperatures graph for reference peak events and lean the mixture accordingly.

MONITOR GAUGES

Monitor all gauges. Dynamic gauge limitations may change based on flight conditions.

MONITOR FOR ENGINE EXCEEDANCE ADVISORIES (TURBINE ONLY)

Acknowledge any exceedance advisories occurring in flight and upon landing.

Always operate the aircraft in accordance with the POH.

8.15.4 Post Flight

RECORD AIRCRAFT LOG DATA

Document total Hobbs, tach (piston only), and flight time. If configured, record the number of engine and flight cycles. This information is necessary for logging and maintenance purposes.

EXPORT DATA LOGS

Export flight data and (for turbine) engine exceedance logs to an SD card for later analysis.

Engine Advisories & Alerts

**APPLICABLE TO PISTON &
TURBINE AIRCRAFT**

8.16 Engine Advisories

You can specify values at which the system will advise of certain engine parameters. The system issues an advisory message when an engine gauge exceeds its specified value. These messages are acknowledged in the same manner as system advisories.

Available selections are based on aircraft configuration.

- Low Endurance [1]
- Low Estimate Fuel Remaining [1]
- High/Low Oil Temperature
- High/Low Battery Voltage
- High/Low Bus Voltage
- CHT Cooling Rate [2]
- EGT Differential [2]
- High CHT [2]
- High TIT [2]

[1] Actual amounts are based on fuel computer calculations and an active flight plan.

[2] Reciprocating engine only.

8.17 Engine Alerts



NOTE

Engine warnings require immediate action.

ACKNOWLEDGE ALERT KEY



- Flashes yellow and black when an engine caution is present
- Flashes red and white when an engine warning is present
- Engine alerts display as textual annunciations on the PFD
- Disappears once alert is acknowledged
- Engine cautions and warnings automatically acknowledge after 10 seconds on GDU 1060 with PFD and EIS strip.

Tapping the **ACK** key acknowledges the condition and suppresses all flashing alert indications (i.e., annunciation, gauge). It does not remove the annunciation from the display. Alert annunciations and non-safe range indications remain active (solid) for as long as the gauge is within the alerted range.

ANNUNCIATION	ALERT TYPE, CONDITIONS, AND NOTES	
ENGINE	Alert Type: Warning	
	Condition	Note
	An engine parameter indicates a red alerting range (low or high).	Requires immediate action.
	Alert Type: Caution	
Condition		
An engine parameter indicates a yellow alerting range (low or high).		

REMOTE ENGINE ANNUNCIATIONS

GDU 700()/1060: Engine alerts annunciate on the PFD when the unit is connected to a separate GDU configured for EIS.



Engine Annunciator on PFD

EXTERNAL ENGINE ALERT LAMPS

An external lamp is required if the only EIS display is installed outside the pilot's primary field of view. This lamp illuminates any time an engine alert is active. It turns off once the alert is acknowledged.

9 Abnormal Operations

BACKUP INSTRUMENTS

9.1	Display Backup	9-2
9.2	Backup Battery	9-9
9.3	AHRS & ADC Failures.....	9-14
9.4	HSI Failure Modes.....	9-23

EMERGENCY DESCENT

9.5	EDM Activation	9-27
9.6	EDM Inhibit	9-30
9.7	EDM Override.....	9-32
9.8	EDM Active Discrete Output	9-33
9.9	EDM Failures	9-33

Backup Instruments

9.1 Display Backup

FUNCTIONAL LIMITATIONS

- Applicable to pilot side units only
- Only pilot or center units trigger backup mode when offline
- Not available in single TXi display installations
- Display backup mode supports a limited set of EIS gauges

Display backup mode occurs under these three conditions

- Loss of communication with a GDU that displays EIS or PFD data
- Pilot activation through on-screen selection or toggle switch
- AHRS or ADC fault caused by miscompare or missing data (this only triggers backup mode when the unit is configured as a standby PFD)

Display backup mode attempts to match the configuration of the lost primary display unit. When transitioning, priority is given to the display of primary gauges. In some cases, menu items and lean controls are disabled in this mode. Any flight control trim gauges appear in display backup mode.

An optional external toggle switch allows manual activation of backup mode.

TCAS II RAS

When a GDU 1060 is in display backup mode and providing PFD/MFD/EIS functions, the format of the PFD narrows and the VSI is too small to depict RA bands.

To view TCAS II RAS, tap **Full** on the PFD to expand it to 80%.

9.1.1 Standby PFD Display Options

FEATURE REQUIREMENTS

Additional standby PFD functionality is available in installations that include:

- Dual external ADAHRS sensors: one external ADAHRS; one internal AHRS connected to an ADC
- Two pilot side GDU 700P units: one configured as a dedicated PFD, the other configured as either MFD, EIS, or MFD/EIS
- Non-PFD GDU configured as standby PFD

During display backup, the standby PFD allows you the option of continuing backup PFD mode or returning to the unit's previous display mode (MFD, EIS, or MFD/EIS). This option is available only if display backup is triggered by an AHRS or ADC data mismatch or by pilot activation.

DISPLAY BACKUP KEY

This key remains available during display backup for as long as the GDUs are in communication with each other. It is not available during display backup if only the standby PFD is operational.

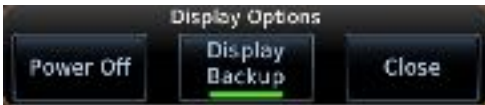

To return the standby PFD to its previous display mode:

1. Push the **Power** key.
2. Deselect **Display Backup**.

9.1.2 Composite Display Backup Mode

When a GDU 700P enters a PFD/EIS composite display backup mode, certain aspects of the normal PFD layout change to accommodate the display of EIS data.

PFD when in composite display backup mode:

- A limited, 90° field of view HSI replaces the Standard HSI or HSI Map
- **CDI** source selection key replaces air temperature and wind data fields
- Attitude background defaults to a blue over brown artificial horizon display (non-SVT)

Removed from display in composite mode:

- Air temperature field
- Clock/timer field
- Wind data fields
- PFD **Menu** key
- **Advisory** key

Unchanged from display in composite mode:

- Airspeed
- Barometric altitude
- Attitude

Unavailable PFD functions operating in composite mode:

- Changing airspeed references
- Setting BARO or RA Minimums
- Selection of AHRS or ADC sources
- Manual adjustment of backlight levels
- Viewing external LRU status



GDU 700P Composite Display in Backup Mode - Reciprocating Engines



GDU 700P Composite Display in Backup Mode - Turboprop Engines

DISPLAY BACKUP MODES



Normal Mode EIS



PFID/MFD



Display Failure



Backup Display Mode



Backup Display Mode



Display Failure

EIS GAUGE REVERSION

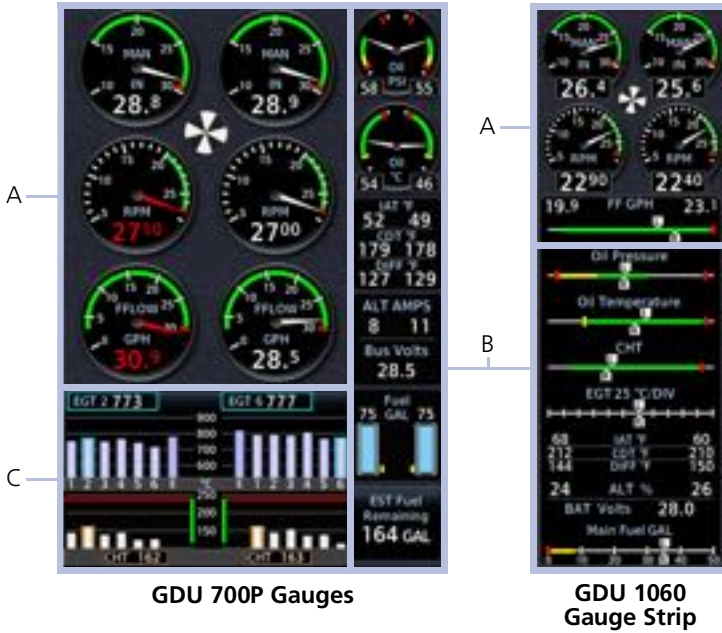

A	Gauges display with little or no change.
B	Gauges transfer depending on priority and open gauge slots.
C	Gauges simplify and transfer, depending on available display area.

TURBOPROP GAUGE AREAS



GDU 700P Gauges

GDU 1060 Gauge Strip

A.	Gauges display with little or no change.
B.	Gauges transfer depending on priority and open gauge slots.
C.	Does not transfer to display backup.

9.2 Backup Battery

FUNCTIONAL LIMITATIONS

- Applicable to GDU 700() only
- During backup battery mode, display brightness is set for minimum sunlight readability

Battery Supported LRUs

- Backup GPS
- GDU 700()
- GEA 110
- GMU 44
- GTP 59
- Integrated ADAHRS

GBB 54 Features

- Lithium-ion battery unit
- Integrated heater ensures performance in low temperatures
- Charged by GDU during normal operations
- Status indications denote battery state and availability
- Pop-up alerts with estimated time remaining
- System advisories with timer display



Icon not present when backup battery is at full charge.







GBB 54 Backup Battery

9.2.1 Battery Status Indications

Status indications include a battery icon and timers.

BATTERY ICON

- Displays when the GBB 54 is powering the GDU, battery charge state is insufficient, or a battery fault exists
- Displays in the annunciator bar and on External LRUs page
- Removed when the battery is at full charge

ICON	STATE	CONDITION
Absent [1]	Charged	<ul style="list-style-type: none"> • Backup battery at full charge (>30 minutes) and available for use.
	Charging/Warming Up	<ul style="list-style-type: none"> • Battery has less than 30 minutes remaining charge. [2] • Battery temperature is below -20°C. [2] [3]
	Discharging	<ul style="list-style-type: none"> • GDU on backup battery power. 15 to 30 minutes remaining.
	Discharging/Caution	<ul style="list-style-type: none"> • GDU on backup battery power. 0 to 15 minutes remaining.
	Discharging/Warning	<ul style="list-style-type: none"> • GDU on backup battery power for longer than 30 minutes. Loss of power may be imminent. [4] • Charge state uncertain (i.e., GDU switches to backup battery power before battery reaches full charge).
	Unavailable/Error	<ul style="list-style-type: none"> • Battery error. Backup battery power is unavailable. • Capacity test is overdue.

[1] A green check on the External LRUs page denotes LRU availability.

[2] Aircraft power is required.

[3] The warm up process can take up to 30 minutes.

[4] A total power loss occurs when aircraft power fails and the backup battery is unavailable or depleted.

BATTERY TIMERS

Battery timers alert the pilot of:

- Transitions from aircraft power to backup battery power
- Total time on battery power

TIMER	ALERT TYPE	CONDITION
Elapsed time on battery power (count-up)	Advisory	Aircraft is in flight.
60 second countdown	Pop-up	Aircraft is on ground or in an unknown state.

Automatic Unit Shutdown

To prevent battery depletion, the unit automatically powers off once the 60 second countdown timer expires.



Tapping **Stay On** cancels the automatic shutdown sequence, allowing the unit to continue operation on backup battery power.

9.2.2 Battery Alerts

Caution messages alerting to backup battery status may display while in flight. On GDU 700L, these alerts are shortened to accommodate space limitations.

ANNUNCIATION	ALERT TYPE & CONDITION
Backup battery in use. Estimated time remaining: 15 minutes.	Alert Type: Caution Pop-up Alert: Yes
	Condition GDU on backup battery power, discharging for 15 minutes.
Backup battery has low charge or fault. See flight manual for operating limitations.	Alert Type: Caution Pop-up Alert: Yes
	Condition
	Battery is charging. Estimated charge is below 30 minutes.
	GDU detects a battery fault or warning state.
	Loss of communication.
	Battery power output failure.
Capacity test failure or testing overdue.	

9.3 AHRS & ADC Failures

The AHRS uses aiding data from the GPS navigator, air data computer, and magnetometer to provide accurate attitude data. Failure of these inputs may cause attitude data to become unavailable. Additional annunciations indicate current alignment and calibration status.

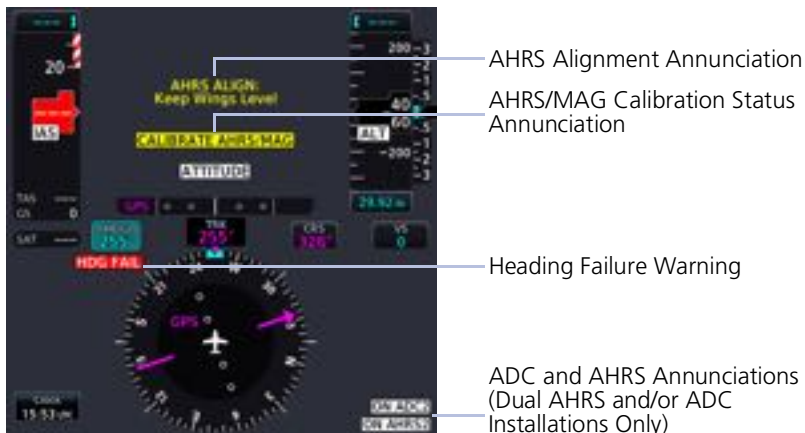

In dual AHRS/ADC installations, use the onside AHRS/ADC during normal operations and the offside AHRS/ADC only when necessary. Under normal conditions, sensor assignment should be as follows.

Pilot PFD: AHRS 1, ADC 1

Co-pilot PFD: AHRS 2, ADC 2

Standby PFD (pilot side): AHRS 2, ADC 2

9.3.1 AHRS and ADC Sensor Selection

The pilot is provided AHRS/ADC source selection controls when dual ADC or AHRS sensors are configured.

SELECT SENSORS ON PILOT/CO-PILOT PFD

Default Selection
(Active)



Alternate Selection
(Active)

AHRS and ADC selection keys reside on the Sensors page of the PFD menu.

Alternate attitude or air data sources annunciate on the PFD. Default selections do not annunciate.

ON ADC2

SELECT SENSORS ON A STANDBY TXI PFD



Default Selections
(Active)

By default, the pilot side standby PFD uses ADC 2 and AHRS 2 data when the unit transitions to backup PFD mode. This occurs during any one of the following conditions.

- Primary PFD failure
- Mismatch state
- No compare state

Pilot Selected
Sensors (Active)



Standby PFD allows you to specify alternate data sources if the default selections are not preferred.



PFD



MFD (Standby PFD)



Display Failure



Sensor Options Available

During backup PFD mode, sensor select options remain available.

Standby PFD Sensor Options

AHRS/ADC SENSOR SELECTION ANNUNCIATIONS

ANNUNCIATION	DISPLAY	DESCRIPTION
SINGLE TXI PFD		
“ON ADC 2” or “ON AHRS 2” (black text on white)	Pilot’s PFD	Pilot selected ADC 2 or AHRS 2 as the sensor source.
TWO TXI PFDS		
“ON ADC 1” or “ON AHRS 1” (black text on yellow)	Standby PFD (pilot side)	GDU is in display backup mode.
	Co-pilot’s PFD	Pilot changed sensor source from the default setting.
“ON ADC 2” or “ON AHRS 2” (black text on yellow)	Pilot’s PFD	
“ON ADC 2” or “ON AHRS 2” (black text on white)	Standby PFD (pilot side)	Sensor source is the default setting (sensor 2).

9.3.2 AHRS Operating In Reversionary Mode

A failure of the air data input has no effect on AHRS output, while AHRS is operating in normal mode. If the air data input fails, while the AHRS is operating in backup No-GPS mode, PFD attitude and heading data are invalid.

9.3.3 GPS Failure

Two GPS inputs may be provided to the AHRS. If GPS information from one of the inputs fails, the AHRS uses the remaining GPS input, and an advisory message informs the pilot. If both GPS inputs fail, the AHRS continues to provide attitude and heading information to the PFD as long as true airspeed data is available and valid.

9.3.4 AHRS Alerts

ANNUNCIATION	ALERT TYPE & CONDITION
HDG FAIL	Alert Type: Warning
	Condition
	Invalid heading.
AHRS ALIGN: Keep Wings Level	Alert Type: Caution
	Condition
	AHRS is aligning. Appears during AHRS initialization.
AHRS NOT READY, DO NOT TAKE OFF	Alert Type: Caution
	Condition
	AHRS is not initialized. Appears prior to AHRS initialization on the ground.
AHRS NOT READY, KEEP WINGS LEVEL	Alert Type: Caution
	Condition
	AHRS is not initialized. Appears prior to AHRS initialization in the air.
CALIBRATE AHRS/MAG	Alert Type: Caution
	Condition
	AHRS calibration is incomplete. Service required. Contact a Garmin dealer for support.
MAG ANOM	Alert Type: Caution
	Condition
	AHRS detects a magnetic anomaly.

ANNUNCIATION	ALERT TYPE & CONDITION
ON ADC <#>	Alert Type: Caution (Dual TXi PFD only)
	Condition
	PFD is using opposite-side ADC data.
	Alert Type: Advisory (Single TXi PFD only)
	Condition
	PFD is using ADC data from ADC 2.
ON AHRS <#>	Alert Type: Caution (Dual TXi PFD only)
	Condition
	PFD is using opposite-side AHRS data.
	Alert Type: Advisory (Single TXi PFD only)
ON AHRS <#>	Alert Type: Advisory (Dual TXi PFD only-Standby PFD only)
	Condition
	PFD is using AHRS data from AHRS 2.
ATTITUDE	Alert Type: Caution
	Condition Flight dynamics monitor detects a possible discrepancy in AHRS outputs.

LRU FAILURE EFFECT ON AHRS OPERATION

LRU	CONDITION	AHRS OUTPUT
ADC	ADC input fails during normal mode.	Valid attitude and heading information (no interruption).
	ADC input fails while AHRS is in NO-GPS mode.	Attitude and heading fails.
GPS Navigator	GPS inputs fail. AHRS continues to operate in No-GPS mode (ADC and magnetometer required).	Valid attitude and heading information (no interruption).
Magnetometer	Magnetometer input fails while aircraft is on the ground. AHRS transitions to back-up mode without magnetometer.	Valid attitude information (no interruption). Heading displays using GPS track data.
	Magnetometer input fails while aircraft is in the air. AHRS transitions to no magnetometer mode.	Valid attitude information (no interruption). Invalid heading information. Display enters reversionary track mode.
GPS and Magnetometer	Magnetometer and GPS inputs fail.	Attitude and heading fails.

9.3.5 Miscompare & No Compare

AHRS/ADC SENSOR COMPARISON

The GDU continuously monitors and compares sensor data when more than one AHRS or ADC is present. A miscompare state occurs when the difference between two or more sensor outputs is above the predefined threshold.

MISCOMPARE THRESHOLDS		
PARAMETER	CONDITION	VALUE
Altitude	All	200 feet
Heading [1]	All	6°
Indicated Airspeed	Both <35 kts	Inhibited
	Either or both ≥ 35 kts, and both <80 kts	10 kts
	Either ≥ 80 kts	7 kts
Lateral Acceleration	All	0.2G
Normal Acceleration	All	0.2G
Pitch Attitude	All	5°
Pitch Attitude Rate	All	1°
Roll	All	6°
Roll Rate	All	3°

[1] Depends upon configuration.

MISCOMPARE ANNUNCIATIONS

Miscompares generate a caution annunciation over the affected PFD instrument(s).



Indicated airspeed, "IAS" annunciates below the airspeed pointer.

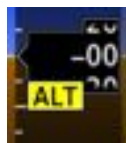

Altitude, "ALT" annunciates below the barometric altitude pointer.



Pitch and/or roll, "ATTITUDE" displays on the pitch scale.



Heading, "HDG" annunciates below the current heading.

In addition to miscompare monitors, the GDU provides an independent flight dynamics monitor that compares computed cross heading, vertical accelerations, and roll angles against reported values generated by the AHRS. If there is a disagreement between the flight dynamics monitor and the AHRS parameters, the "ATTITUDE" caution annunciates.

NO COMPARE ANNUNCIATIONS

A no compare monitor determines when data to the second ADC or AHRS source is unable to be used for comparison.

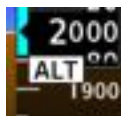
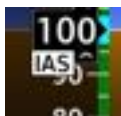

No compares generate an advisory annunciation over the affected instrument(s) driven by ADC and AHRS units.



9.4 HSI Failure Modes



NOTE

TAWS/terrain alerting is unavailable in the absence of a certified GPS source.

The HSI continues to display limited navigation information during magnetometer and GPS failures. If the magnetometer input fails, the AHRS transitions to backup No-Magnetometer mode and continues to output valid attitude information.

If the aircraft is airborne, the PFD heading output reverts to GPS track. Magnetic heading is replaced by GPS track information and HSI compass card orients to GPS track. The following TXi system conditions exist:

- SVT turns off and automatically re-enables when heading is restored
- Map orientations change from HDG UP to TRACK UP
- When heading is restored orientations change back to HDG up
- When heading fails heading bug remains
- GDU continues driving autopilot heading error output using track in place of heading

9.4.1 GPS Failure



WARNING

DO NOT USE PROJECTED POSITION DATA AS THE ONLY MEANS OF NAVIGATION.

When dead reckoning mode is active on the GPS navigator:

- System flags all external outputs dependent on GPS position data
- Map page reports “No GPS Position”; overlays are not available
- DR Mode annunciates on HSI, replacing ENR or OCN
- Traffic and Stormscope data continue to display on their respective pages
- Charts are available for display on the dedicated MFD page, but the ownship is no longer geo-referenced on the chart
- Terrain functionality not available
- CDI not available



Dead Reckoning

9.4.2 Backup GPS

Each GDU is equipped with a backup GPS receiver. When the optional Garmin backup GPS antenna is connected, and if all the certified GPS sources are lost, the system provides 2-D GPS position information from the backup GPS. No pilot action is required to enable the use of backup GPS data.

Only one GDU in a multi-GDU installation requires a connected backup GPS antenna. The system automatically cross-fills backup GPS data between GDUs.

Backup GPS data is used only to provide non-safety critical functions and only after the failure of all certified GPS position sources. Backup GPS data is only provided when a valid GPS position is received from an airborne certified GPS source that is subsequently lost. The system always utilizes time from the backup GPS when no other source is available, even prior to receipt of GPS time from a certified GPS source.

Backup GPS data provides:

- Ownship position on the moving map
- GPS track display
- Waypoint bearing/distance information
- Ground speed
- Wind calculations

When backup GPS is in use:

- Yellow “BACKUP GPS” annunciation displays on all geo-referenced maps
- Navigation using backup GPS is not provided
- Map overlays for Stormscope, traffic, terrain, and obstacles are disabled
- Traffic page continues to display data from TIS-A and TCAS sources

Functions inhibited with backup GPS:

- Bearing pointer on Waypoint Info page
- Chart geo-referencing
- SVT
- GPS altitude displays
- GPS navigation status field
- TAWS/terrain alerting
- Terrain page display

Emergency Descent



GDU offers an Emergency Descent Mode (EDM) that assists pilots of pressurized aircraft in the event of cabin depressurization.



NOTE

While EDM can assist in workload reduction, it is the responsibility of the pilot in command to know and follow all published POH/AFM normal and emergency procedures.

FEATURE REQUIREMENTS

- GDU 700()/1060 PFD
- GFC 600 autopilot configured for EDM
- EDM must be armed in order for activation to occur

FEATURE LIMITATIONS

Availability and the manner in which activation occurs (manual or automatic) are dependent upon configuration.

9.5 EDM Activation



MFD Emergency Application Page

If configured for cabin pressure monitoring, the system monitors cabin pressure once EDM is armed. EDM is considered armed when:

- Autopilot is active
- Aircraft is above 15,000 ft MSL

Once armed, activation may occur manually or automatically.

Contact a Garmin dealer if your installation does not provide access to emergency features.

9.5.1 Manual Activation

WHERE TO FIND IT

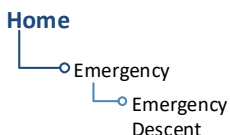

You can activate EDM one of two ways:

From the MFD Home page:

Tap **Emergency** > **Emergency Descent**.

From a dedicated external switch:

Enable the dedicated switch (if configured).

9.5.2 Automatic Activation

If the aircraft experiences decompression and cabin altitude increases beyond the threshold configured for the aircraft, the system automatically triggers EDM.



Upon Activation

The status window displays a warning message and timer.

Emergency descent occurs once the timer expires. This delay can range from 10 to 60 seconds.



If manually activated, you may skip the delay and activate EDM immediately by pressing the emergency descent switch or **Emergency Descent** key a second time.

During Emergency Descent

- Autopilot enters HDG lateral mode
- Aural alert "Emergency Descent, Emergency Descent" repeats every 20 seconds
- HDG bug on PFD sets to 90° to left

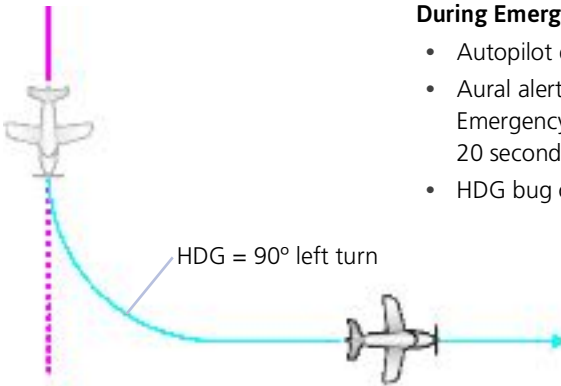

- Simultaneously:
 - Autopilot enters IAS mode
 - PFD sets airspeed bug at V_{MO} and altitude preselect bug to 15,000 ft

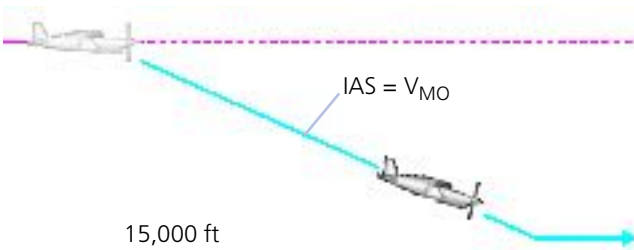

- Aircraft descends at V_{MO}
- Autopilot captures altitude hold mode at 15,000 ft

If available, the pilot may reduce power and deploy speed brakes to increase the rate of descent and reduce the time needed to reach a lower altitude. Ensure that all actions are in accordance with the POH.

EDM ACTIVE INDICATIONS

ANNUNCIATION	STATE
EDM	Active
EDM	Override or Inhibit Mode

During EDM, airspeed and altitude bugs are locked and unchangeable. The active state annunciates in the upper left corner of the PFD.



EDM Selected Data Lockout

9.6 EDM Inhibit

Tapping **Inhibit EDM** prevents automatic activation once the delay timer expires. During inhibit mode:

- Automatic activation remains inhibited for a duration of 5 minutes
- An advisory message with timer counts down the remaining minutes/seconds
- Inhibit state annunciation appears beneath the autopilot banner





EDM Pop-up Warning, PFD

Once the 5 minute inhibit timer expires, the same pop-up warning appears regardless of whether EDM was triggered automatically or by the pilot.

IF	THEN
Pilot triggers EDM and then chooses to inhibit.	Automatic activation remains enabled.
EDM is triggered automatically and the pilot chooses to inhibit.	Manual activation remains available for as long as the aircraft is above 15,000 ft and the autopilot is engaged. [1]
The 5 minute inhibit timer expires and activation conditions are still present.	EDM automatically triggers again.
Pilot loses consciousness after choosing to inhibit the function.	Once the 5 minute inhibit timer expires, EDM automatically activates in order to bring the aircraft to a safer altitude.

[1] Dependent upon configuration.

9.7 EDM Override

To deactivate EDM, disengage the autopilot. You may do this multiple ways:

- On PFD: Tap **Menu > Test > AP Disconnect**.
- On GMC 605: Push the **AP** bezel key.
- On the yoke: Push the AP DISC button.

Activating autopilot will override EDM and return the autopilot to normal operation. In this state:

- EDM does not automatically reactivate until arming conditions are cleared
- An advisory message alerts you to re-pressurize the cabin and reset the autopilot
- Override state annunciation appears beneath the autopilot banner

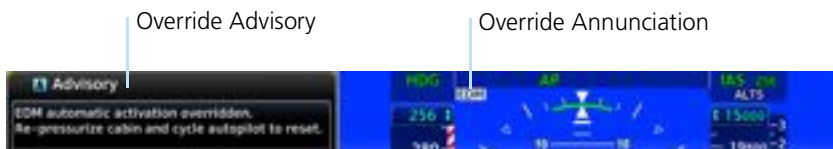

AUTO EDM



This key allows you to manually enable or disable automatic activation. During system power up, this function is active by default.

When the function is off, manual activation of EDM is still available.

To reset EDM automatic activation following an override:

1. Descend below 15,000 ft.
2. Disengage and then re-engage the autopilot.

OR

1. Open the PFD Setup menu.
2. Toggle **Auto EDM** off and on.

Disabling the Auto EDM function may be desired if current cabin conditions are causing erroneous activation of EDM. This can occur when:

- Cabin altitude is above the configured threshold
- GDU reports incorrect cabin altitude

9.8 EDM Active Discrete Output

Active Discrete Output & Engine Torque Control

On the Socata TBM 850, the discrete output may be connected to the engine torque limiter. In such case, turning on EDM would energize the torque limiter circuit, resulting in overtorque protection while the aircraft is in emergency descent mode.

This capability is dependent upon installation and should not be relied upon to maintain the engine within torque limits.

It is the full responsibility of the pilot-in-command to operate the aircraft and engine within the limitations defined in the POH/AFM.

PFD provides a discrete output that allows synchronization of EDM with other systems in the aircraft.

- When EDM is on, the discrete output is active.
- When EDM is off, the output is inactive.

Use of the active discrete output is airframe and installation specific.

9.9 EDM Failures

ANNUNCIATION	ALERT TYPE & CONDITION	
EMERGENCY DESCENT MODE UNAVAILABLE. SERVICE REQUIRED.	Alert Type: Advisory	
	<table border="1"> <thead> <tr> <th data-bbox="336 1062 960 1105">Condition</th> </tr> </thead> <tbody> <tr> <td data-bbox="336 1110 960 1180">EDM is disabled. TXi and GFC 600 V_{NE} configurations do not match.</td> </tr> </tbody> </table>	Condition
Condition		
EDM is disabled. TXi and GFC 600 V _{NE} configurations do not match.		

INTENTIONALLY LEFT BLANK

10 Qualification



NOTE

The procedures described in this section are not authorized for completion during flight. All tasks must be performed while the aircraft is on the ground.

10.1 Glove Qualification

The touchscreen uses capacitive touch technology to sense the proximity of skin to the display. A glove creates a barrier between the skin and the display glass, potentially reducing the ability of the display to detect touches.

This procedure qualifies a specific glove for use with the touchscreen. Due to differences in finger size, glove size, and touchscreen between the GDU 700() and GDU 1060 units, the qualification procedure is specific to the pilot/glove and GDU combination. Multiple units must be evaluated individually.

GLOVE SELECTION CONSIDERATIONS

- Thinner gloves perform better than thicker gloves.
- Leather gloves, and gloves designed specifically for use with capacitive touchscreen devices, are often found to be acceptable.
- To improve touchscreen sensitivity while wearing gloves, use the pad of your finger instead of the tip during touch interactions.

GLOVE QUALIFICATION GUIDANCE

- Checklist 1 contains the tasks required to qualify a glove.
- Checklist 2 contains tasks that are not required to qualify a glove, but may limit how some functions are accessed while wearing a glove.

GLOVE QUALIFICATION STEPS

Complete only the tasks for the capabilities relevant to the installed GDU(s).

1. Sit in the pilot's seat.
2. Start the GDU in normal mode.
3. Perform the tasks listed in each checklist, tapping each key with a non-gloved finger. It is not necessary to record any results for this step.
4. Repeat step 3 using a gloved hand.
5. For each task, determine whether the touchscreen response is the same or worse than without the glove.

Qualification

6. Record the results in the applicable column. Items that may cause the operation to be worse include, but are not limited to:
 - Multiple attempts to select a key
 - Unintentional selection of adjacent key(s)
 - Excessive force on the touchscreen to select a key
7. If all applicable tasks produce the same response with and without a glove, the pilot may use the glove in flight.

GLOVE QUALIFICATION PROCEDURE

Pilot: _____

Glove Description: _____

Circle the applicable TXi GDU and system function(s).

1060 700L 700P / PFD MFD EIS

**CHECKLIST 1
REQUIRED TASKS**

TASK	OPERATION WITH GLOVE (CIRCLE ONE)	
PFD		
Change the current CDI source.	Same	Worse
Tap HDG	Same	Worse
Change AP HDG REF setting.	Same	Worse
Close control menu.	Same	Worse
Tap Barometric Setting Control	Same	Worse
Toggle STD BARO key on and off.	Same	Worse
Close	Same	Worse
Menu	Same	Worse
Minimums	Same	Worse
BARO	Same	Worse
Type a minimums altitude value.	Same	Worse
Enter	Same	Worse
Back	Same	Worse
HSI Setup	Same	Worse
Bearing Pointers	Same	Worse
Toggle Bearing Pointer 1 on and off.	Same	Worse
Back	Same	Worse
PFD Setup	Same	Worse
Clock/Timer	Same	Worse
Enable clock/timer.	Same	Worse
Exit PFD Setup.	Same	Worse

Qualification

TASK	OPERATION WITH GLOVE (CIRCLE ONE)	
Close menu.	Same	Worse
Clock/Timer Control	Same	Worse
Enable timer mode (if necessary).	Same	Worse
Start and stop timer.	Same	Worse
Close control menu.	Same	Worse
Advisory	Same	Worse
Close advisory panel.	Same	Worse
MFD		
Home	Same	Worse
Waypoint Info	Same	Worse
Airport	Same	Worse
Tap WP Identifier key.	Same	Worse
Type a new airport identifier.	Same	Worse
Enter	Same	Worse
Add each of the following waypoints in the same manner.		
KPRC	Same	Worse
LOTKE	Same	Worse
EIS		
For GDUs with integrated EIS only.		
Home	Same	Worse
Engine	Same	Worse
Advance selector through each EGT/TIT cylinder.	Same	Worse
Toggle Lean Mode key on and off.	Same	Worse
Menu	Same	Worse
Engine Advisories	Same	Worse
Type a temperature value for the High Oil TEMP advisory.	Same	Worse

TASK	OPERATION WITH GLOVE (CIRCLE ONE)	
Enter	Same	Worse
Return temperature value to its previous setting.	Same	Worse
Back	Same	Worse
Engine & Flight Hours	Same	Worse
Back	Same	Worse
Exit menu.	Same	Worse

**CHECKLIST 2
NON-REQUIRED TASKS**

TASK	OPERATION WITH GLOVE (CIRCLE ONE)	
PFD		
Menu	Same	Worse
HSI Setup	Same	Worse
Enable HSI Map.	Same	Worse
Exit menu.	Same	Worse
With one finger on the map, swipe up to zoom in, swipe down to zoom out.	Same	Worse
MFD		
Open the Map page.	Same	Worse
With two fingers on the map, stretch to zoom in, pinch to zoom out.	Same	Worse
With one finger on the map, swipe in any direction to pan.	Same	Worse
Menu	Same	Worse
Map Setup	Same	Worse
Drag to the bottom of the Map tab list.	Same	Worse
LAT/LON Lines	Same	Worse
Exit menu.	Same	Worse
EIS		
None.		

11 Glossary

A

ACT	Altitude Compensated Tilt
ADAHRS	Air Data/Attitude & Heading Reference System
ADC	Air Data Computer
ADF	Automatic Direction Finding Equipment
ADI	Attitude and Direction Indicator
ADIZ	Air Defense Identification Zone
ADS-B	Automatic Dependent Surveillance Broadcast
AFM	Aircraft Flight Manual
AFMS	Aircraft Flight Manual Supplement
AGL	Above Ground Level
AHRS	Attitude Heading Reference System
AIM	Airman's Information Manual
AIRB	Basic Airborne Application
ALT	Altitude Hold
AP	Autopilot
ATC	Air Traffic Control
ATCRBS	Air Traffic Control Radar Beacon System
ATK	Along Track

C

CAT	Carburetor Air Temperature
CDI	Course Deviation Indicator
CDU	Control and Display Unit
CHT	Cylinder Head Temperature
CRS	Course
CTAF	Common Traffic Advisory Frequency
CWA	Center Weather Advisory

D

DG	Directional Gyro
DH	Decision Height
DME	Distance Measuring Equipment

E

EDM	Emergency Descent Mode
ECR	Excessive Closure Rate
EDR	Excessive Descent Rate
EGT	Exhaust Gas Temperature
EIS	Engine Information System
ENR	En Route
ESP	Electronic Stability and Protection

F

FAF	Final Approach Fix
FDC	Flight Data Center
FIS-B	Flight Information Services Broadcast
FIT	Flight Into Terrain
FLTA	Forward Looking Terrain Avoidance
FMS	Flight Management System
FPM	Feet Per Minute
FS	Flight Stream

G

GCS	Ground Clutter Suppression
GDC	Garmin Air Data Computer
GDL	Garmin Data Link
GDU	Garmin Display Unit
GEA	Garmin Engine and Airframe
GFC	Garmin Flight Controller
GP	Glidepath

GPS	Global Positioning System
GPSS	Global Positioning System Steering
GPWS	Ground Proximity Warning System
GRS	Garmin Reference System
GS	Glideslope
GSL	Geometric Sea Level
GSU	Garmin Sensing Unit
GTP	Garmin Temperature Probe
GWX	Garmin Weather Radar

H

HDG	Heading
HOT	Hazardous Obstacle Transmission
HSI	Horizontal Situation Indicator
HTAWS	Helicopter Terrain Awareness and Warning System

I

IAF	Initial Approach Fix
IAS	Indicated Airspeed
IAT	Induction Air Temperature
IFR	Instrument Flight Rules
IGRF	International Geomagnetic Reference Field
ILI	Imminent Line Impact
ILS	Instrument Landing System
ITT	Interstage Turbine Temperature
IOI	Imminent Obstacle Impact
ISA	International Standard Atmosphere
ITI	Imminent Terrain Impact

K

KIAS	Knots Indicated Airspeed
------	--------------------------

L

LDI	Lateral Deviation Indicator
LOA	Letter of Authorization
LOC	Localizer
LRU	Line Replaceable Unit

M

MAP	Missed Approach Point
MAHP	Missed Approach Holding Point
MDA	Minimum Descent Altitude
METAR	Meteorological Terminal Aviation Routine Weather Report
MFD	Multi-Function Display
MGT	Measured Gas Temperature
MOA	Military Operations Area
MSL	Mean Sea Level

N

NAVAID	Navigation Aid
NCR	Negative Climb Rate
NDB	Non-Directional Beacon
NEXRAD	Next-Generation Radar
NRST	Nearest

O

OAT	Outside Air Temperature
OBS	Omni Bearing Selector
OCN	Oceanic

P

PCL	Pilot Controlled Lighting
PDA	Premature Descent Alert
PFD	Primary Flight Display
PVT	Position, Velocity, and Time

R

RLC	Reduced Line Clearance
ROC	Reduced Required Obstacle Clearance
RTC	Reduced Required Terrain Clearance

S

SAT	Static Air Temperature
SBAS	Satellite-Based Augmentation System
SD	Secure Datacard
SSID	Service Set Identifier
SURF	Surface Situation Awareness
SVT	Synthetic Vision Technology
SXM	SiriusXM Weather

T

TA	Traffic Advisory
TAF	Terminal Aerodrome Forecast
TAS	Traffic Advisory System
TAT	Total Air Temperature
TAWS	Terrain Awareness and Warning System
TCAD	Traffic Alert and Collision Avoidance Devices
TCAS	Traffic Alert and Collision Avoidance System
TERM	Terminal
TFR	Temporary Flight Restriction
TIS	Traffic Information Service
TIT	Turbine Inlet Temperature
TSO	Technical Standard Order

U

UTC	Universal Time Coordinated
-----	----------------------------

V

VDI	Vertical Deviation Indicator
VFR	Visual Flight Rules
VLOC	VOR/Localizer
VNAV	Vertical Navigation
VOR	Very High Frequency Omni-directional Range
VRP	Visual Reporting Point
VS	Vertical Speed
VSI	Vertical Speed Indicator

W

WAAS	Wide Area Augmentation System
WATCH	Weather Attenuated Color Highlight
WP	Waypoint

